

ARTERIENKLEMMEN, PRÄPARIERKLEMMEN
HEMOSTATIC- AND DISSECTING FORCEPS
PINCES HEMOSTATIQUES ET A PREPARATION
PINZAS HEMOSTATICAS Y PARA PREPARACIONES
PINZE EMOSTATICHE E PER PREPARAZIONE

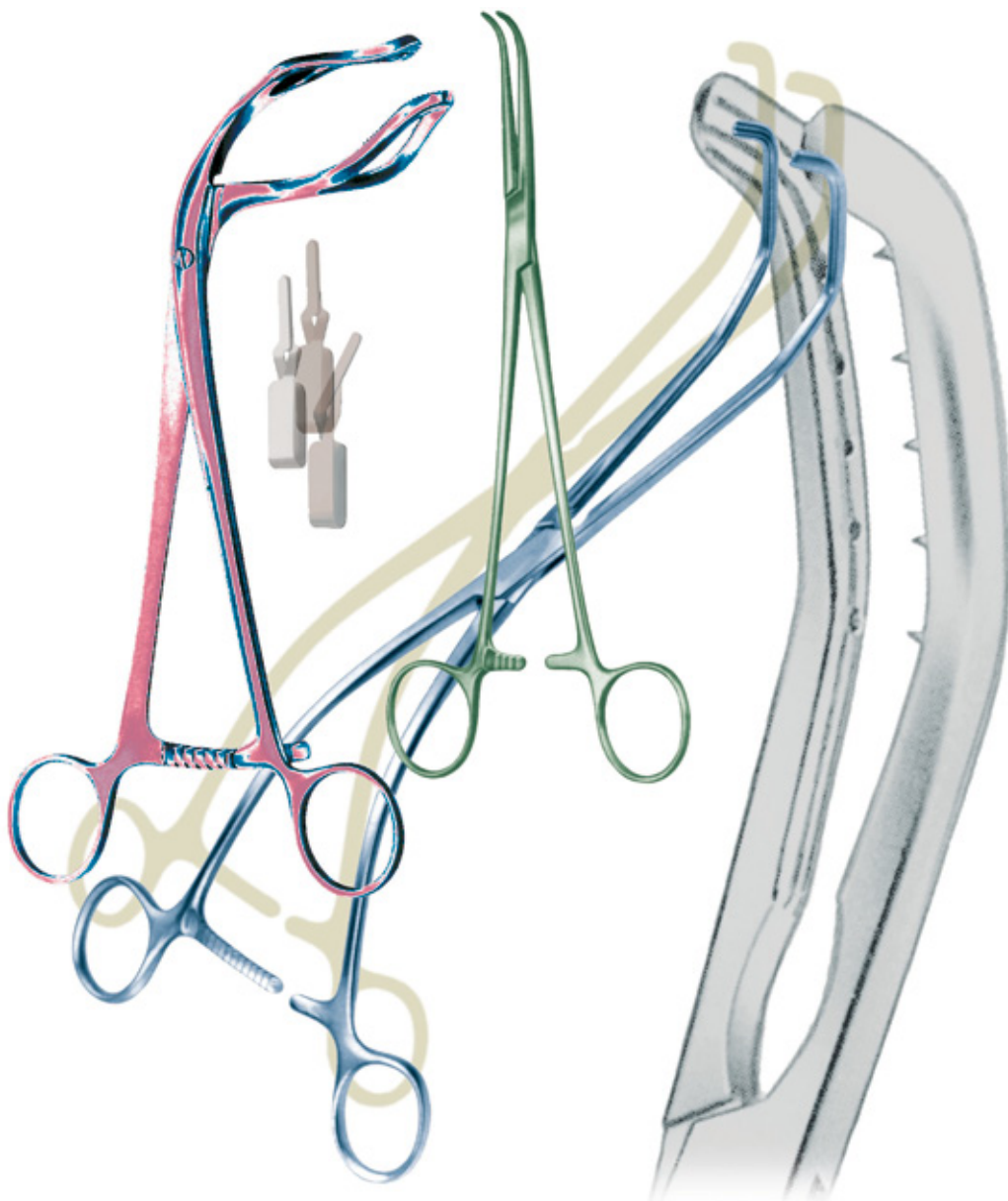

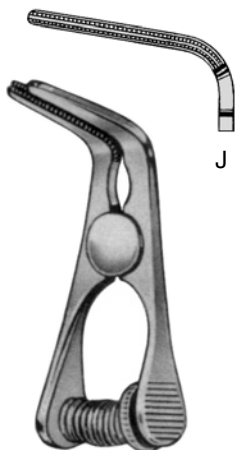

GLOVER



GLOVER

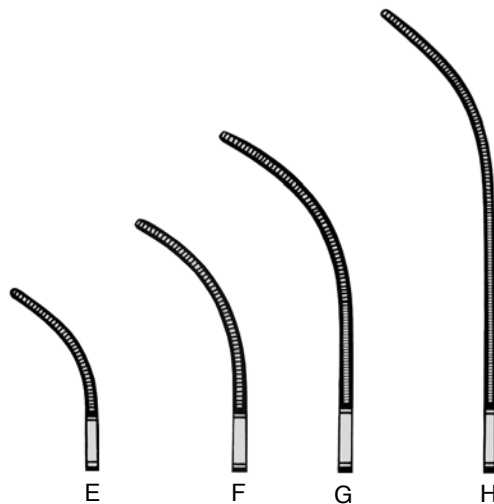

Artikel Item	Fig.	Gesamtlänge Overall length Longeur complet largo total Lunghezza total	Maullänge Jaw length longeur de mors largo de boca Lunghezza del morso	Gewicht Weight Poids Peso Peso
41.0000	A	60 mm	20 mm	5 g
41.0001	E	55 mm	20 mm	5 g
41.0005	B	70 mm	30 mm	9 g
41.0006	F	65 mm	30 mm	9 g
41.0010	C	90 mm	43 mm	12 g
41.0011	G	85 mm	43 mm	12 g
41.0015	D	105 mm	56 mm	14 g
41.0016	H	100 mm	56 mm	14 g
41.0019	J	55 mm	25 mm	7 g

ATRAUMATISCHE BULLDOGKLEMMEN
NON-TRAUMATIC BULLDOG CLAMPS
CLAMPS BULLDOG NON-TRAUMATISANTS
CLAMPS BULLDOG ATRAUMATICAS
CLAMPS ATRAUMA BULLDOG



GREGORY

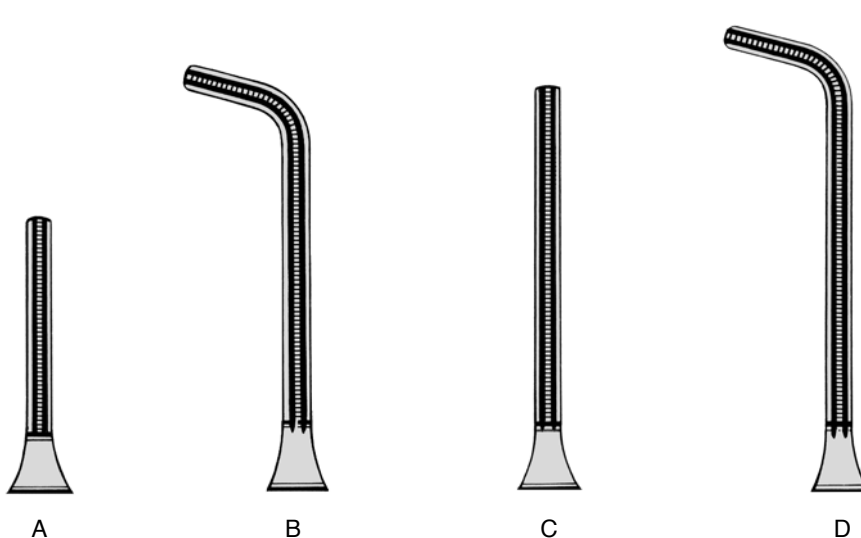

Artikel Item	Fig.	Gesamtlänge Overall length Longeur complet largo total Lunghezza total	Maullänge Jaw length longeur de mors largo de boca Lunghezza del morso	Gewicht Weight Poids Peso Peso
41.0020	A	90 mm	27 mm	11 g
41.0021	B	100 mm	44 mm	12 g
41.0022	C	110 mm	55 mm	12 g
41.0023	D	110 mm	60 mm	12 g



GREGORY

nach links gebogen
 curved to left
 courbe à gauche
 curva a la izquierda
 curvo a sinistra



nach rechts gebogen
 curved to right
 courbe à droit
 curva a la derecha
 curvo a destra



Artikel Item	Fig.	Gesamtlänge Overall length Longeur complet largo total Lunghezza total	Maullänge Jaw length longeur de mors largo de boca Lunghezza del morso	Gewicht Weight Poids Peso Peso
41.0024	A	110 mm	60 mm	12 g
41.0025	B	110 mm	60 mm	12 g

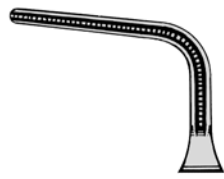

30 mm Maullänge
 Jaw length
 longueur de mors
 largo de boca
 Lunghezza del morso

SANTULLI
41.0028
 70 mm



DIETRICH



A



B



C



D

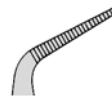

E

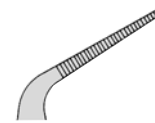

F

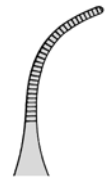

G

Artikel Item	Fig.	Gesamtlänge Overall length Longeur complet largo total Lunghezza total	Maullänge Jaw length longueur de mors largo de boca Lunghezza del morso	Gewicht Weight Poids Peso Peso	Schliessdruck Closing pressure Pression d'Occlusion Presión de cierre Pressione di chiusura
41.0030	A	50 mm	8 mm	3 g	80
41.0031	D	43 mm	8 mm	3 g	80
41.0032	B	53 mm	12 mm	3 g	80
41.0033	E	45 mm	12 mm	3 g	80
41.0034	C	60 mm	20 mm	3 g	80
41.0035	F	50 mm	20 mm	3 g	80
41.0037	G	54 mm	20 mm	3 g	80

ATRAUMATISCHE BULLDOGKLEMMEN
NON-TRAUMATIC BULLDOG CLAMPS
CLAMPS BULLDOG NON-TRAUMATISANTS
CLAMPS BULLDOG ATRAUMATICAS
CLAMPS ATRAUMA BULLDOG



DEBAKEY-MICRO

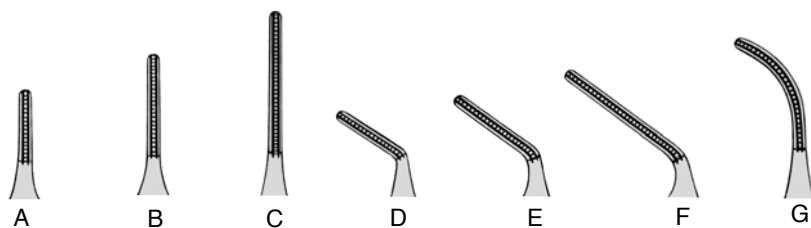

Artikel Item	Fig.	Gesamtlänge Overall length Longeur complet largo total Lunghezza total	Maullänge Jaw length longeur de mors largo de boca Lunghezza del morso	Gewicht Weight Poids Peso Peso	Schliessdruck Closing pressure Pression d'Occlusion Presión de cierre Pressione di chiusura
41.0090	A	47 mm	10 mm	3 g	180
41.0091	D	44 mm	10 mm	3 g	180
41.0092	B	51 mm	14 mm	3 g	180
41.0093	E	46 mm	14 mm	3 g	180
41.0094	C	57 mm	20 mm	3 g	180
41.0095	F	49 mm	20 mm	3 g	180
41.0099	G	54 mm	20 mm	3 g	180

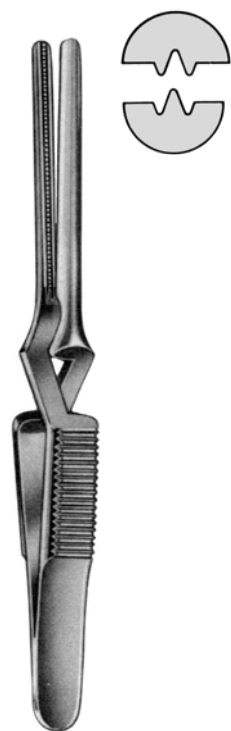

DEBAKEY

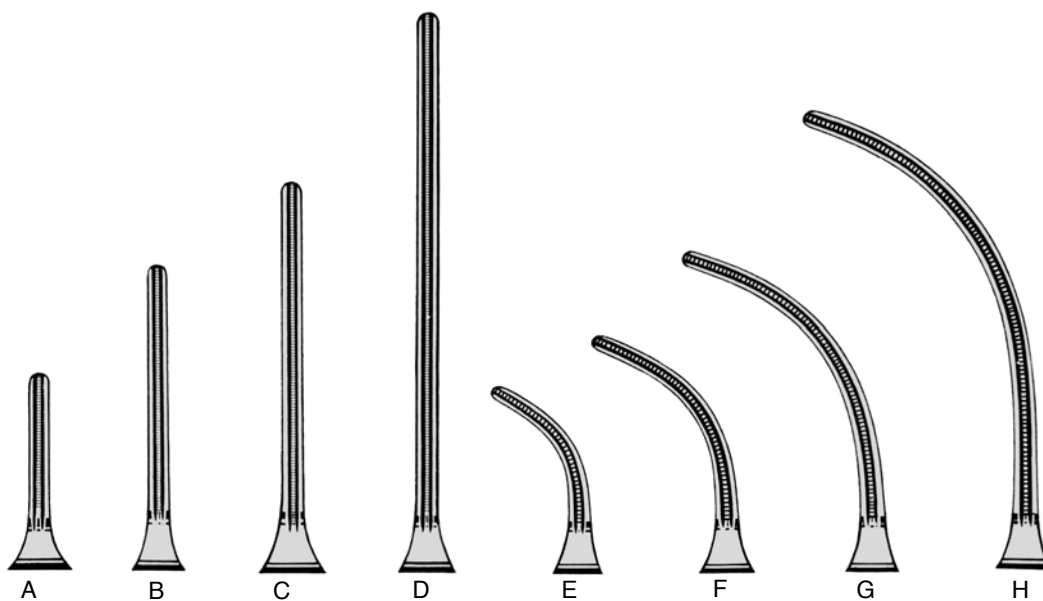

Artikel Item	Fig.	Gesamtlänge Overall length Longeur complet largo total Lunghezza total	Maullänge Jaw length longeur de mors largo de boca Lunghezza del morso	Gewicht Weight Poids Peso Peso
41.0100	A	80 mm	20 mm	10 g
41.0101	E	75 mm	20 mm	10 g
41.0110	B	90 mm	30 mm	11 g
41.0111	F	85 mm	30 mm	11 g
41.0115	C	105 mm	45 mm	12 g
41.0116	G	95 mm	45 mm	12 g
41.0120	D	125 mm	68 mm	12 g
41.0121	H	115 mm	68 mm	12 g



CARREL
 15.0098 8,5 cm



HARTMANN
 10 cm



15.0108
 glattes Maul
 smooth jaws
 lisses
 lisas
 liscio



HARTMANN
 15.0101 10 cm

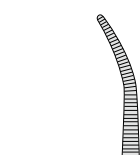
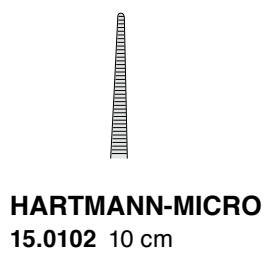

HARTMANN-MICRO
 15.0103 10 cm



HARTMANN
 15.0104 10 cm 1x2



HARTMANN
 15.0105 10 cm 1x2

ARTERIENKLEMMEN
HEMOSTATIC FORCEPS
PINCES HÉMOSTATIQUES
PINZAS HEMOSTÁTICAS
PINZE EMOSTATICHE



15.0117

JACOBSON-MICRO
 15.0116 12,5 cm

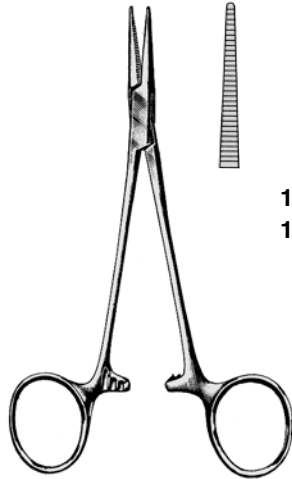

15.0121 12,5 cm
 15.0125 14 cm

MOSQUITO
 15.0120 12,5 cm
 15.0120L 12,5 cm
 linkshändig / left-handed
 pour gaucher / para zurdo / per mano sinistra
 15.0124 14 cm



15.0121L
 linkshändig
 left-handed
 pour gaucher
 para zurdo
 per mano sinistra

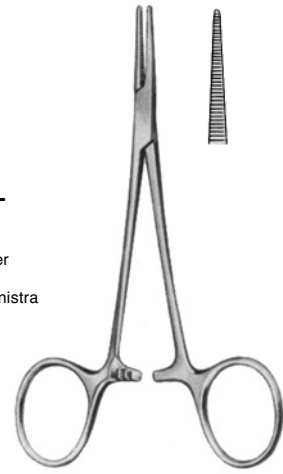

15.0123

MICRO-MOSQUITO
 15.0122 12,5 cm



15.0129 1x2

MICRO-MOSQUITO
 15.0128 12 cm 1x2



15.0127 12,5 cm 1x2
 15.0137 14 cm 1x2

MOSQUITO
 15.0126 12,5 cm 1x2
 15.0136 14 cm 1x2



MICRO-MOSQUITO
 15.0139 12,5 cm
 kreuzgerieft / cross-serrated
 rainures croisées
 estriada en forma de cruz
 striatura cruciforme

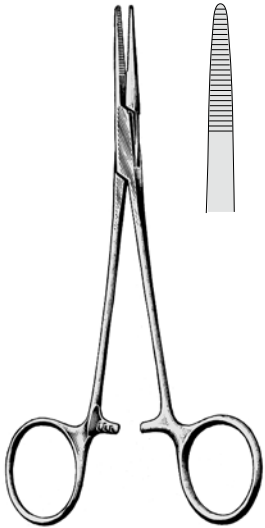

15.0131

PROVIDENCE-HOSPITAL
 15.0130 14,5 cm



15.0181

DUNHILL
 15.0180 12,5 cm

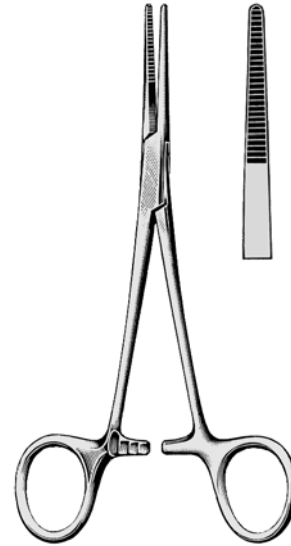

15.0201

KELLY
 15.0200 14 cm

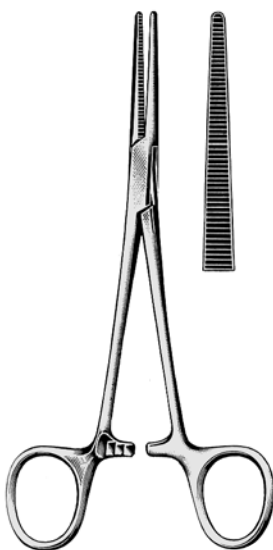

CRILE
 15.0210 14 cm



15.0211

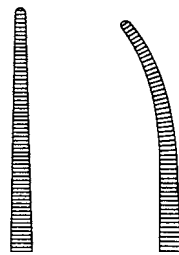

15.0212

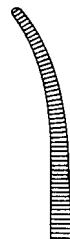

15.0213



15.0214 1x2



15.0215 1x2

CRILE-BABY

ARTERIENKLEMMEN
HEMOSTATIC FORCEPS
PINCES HÉMOSTATIQUES
PINZAS HEMOSTÁTICAS
PINZE EMOSTATICHE



15.0240

15.0241

RANKIN-KELLY
 16 cm



15.0251

RANKIN-CRILE
 15.0250 16 cm



15.0253
1x2

RANKIN-CRILE
 15.0252 16 cm 1x2



15.0260
14 cm

15.0262
16 cm

15.0261
14 cm

15.0263
16 cm

COLLER-CRILE

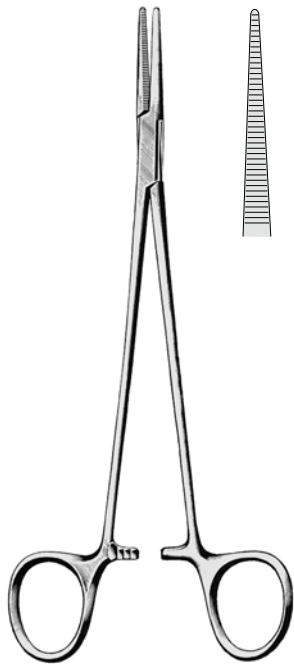

HALSTED
 15.0300 18 cm
 15.0302 21 cm

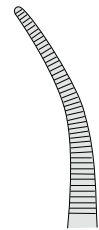
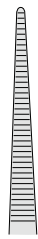

15.0301 18 cm
 15.0303 21 cm



15.0306 18 cm 1x2
 15.0308 21 cm 1x2

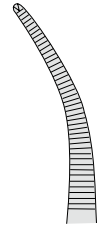

15.0307 18 cm 1x2
 15.0309 21 cm 1x2



ADSON-BABY
 15.0313 14 cm



15.0315
 18 cm

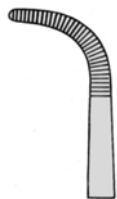

ADSON
 15.0310 18,5 cm



15.0311

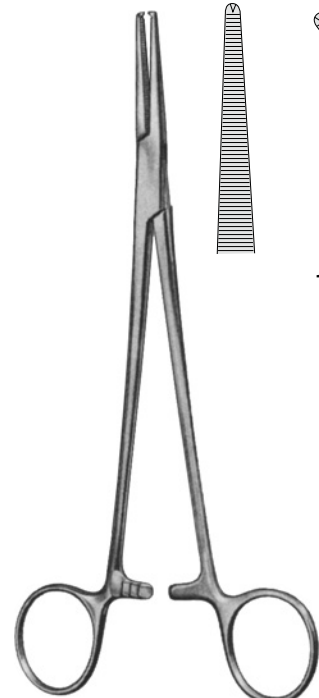
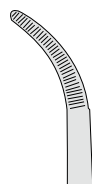

ADSON
 15.0316 18,5 cm 1x2

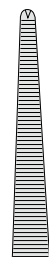

15.0317 1x2

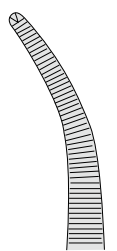

PRÄPARIER- UND LIGATURKLEMMEN
 DISSECTING AND LIGATURE FORCEPS
 PINCES A DISSEQUER ET A LIGATURES
 PINZAS PARA DISECCION Y LIGATURAS
 PINZE PER PREPARAZIONI E LEGATURE



HEISS
 15.0320 20 cm



15.0321



15.0323



15.0324
 1x2



15.0325
 1x2



FUCHSIG
 15.0331 18,5 cm

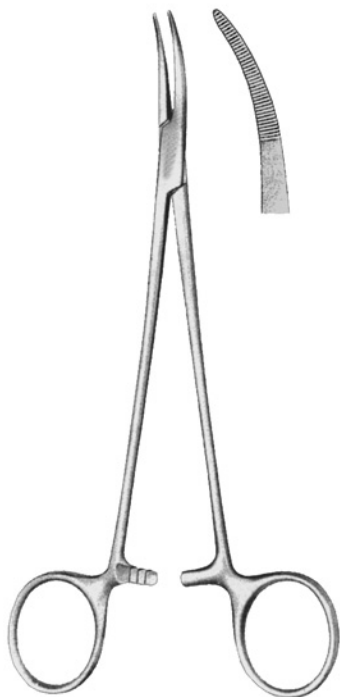
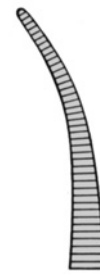

NISSEN
 15.0335 19 cm

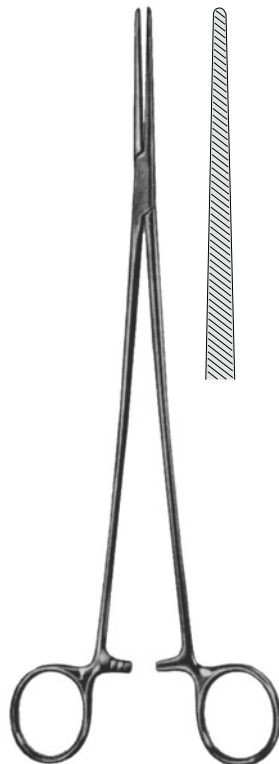

BENGOLEA
 15.0360 20 cm
 15.0362 26 cm



15.0361 20 cm
 15.0363 26 cm

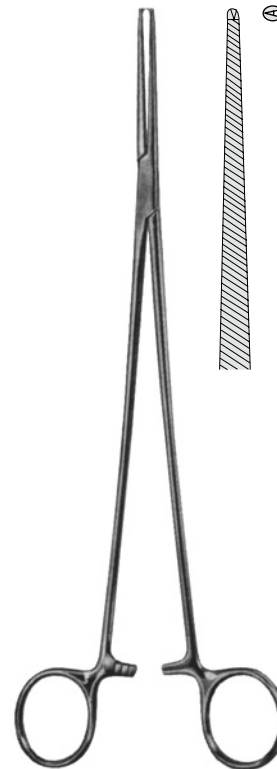
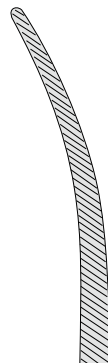

BENGOLEA
 15.0364 20 cm 1x2
 15.0366 26 cm 1x2

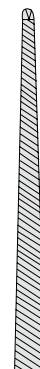

15.0365 20 cm 1x2
 15.0367 26 cm 1x2

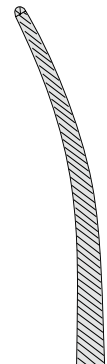



BRIDGE
15.0392 28 cm

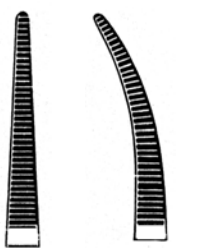

15.0393
28 cm

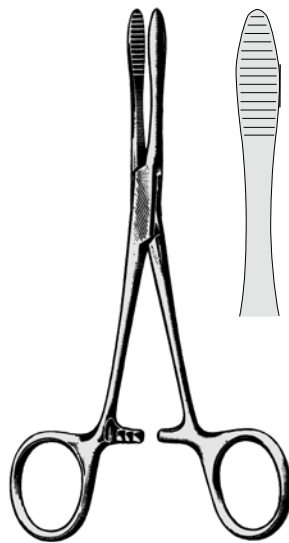

PEAN
15.0404 12,5 cm
15.0406 14,5 cm
15.0408 16 cm

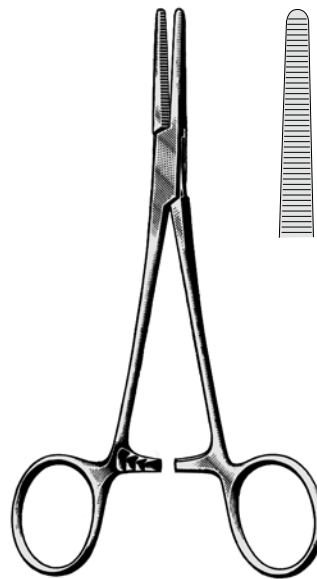

SPENCER-WELLS
15.0410 13 cm
15.0412 14 cm
15.0414 15 cm
15.0416 18 cm
15.0418 20 cm

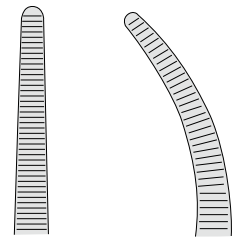

SPENCER-WELLS
15.0411 13 cm
15.0413 14 cm
15.0415 15 cm
15.0417 18 cm
15.0419 20 cm



ROCH-CARMALT
15.0430 16 cm
15.0432 20 cm

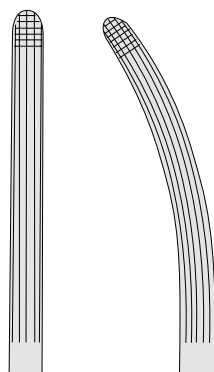

15.0431 16 cm
15.0433 20 cm

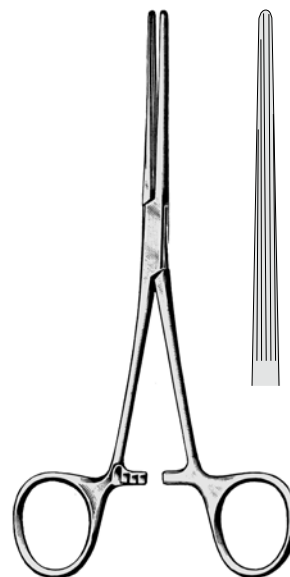

BAINBRIDGE
15.1320 15,5 cm
15.1322 18,0 cm

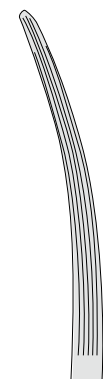

15.1321 15,5 cm
15.1323 18,0 cm

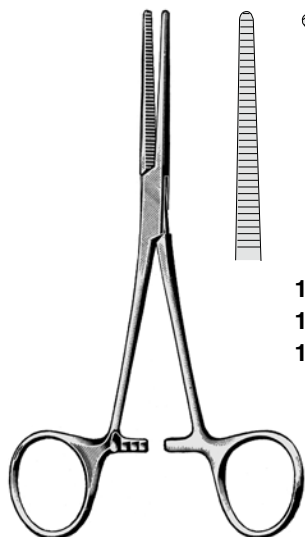

15.0451 13 cm
 15.0453 14 cm
 15.0455 16 cm

PEAN-FINO

15.0450 13 cm
 15.0452 14 cm
 15.0454 16 cm

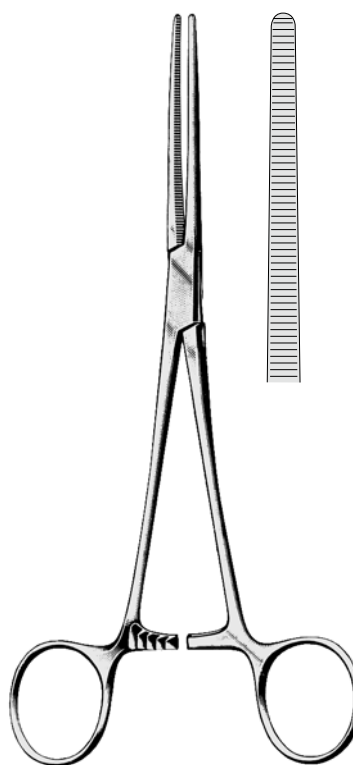

15.0459 13 cm
 15.0461 14 cm
 15.0463 16 cm
 15.0465 18 cm
 15.0467 20 cm
 15.0469 22 cm
 15.0471 24 cm
 15.0473 26 cm
 15.0477 30 cm

ROCHESTER-PEAN

15.0458 13 cm
 15.0460 14 cm
 15.0462 16 cm
 15.0464 18 cm
 15.0466 20 cm
 15.0468 22 cm
 15.0470 24 cm
 15.0472 26 cm
 15.0476 30 cm

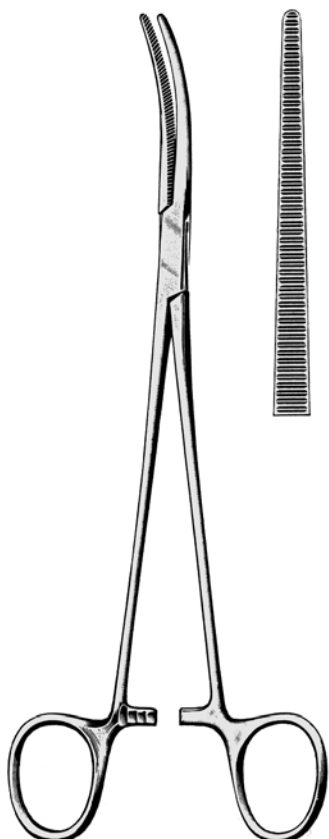

15.0481

ROBERTS

15.0480 22 cm

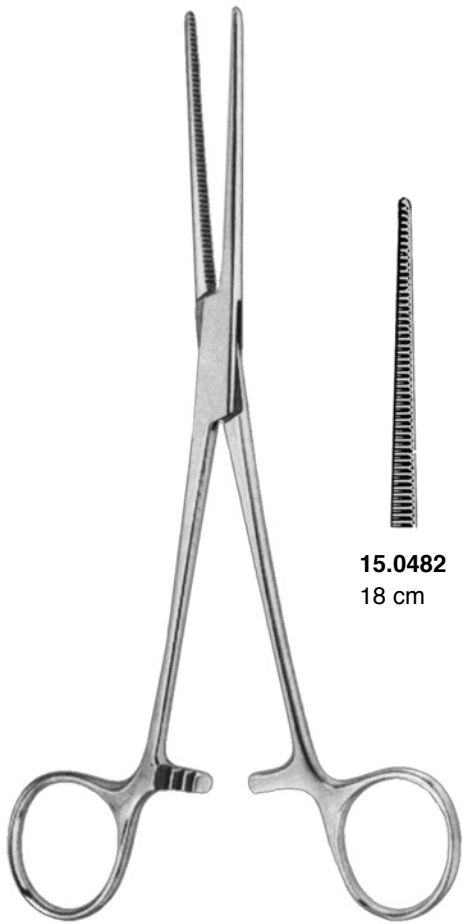

OLIVECRONA

15.0482
18 cm

15.0484
20 cm

15.0486
24 cm

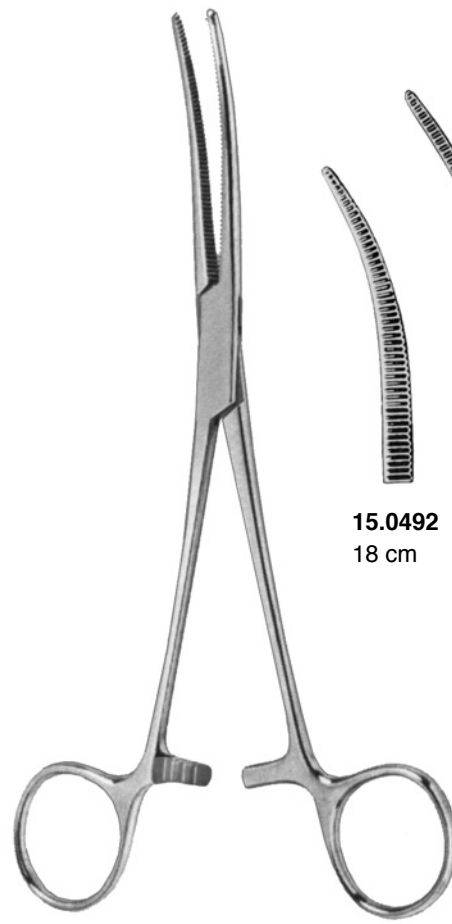

CRAFOORD

15.0492
18 cm

15.0493
20 cm

15.0494
24 cm



CRAFOORD-SELLORS
24 cm

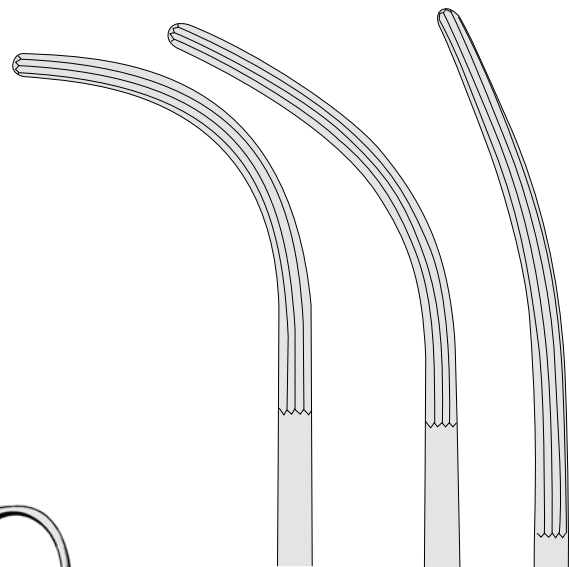

15.0495

15.0496

15.0497



ROCHESTER-OCHSNER

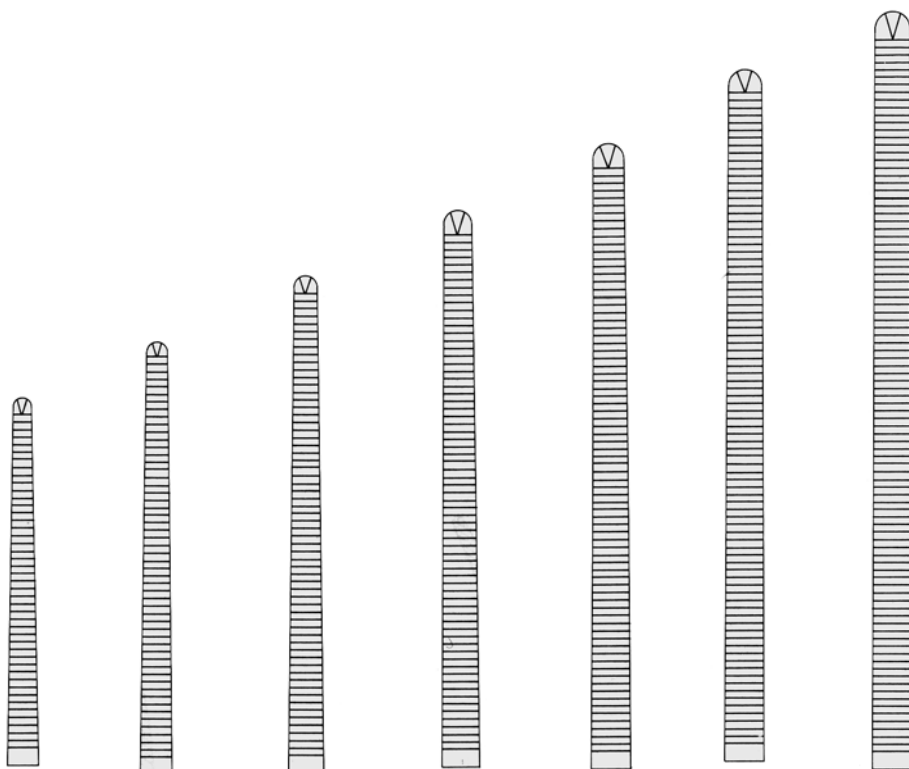

15.0620	15.0622	15.0624	15.0626	15.0628	15.0630	15.0632
16 cm	18 cm	20 cm	22 cm	24 cm	26 cm	30 cm
1x2	1x2	1x2	1x2	1x2	1x2	1x2

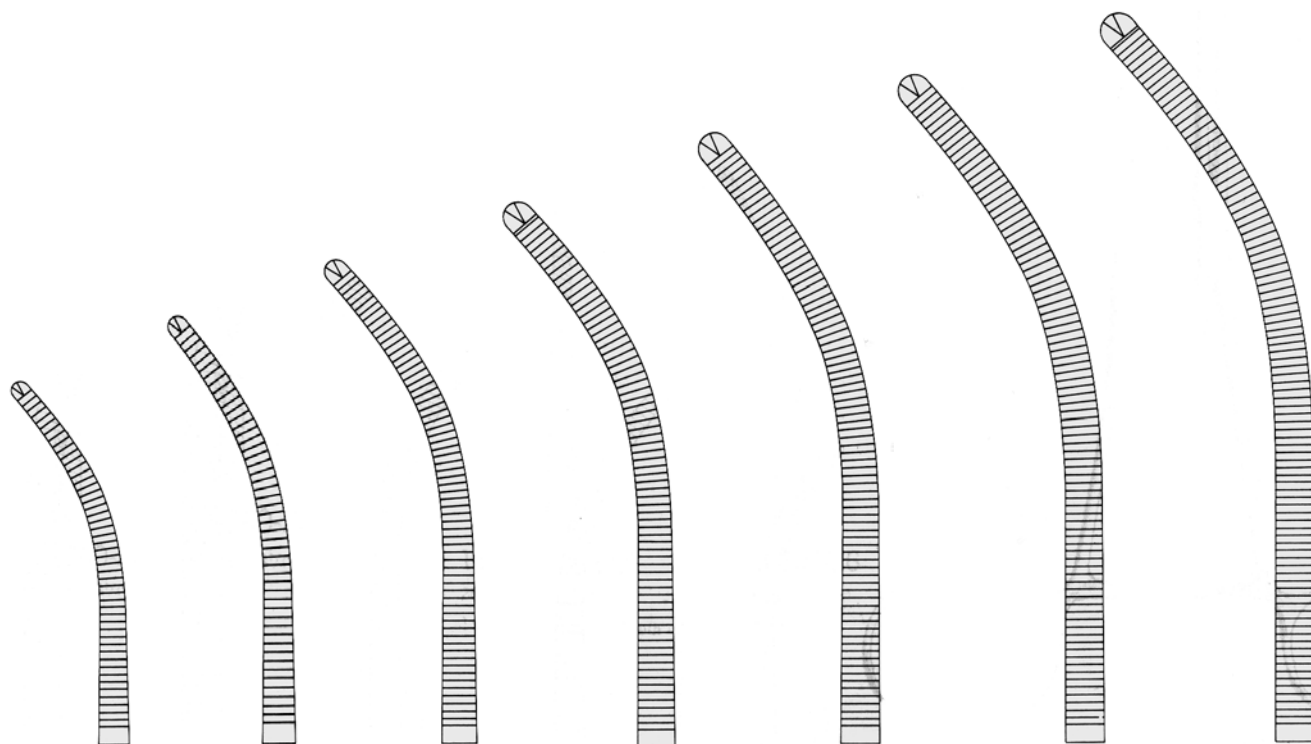

15.0621	15.0623	15.0625	15.0627	15.0629	15.0631	15.0633
16 cm	18 cm	20 cm	22 cm	24 cm	26 cm	30 cm
1x2	1x2	1x2	1x2	1x2	1x2	1x2

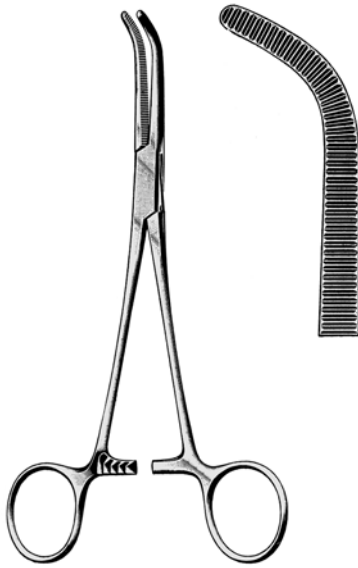

MIXTER-O'SHAUGHNESSY

15.0701 15 cm
 15.0703 19 cm

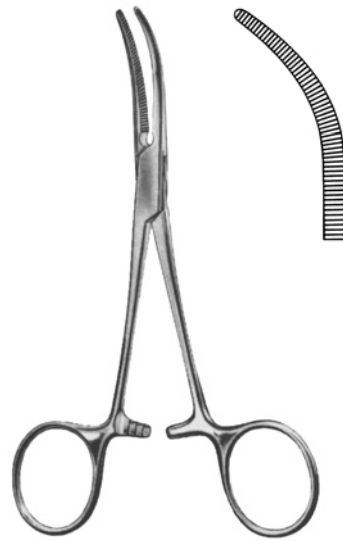

OVERHOLT-BABY

15.0720 14 cm

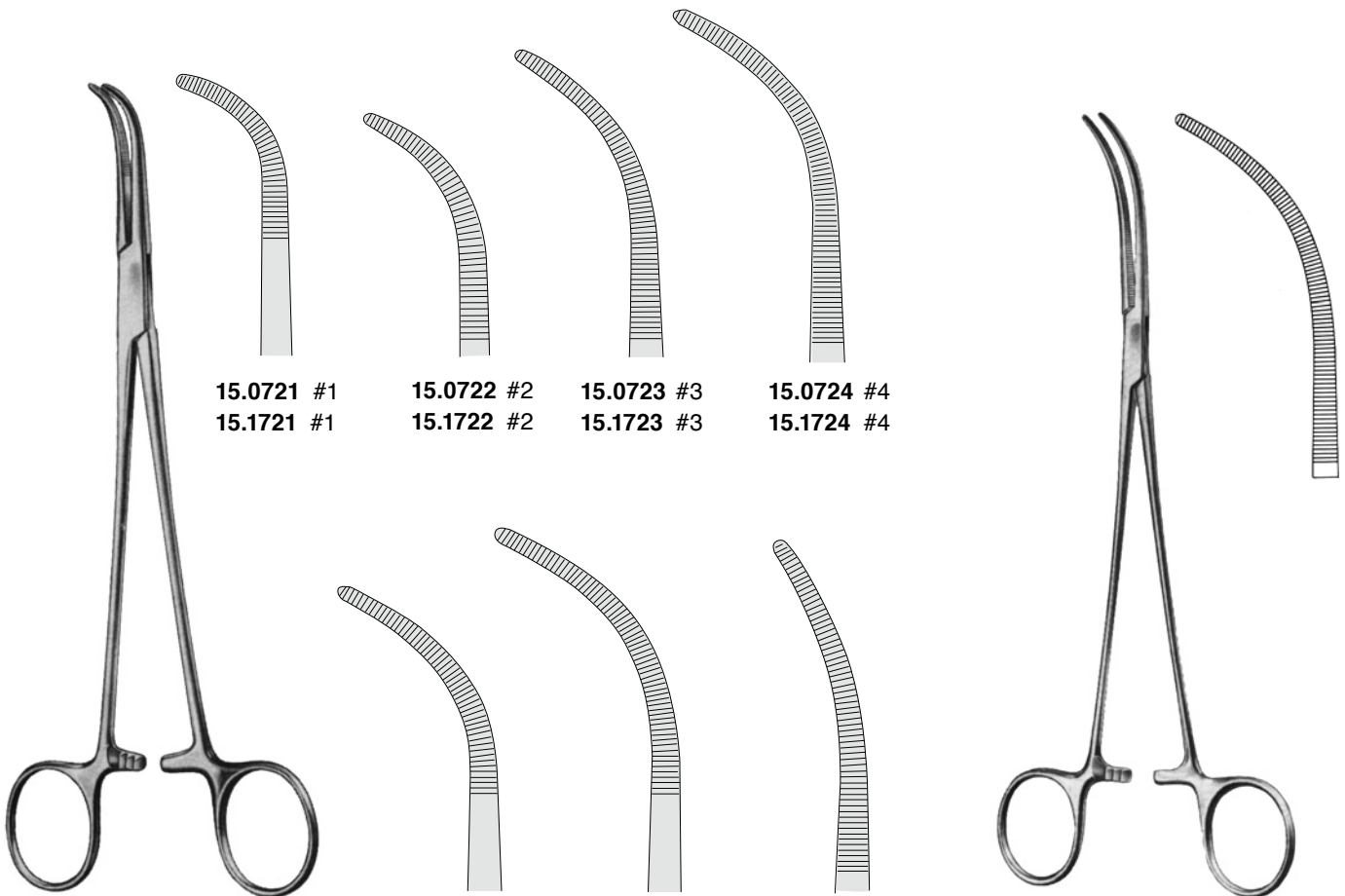

15.0721 #1
 15.1721 #1

15.0722 #2
 15.1722 #2

15.0723 #3
 15.1723 #3

15.0724 #4
 15.1724 #4

**OVERHOLT-
 GEISSENDOERFER**

15.0721-15.0727 21 cm
 15.1721-15.1727 27 cm

15.0725 #5
 15.1725 #5

15.0726 #6
 15.1726 #6

15.0727 #7
 15.1727 #7

OVERHOLT-MIXTER

15.0729 21 cm

PRÄPARIER- UND LIGATURKLEMMEN
DISSECTING AND LIGATURE FORCEPS
PINCES A DISSEQUER ET A LIGATURES
PINZAS PARA DISECCION Y LIGATURAS
PINZE PER PREPARAZIONI E LEGATURE

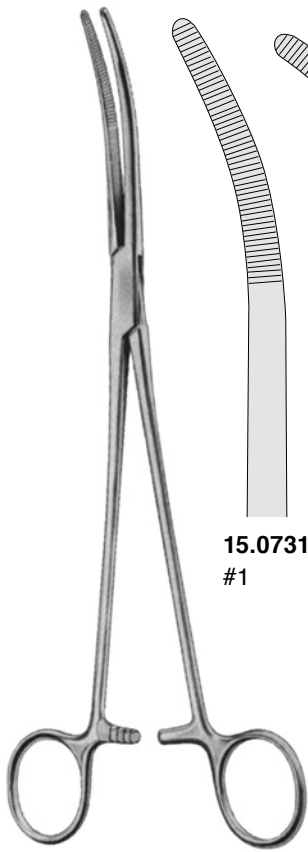

RUMEL
23 cm

15.0731
#1

15.0732
#2

15.0733
#3

15.0734
#4

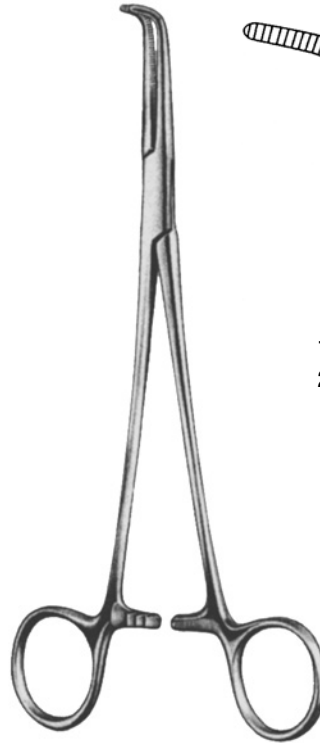

KANTROWITZ

15.0741
20 cm

15.0743
24 cm

15.0745
28 cm

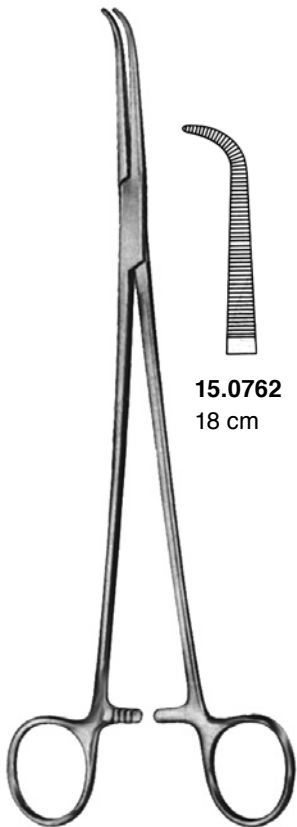

GEMINI-MINI

15.0762
18 cm

15.0764
22 cm

15.0765
25 cm

15.0766
28 cm

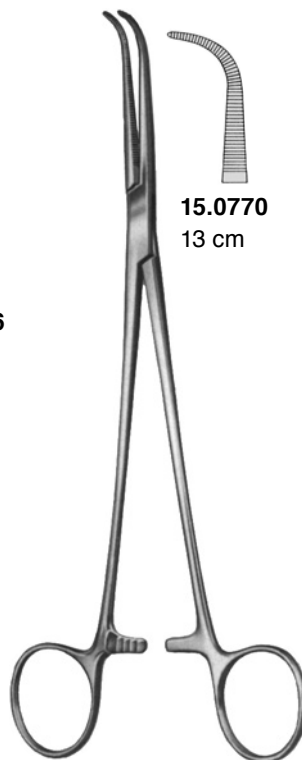

GEMINI

15.0770
13 cm

15.0771
16 cm

15.0772
18 cm

15.0773
20 cm

15.0774
23 cm

15.0775
25 cm

15.0776
28 cm

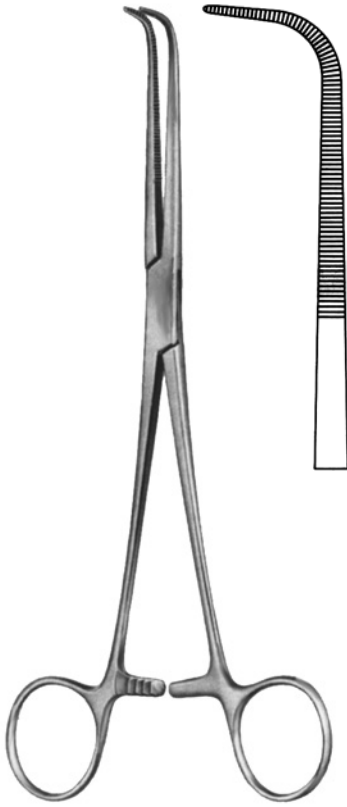

WIKSTROEM
 15.0780 21 cm
 15.0782 24 cm

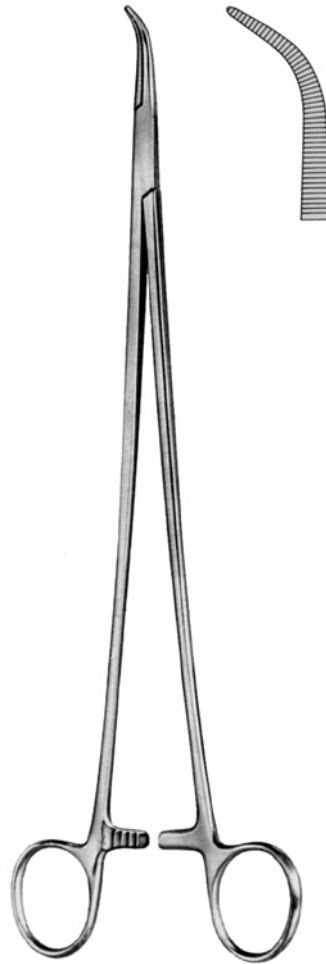

LAWRENCE
 15.0784 28 cm



MEEKER
 15.0786 28 cm



MIXTER-BABY
 15.0801 14,5 cm

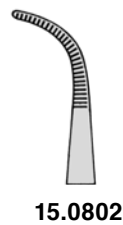

15.0802



MIXTER-BABY
 15.0803 18 cm



MIXTER
15.0807 22 cm



MIXTER
15.0809 23 cm

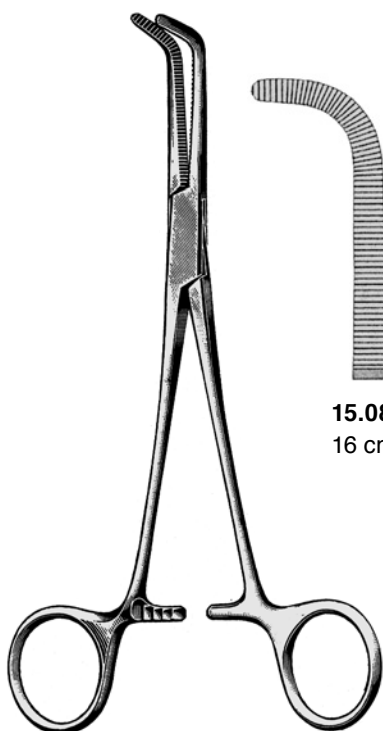

MIXTER

15.0811
16 cm

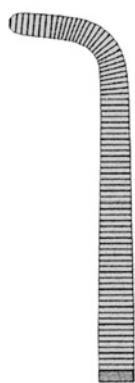

15.0813
19 cm

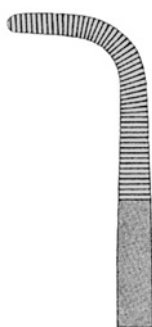

15.0817
23 cm



MIXTER

15.0831
22 cm

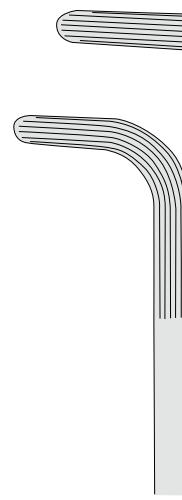
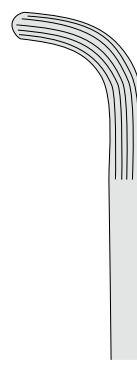

15.0833
25 cm



15.0835
28 cm

Arterien- und Präparierklemmen
Hemostatic- and Dissecting Forceps
Pincers hémostatiques et à disséquer
Pinzas hemostáticas y para preparación
Pinze emostatiche e per preparazione



DEBAKEY-COLLIER
15.0269
36 cm

Arterien- und Präparierklemmen / Hemostatic- and Dissecting Forceps /
Pincas hémostatiques et à disséquer / Pinzas hemostáticas y para preparación /
Pinze emostatiche e per preparazione



ROCHESTER-PEAN
15.0478
36 cm



ROCHESTER-PEAN
15.0479
36 cm

Arterien- und Präparierklemmen / Hemostatic- and Dissecting Forceps /
Pinces hémostatiques et à disséquer / Pinzas hemostáticas y para preparación /
Pinze emostatiche e per preparazione



CRAFOORD-SELLORS
15.0499
36 cm



SAROT
15.0503
36 cm

Arterien- und Präparierklemmen / Hemostatic- and Dissecting Forceps /
Pincés hémostatiques et à disséquer / Pinzas hemostáticas y para preparación /
Pinze emostatiche e per preparazione



ROCH.-OCHSNER
15.0634
36 cm



ROCH.-OCHSNER
15.0635
36 cm

Arterien- und Präparierklemmen / Hemostatic- and Dissecting Forceps /
Pincas hémostatiques et à disséquer / Pinzas hemostáticas y para preparación /
Pinze emostatiche e per preparazione



GEMINI
15.0778
36 cm



GUYON
15.1936
36 cm

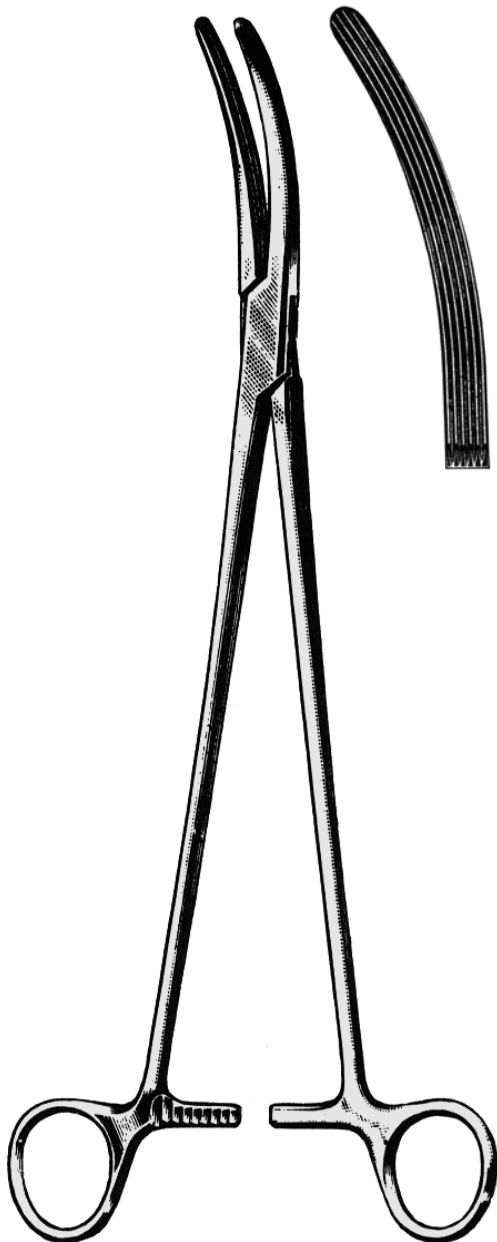

HARRINGTON
40.0705
36 cm



ALLIS
48.0019
36 cm
5 x 6

Arterien- und Präparierklemmen / Hemostatic- and Dissecting Forceps /
Pinces hémostatiques et à disséquer / Pinzas hemostáticas y para preparación /
Pinze emostatiche e per preparazione

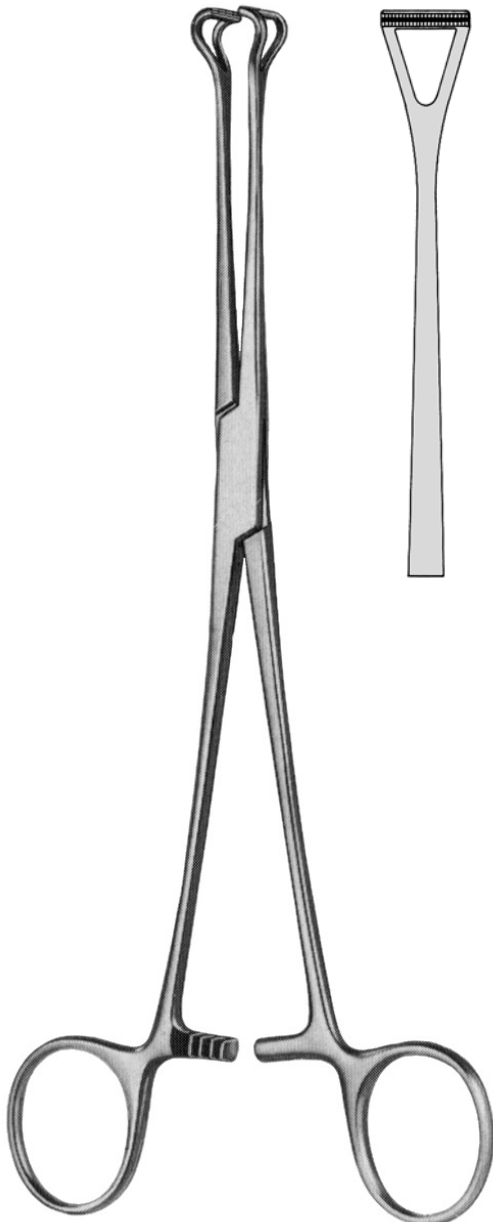

BABCOCK
48.0069
36 cm

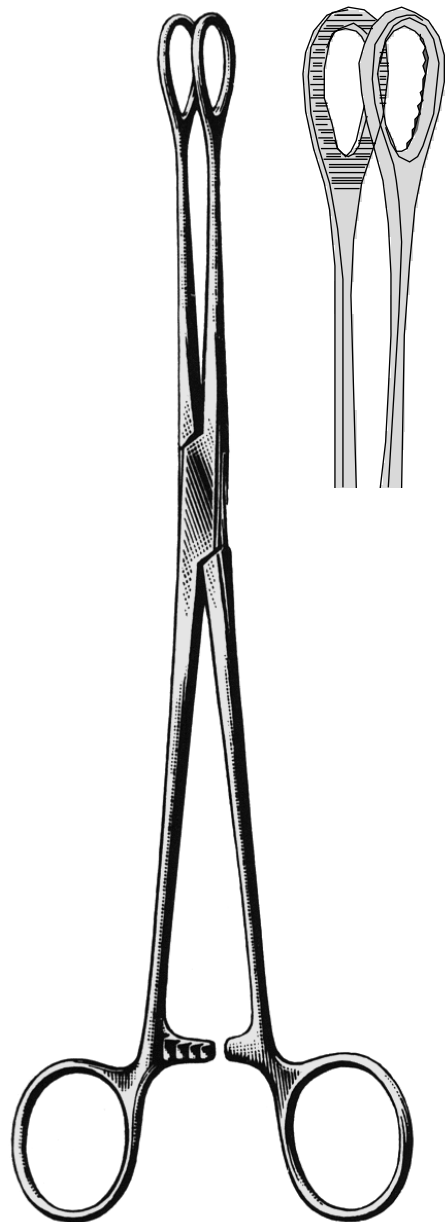

FOERSTER
16.0436
36 cm
gerieft
serrated
strié
estriada
con striatura

