

ARTERIENKLEMMEN, PRÄPARIERKLEMMEN
HEMOSTATIC AND DISSECTING FORCEPS
PINCES HEMOSTATIQUES ET A PREPARATION
PINZAS HEMOSTATICAS Y PARA PREPARACIONES
PINZE EMOSTATICE E PER PREPARAZIONE

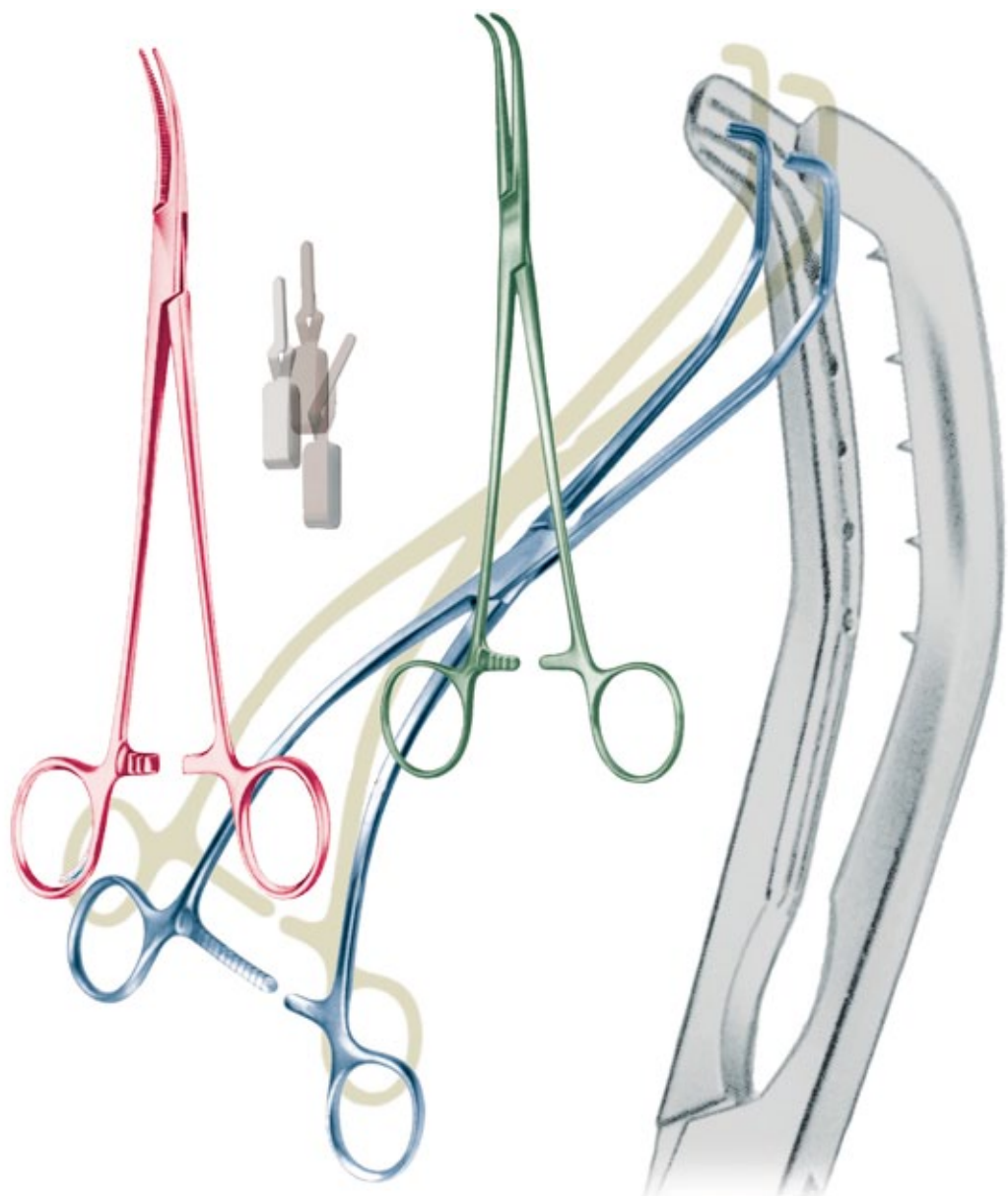













“ACLAND” MIKRO-GEFÄSSCLIPS
 “ACLAND” MICRO VASCULAR CLIPS
 “ACLAND” MICRO CLIPS VASCULAIRES
 “ACLAND” MICRO CLIPS VASCULARES
 “ACLAND” MICRO CLIPS VASCOLARI

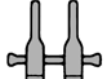

Anlegepinzette für Mikro-Gefäßklemmen 40.9286 bis 40.9419
 Applying forceps for micro vascular clamps 40.9286 to 40.9419
 Pince à poser les micro-clamps vasculaires 40.9286 à 40.9419
 Pinzas para aplicar micro-clamps vasculares 40.9286 a 40.9419
 Pinze per applicazione per clips vascolari 40.9286-40.9419

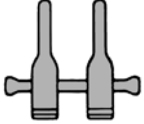
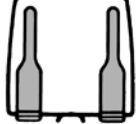
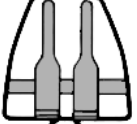
40.9071
 mit Sperre
 with ratchet
 avec verrou
 con cierre
 con fermo

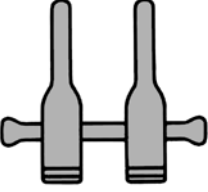
40.9072
 ohne Sperre
 without ratchet
 sans verrou
 sin cierre
 senza fermo

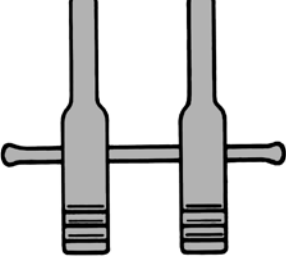
Gefäßgröße Vessel size Grandeur des vaisseaux Tamaño de vaso Taglia del vaso	Einzelklemmen (Paar) Single clamps (pair) Clamps individuels (paire) Clamps individuales (par) Clips solo (paio)	Approximatoren ohne Rahmen, beweglich Approximators without frame, movable Approximateurs, sans cadre, mobiles Aproximadores sin cuadro, móviles Approssimatori doppi spostabili	Doppelklemmen mit Rahmen Double clamps with frame Clamps doubles avec cadre Clamps dobles con cuadro Approssimatori doppi con telaio	Approximatoren mit Rahmen, beweglich Approximators with frame, movable Approximateurs, avec cadre, mobiles Aproximadores con cuadro, móviles Approssimatori doppi con telaio spostabile
0,4-1,0 mm	 schwarz black noir negro nero 40.9396V 40.9462V 40.9397A 40.9461A	 schwarz black noir negro nero 40.9414V 40.9480V 40.9415A 40.9479A	 40.9402V 40.9403A	 schwarz black noir negro nero 40.9408V 40.9474V 40.9409A 40.9473A
0,6-1,5 mm	 40.9398V 40.9464V 40.9399A 40.9463A	 40.9416V 40.9482V 40.9417A 40.9481A	 40.9404V 40.9405A	 40.9410V 40.9476V 40.9411A 40.9475A
1,0-2,25 mm	 40.9400V 40.9466V 40.9401A 40.9465A	 40.9418V 40.9484V 40.9419A 40.9483A	 40.9406V 40.9407A	 40.9412V 40.9478V 40.9413A 40.9477A
1,5-3,5 mm	 40.9325V 40.9329V 40.9325A 40.9329A	 40.9326V 40.9330V		
2,0-5,0 mm	 40.9286V 40.9327V 40.9286A 40.9327A	 40.9287V 40.9328V		V= für Venen for veins pour des veines para venas per vene A= für Arterien for arteries pour des artères para arterias per arterie



BIEMER-MÜLLER

		Maulöffnung jaw opening Ouverture des mors Apertura de boca apertura morso	Maullänge Jaw length Longueur des mors Longitud de boca lunghezza morso	Schließdruck Closing pressure pression d'occlusion presión de oclusión pressione oclusiva
	40.6411	5 mm	9 mm	30 - 40 gr.
	40.6412	5 mm	9 mm	30 - 40 gr.
	40.6413	5 mm	9 mm	30 - 40 gr.
	40.6414	5 mm	9 mm	30 - 40 gr.
	40.6415	4 mm	6 mm	30 - 40 gr.



BIEMER

40.6435

Nerv-Approximator komplett (mit Schlüssel 40.6476) Zur sicheren Adaption bei Nervanastomosen. Nadeln mit Schlüssel 40.6476 auswechselbar. Der Abstand zwischen den Nadeln ist variabel und wird mit Schlüssel 40.6476 fixiert

Approximator for safe adaptation of nerve anastomoses with key No. 40.6476. Needles are exchangeable with key 40.6476. The distance between the needles is variable and fixed with key No. 40.6476.

Approximateur pour nerfs (avec clef No. 40.6476), bien adapté pour anastomoses des nerfs. Les aiguilles peuvent être échangées avec la clef. La distance entre les aiguilles est variable et se fixe avec clef No. 40.6476

Approximador para nervios (con llave 40.6476), para asegurar la adaptación de anastomosis de nervios. Las agujas se pueden cambiar con la llave.

Approssimatore per nervi (con chiave 40.6476), per una precisa regolazione nella anastomosi dei nervi. Aghi scambiabili par chiave 40.6476. Distanza variabile degli aghi con chiave 40.6476.



40.6476

Schlüssel allein

Key only

Clef seule

Llave suelta

chiave solo

40.6436

1 Paar Ersatznadeln

1 pair of spare needles

1 paire d'aiguilles de rechange

1 par de agujas de repuesto

1 paio aghi di ricambio



BIEMER

40.6475

Approximator mit Schlüssel 40.6476, für Mikro-Gefäßanastomosen im tieferen Bereich; Schließdruck und Abstand zwischen den Clips mit Schlüssel 40.6476 einstellbar

Approximator with key 40.6476, for micro vessel anastomosis in the deeper range. The pressure and distance between the clips are variable and fixed with key 40.6476

Approximateur avec clef 40.6476, pour anastomoses micro-vasculaires en profondeur. Pression et distance entre les clips sont variable et ajustable avec la clef 40.6476.

Aproximador con llave 40.6476, para anastomosis micro-vascular en la profundidad. Presión de oclusión y la distancia entre los clips son variable y se fijan con la llave 40.6476

Approssimatore con chiave 40.6476 per anastomosi profondi. La pressione di occlusione viene regolata con chiave.

40.6474

Approximator alleine

Approximator only

Approximateur seul

Aproximador suelto

Approssimatore solo

MIKRO-GEFÄSSCLIPS FÜR TEMPORÄREN VERSCHLUSS
MICRO VESSEL CLIPS FOR TEMPORARY OCCLUSION
MICRO CLIPS VASCULAIRES POUR OCCLUSION TEMPORAIRE
MICRO CLIPS VASCULARES PARA OCLUSION TEMPORAL
MICRO CLIPS VASCOLARI PER OCCLUSIONE TEMPORANEA

Maul schräg gerieft
 Jaws with oblique serrations
 Mors striés en oblique
 Boca estriada al obliquo
 Morsi a scanalatura obliqua

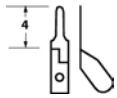
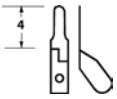
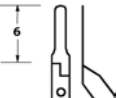
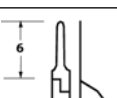

MEHDORN

		Maullänge Jaw length Longueur des mors Longitud de boca lunghezza morso	Schließdruck Closing pressure pression d'occlusion presión de oclusión pressione occlusiva
	40.6452	4 x 1,0 mm	10 - 15 gr.
	40.6454	4 x 1,4 mm	15 - 20 gr.
	40.6456	6 x 1,0 mm	10 - 15 gr.
	40.6458	6 x 1,4 mm	15 - 20 gr.



MEHDORN

40.6478 14,5 cm

Anlegepinzette für MEHDORN Clips 40.6452 - 40.6458

Applying forceps for MEHDORN Clips 40.6452 - 40.6458

Pince pour poser clips MEHDORN 40.6452 - 40.6458

Pinza para aplicar clips MEHDORN 40.6452 - 40.6458



Applicatore per clips MEHDORN 40.6452 - 40.6458

MIKRO-GEFÄSSCLIPS FÜR TEMPORÄREN VERSCHLUSS
 MICRO VESSEL CLIPS FOR TEMPORARY OCCLUSION
 MICRO CLIPS VASCULAIRES POUR OCCLUSION TEMPORAIRE
 MICRO CLIPS VASCULARES PARA OCCLUSION TEMPORAL
 MICRO CLIPS VASCOLARI PER OCCLUSIONE TEMPORANEA

Maul schräg gerieft
 Jaws with oblique serrations
 Mors striés en oblique
 Boca estriada al obliquo
 Morsi a scanalatura obliqua

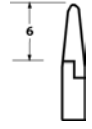

BIEMER

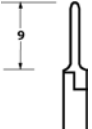
		Maulöffnung jaw opening Ouverture des mors Apertura de boca apertura morso	Maullänge Jaw length Longueur des mors Longitud de boca lunghezza morso	Schließdruck Closing pressure pression d'occlusion presión de oclusión pressione occlusiva
	40.6460	4,0 mm	6,0 mm	30 - 40 gr.
	40.6461	5,0 mm	9,0 mm	30 - 40 gr.
	40.6462	5,0 mm	9,0 mm	20 - 25 gr.



BIEMER

40.6468 14,5 cm

Anlegepinzette für BIEMER Clips 40.6460 - 40.6462 ohne Schloß
 Applying forceps for BIEMER Clips 40.6460 - 40.6462 without lock
 Pince pour poser clips BIEMER Clips 40.6460 - 40.6462 sans arrêt
 Pinza para aplicar clips BIEMER Clips 40.6460 - 40.6462 sin cerradura
 Applicatore per clips BIEMER Clips 40.6460 - 40.6462 senza cremagliera



BIEMER

40.6469 14,5 cm

Anlegepinzette für BIEMER Clips 40.6460 - 40.6462 mit Schloß
 Applying forceps for BIEMER Clips 40.6460 - 40.6462 with lock
 Pince pour poser clips BIEMER Clips 40.6460 - 40.6462 avec arrêt
 Pinza para aplicar clips BIEMER Clips 40.6460 - 40.6462 con cerradura
 Applicatore per clips BIEMER Clips 40.6460 - 40.6462 con cremagliera

MIKRO-GEFÄSSCLIPS FÜR TEMPORÄREN VERSCHLUSS
MICRO VESSEL CLIPS FOR TEMPORARY OCCLUSION
MICRO CLIPS VASCULAIRES POUR OCCLUSION TEMPORAIRE
MICRO CLIPS VASCULARES PARA OCLUSION TEMPORAL
MICRO CLIPS VASCOLARI PER OCCLUSIONE TEMPORANEA

Maul mit atraumatischer Riefung
 Jaws with atraumatic serrations
 Mors avec striure atraumatique
 Boca estriada al atraumatica
 Morsi con scanalatura atraumatica



MÜLLER

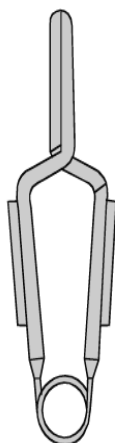

MÜLLER

40.6505

Fadenclip gerade gerieft
 Ligature-Clip serrated
 Clip à ligatures strié
 Clip para ligaduras estriada
 Clip-legature con scanalatura retta

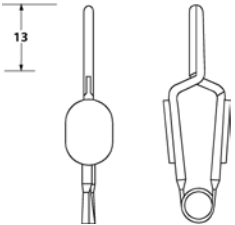
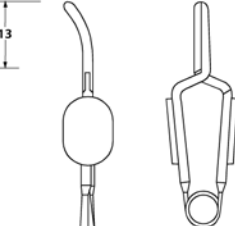
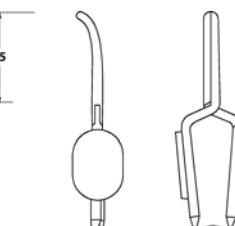
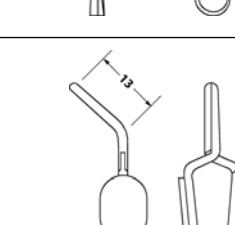
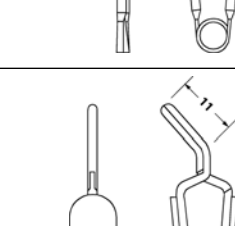
		Schließdruck Closing pressure pression d'occlusion presión de oclusión pressione occlusiva
	40.6510 40.6520	50 gr. 80 gr.
	40.6511 40.6521	50 gr. 80 gr.
	40.6512 40.6522	50 gr. 80 gr.
	40.6513 40.6523	50 gr. 80 gr.
	40.6514 40.6524	50 gr. 80 gr.

TITANIUM

Anlegezangen
 applying forceps
 pinces à appliquer
 pinzas para poner
 pinze per applicare

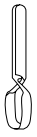

MICRO-CLIP
15.0001 15.0001T
 10 x 2 mm
 60 gr.



MICRO-CLIP
15.0002 15.0002T
 8 x 2 mm
 85 gr.



MICRO-CLIP
15.0003 15.0003T
 6 x 1 mm
 100 gr.



MICRO-CLIP
15.0004 15.0004T
 4 x 0,75 mm
 125 gr.



MICRO-CLIP
15.0005
 6 x 1 mm
 45°, 70 gr.



MICRO-CLIP
15.0006
 6 x 1 mm
 70 gr.



15.0008 14 cm



MINI-SERREFINE
15.0060 28 mm



MINI-SERREFINE
15.0061 28 mm

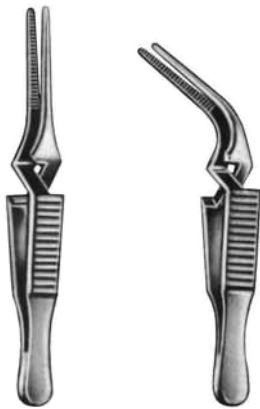

DIETRICH



A



B



C



D

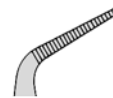

E

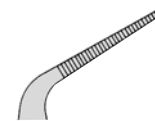

F

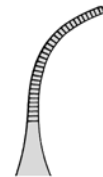

G

Artikel Item	Fig.	Gesamtlänge Overall length Longeur complet largo total Lunghezza totale	Maullänge Jaw length longeur de mors largo de boca Lunghezza del morso	Gewicht Weight Poids Peso Peso	Schliesdruck Closing pressure Pression d'Occlusion Presión de cierre Pressione occlusiva
41.0030	A	50 mm	8 mm	3 g	80
41.0031	D	43 mm	8 mm	3 g	80
41.0032	B	53 mm	12 mm	3 g	80
41.0033	E	45 mm	12 mm	3 g	80
41.0034	C	60 mm	20 mm	3 g	80
41.0035	F	50 mm	20 mm	3 g	80
41.0037	G	54 mm	20 mm	3 g	80

**FEINE GEFÄSSCLIPS
DELICATE VESSEL CLIPS
CLIPS VASCULAIRES DELICATS
CLIPS VASCULARES DELICADO
CLIPS VASCOLARI DELICATO**



**DEBAKEY-
MICRO**

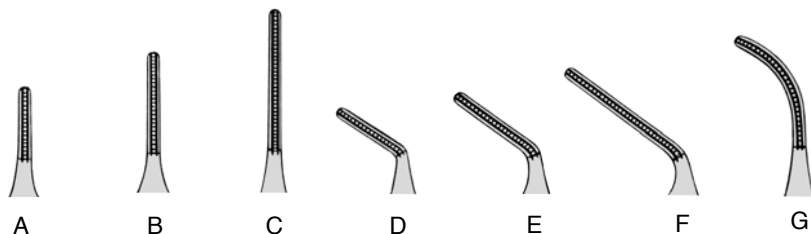

Artikel Item	Fig.	Gesamtlänge Overall length Longeur complet largo total Lunghezza totale	Maußlänge Jaw length longeur de mors largo de boca Lunghezza del morso	Gewicht Weight Poids Peso Peso	Schliesdruck Closing pressure Pression d'Occlusion Presión de cierre Pressione occlusiva
41.0090	A	47 mm	10 mm	3 g	180
41.0091	D	44 mm	10 mm	3 g	180
41.0092	B	51 mm	14 mm	3 g	180
41.0093	E	46 mm	14 mm	3 g	180
41.0094	C	57 mm	20 mm	3 g	180
41.0095	F	49 mm	20 mm	3 g	180
41.0099	G	54 mm	20 mm	3 g	180

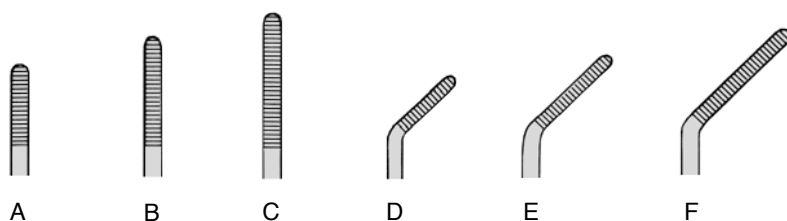

FEDERLEICHT • FEATHERLIGHT • POIDS PLUME • MUY LIGERO

Artikel Item	Fig.	Gesamtlänge Overall length Longeur complet largo total Lunghezza totale	Maußlänge Jaw length longeur de mors largo de boca Lunghezza del morso	Gewicht Weight Poids Peso Peso	Schliesdruck Closing pressure Pression d'Occlusion Presión de cierre Pressione occlusiva
41.0040	A	31 mm	10 mm	1 g	30
41.0041	B	35 mm	14 mm	1 g	30
41.0042	C	39 mm	18 mm	1 g	30
41.0043	D	30 mm	10 mm	1 g	30
41.0044	E	33 mm	14 mm	1 g	30
41.0045	E	36 mm	18 mm	1 g	30



WICKHAM

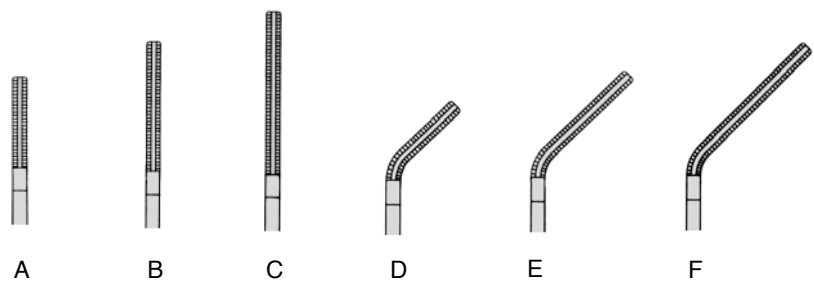

Artikel Item	Fig.	Gesamtlänge Overall length Longeur complet largo total Lunghezza total	Maullänge Jaw length longeur de mors largo de boca Lunghezza del morso	Gewicht Weight Poids Peso Peso	Schliessdruck Closing pressure Pression d'Occlusion Presión de cierre Pressione di chiusura
41.0080	A	49 mm	13 mm	3 g	150
41.0081	D	47 mm	13 mm	3 g	150
41.0082	B	54 mm	18 mm	3 g	150
41.0083	E	51 mm	18 mm	3 g	150
41.0084	C	61 mm	25 mm	3 g	150
41.0085	F	55 mm	25 mm	3 g	150

WICKHAM

41.0089 24 cm

Anlegezange / Applying forceps / Pince à pos /
Pinza de aplicación / Pinza per metti-rimouvi

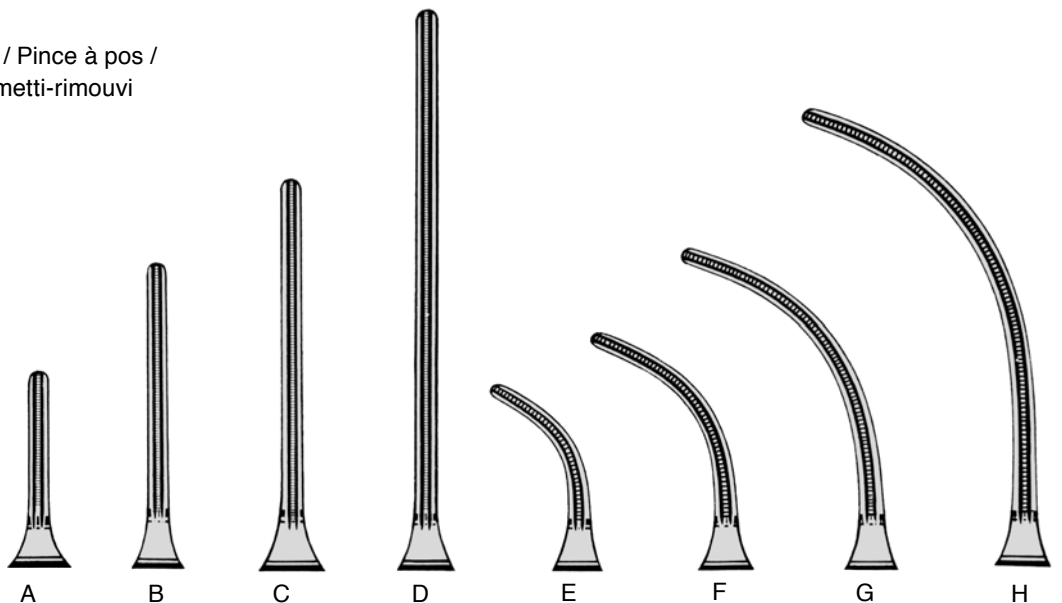
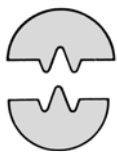

Artikel Item	Fig.	Gesamtlänge Overall length Longeur complet largo total Lunghezza total	Maullänge law length longeur de mors largo de boca Lunghezza del morso	Gewicht Weight Poids Peso Peso
41.0100	A	80 mm	20 mm	10 g
41.0101	E	75 mm	20 mm	10 g
41.0110	B	90 mm	30 mm	11 g
41.0111	F	85 mm	30 mm	11 g
41.0115	C	105 mm	45 mm	12 g
41.0116	G	95 mm	45 mm	12 g
41.0120	D	125 mm	68 mm	12 g
41.0121	H	115 mm	68 mm	12 g

DEBAKEY

TITANIUM

Identification:

A = ARTERIA

= closing force
 220 - 240 ± 10 g

V = VENA

= closing force
 110 - 130 ± 10 g

Anlege- u. Entfernungszange für
 TITAN Miniatur-Bulldog-Clips

Applying- and removing Forceps for
 TITAN Miniature Bulldog-Clips

Pinces pour poser et retirer les TITAN
 Clips Bulldog

Pinza para poner y quitar TITAN
 Miniature clips Bulldog

Pinza per mettere - rimuovere
 TITANIO Clips Bulldog



3,0 cm

41.0050A
 41.0050V



3,5 cm

41.0052A
 41.0052V



4,0 cm

41.0054A
 41.0054V



4,5 cm

41.0056A
 41.0056V



3,0 cm

41.0051A
 41.0051V



3,5 cm

41.0053A
 41.0053V



4,0 cm

41.0055A
 41.0055V



4,5 cm

41.0057A
 41.0057V



41.0069
 23 cm



3,0 cm

41.0061A
 41.0061V



3,5 cm

41.0063A
 41.0063V



4,0 cm

41.0065A
 41.0065V



4,5 cm

41.0067A
 41.0067V



BAYLEY
18 cm



15.0525 30°



15.0527 60°



15.0529 90°

sehr fein / very delicate / très fin / muy fina / molto fine

ARTERIENKLEMMEN, PRÄPARIERKLEMMEN
HEMOSTATIC- AND DISSECTING FORCEPS
PINCES HEMOSTATIQUES ET A PREPARATION
PINZAS HEMOSTATICAS Y PARA PREPARACIONES
PINZE EMOSTATICE E PER PREPARAZIONE



BABCOCK

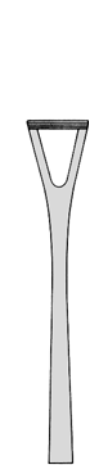

48.0062
16 cm

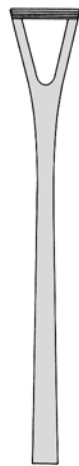

48.0064
18 cm



BABCOCK



48.0072
16 cm

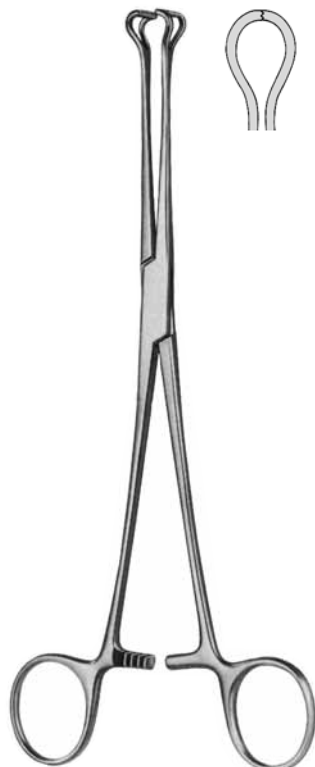

BABCOCK-DEBAKEY



48.0082
16 cm



48.0086
20 cm



COLLIN
48.0089
14 cm



DUVAL



48.0090
18 cm / 14 mm
48.0092
20 cm / 14 mm

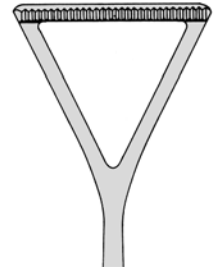

48.0094
20 cm / 25 mm
48.0098
23 cm / 25 mm



DUVAL



48.0099
20 cm / 15 mm

ARTERIENKLEMMEN, PRÄPARIERKLEMMEN
HEMOSTATIC- AND DISSECTING FORCEPS
PINCES HEMOSTATIQUES ET A PREPARATION
PINZAS HEMOSTATICAS Y PARA PREPARACIONES
PINZE EMOSTATICE E PER PREPARAZIONE

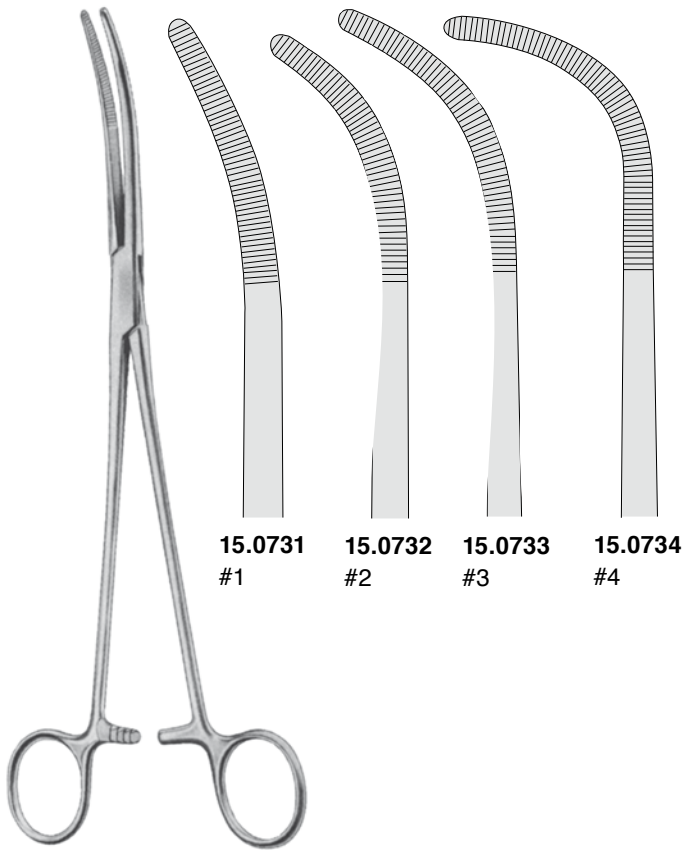

15.0731 #1
15.0732 #2
15.0733 #3
15.0734 #4

RUMEL
 23 cm



15.0741 20 cm
15.0743 24 cm
15.0745 28 cm

KANTROWITZ

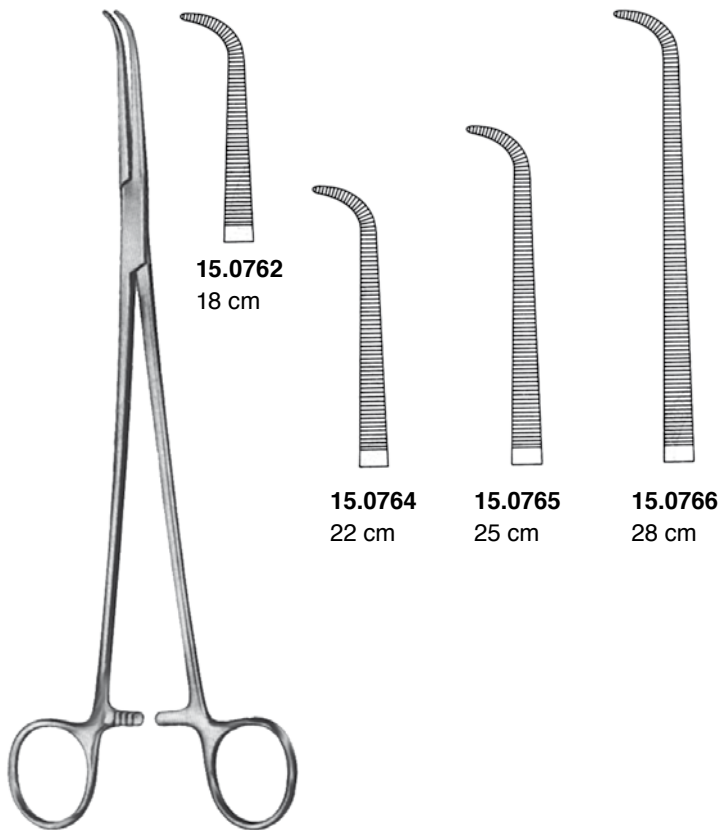

15.0762
 18 cm

15.0764
 22 cm

15.0765
 25 cm

15.0766
 28 cm

GEMINI-MINI

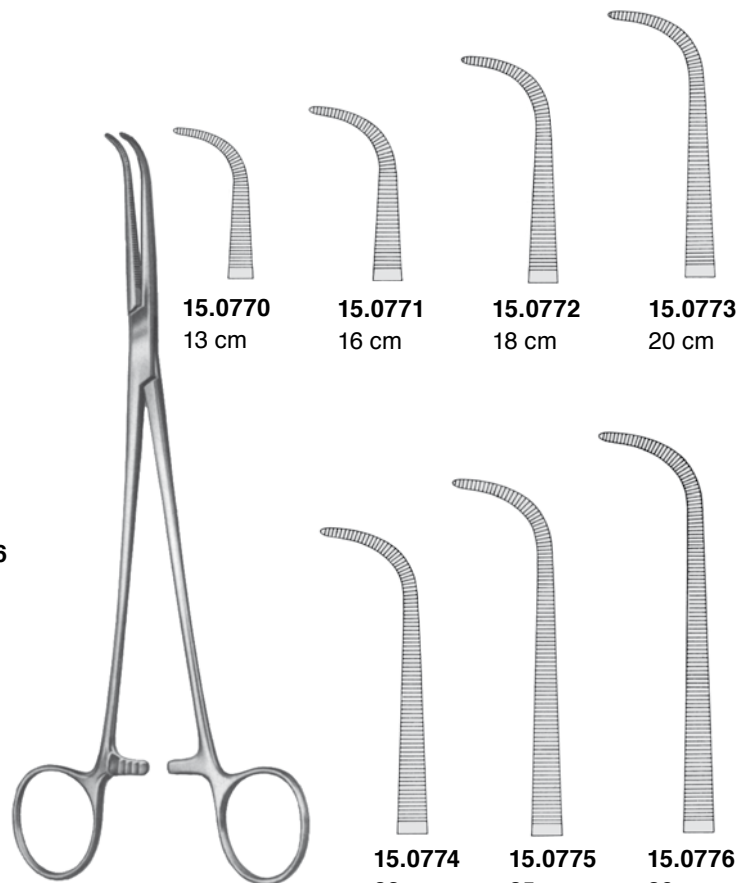

15.0770
 13 cm

15.0771
 16 cm

15.0772
 18 cm

15.0773
 20 cm

15.0774
 23 cm

15.0775
 25 cm

15.0776
 28 cm

GEMINI



WIKSTROEM
15.0780 21 cm
15.0782 24 cm



LAWRENCE
15.0784 28 cm



MEEKER
15.0786 28 cm



MIXTER-BABY
15.0801 14,5 cm

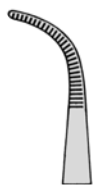

15.0802



MIXTER-BABY
15.0803 18 cm

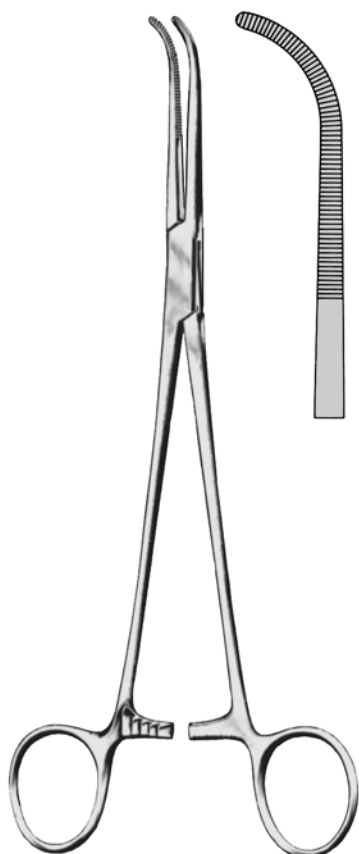

MIXTER
15.0807 22 cm



MIXTER
15.0809 23 cm



MIXTER



15.0811
16 cm

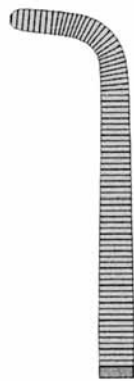

15.0813
19 cm



15.0817
23 cm



MIXTER

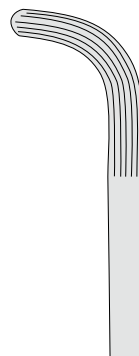

15.0831
22 cm

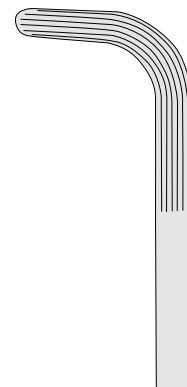

15.0833
25 cm

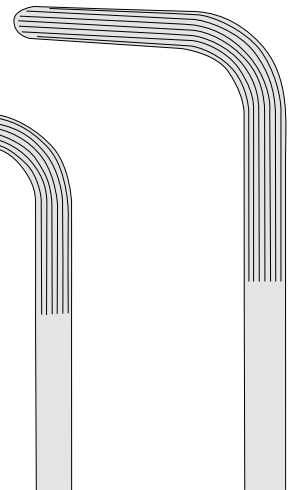

15.0835
28 cm

Arterien- und Präparierklemmen
Hemostatic- and Dissecting Forceps
Pincès hémostatiques et à disséquer
Pinzas hemostáticas y para preparación
Pinze emostatiche e per preparazione



DEBAKEY-COLLIER
15.0269
36 cm

Arterien- und Präparierklemmen / Hemostatic- and Dissecting Forceps /
Pincès hémostatiques et à disséquer / Pinzas hemostáticas y para preparación /
Pinze emostatiche e per preparazione



ROCHESTER-PEAN
15.0478
36 cm



ROCHESTER-PEAN
15.0479
36 cm

Arterien- und Präparierklemmen / Hemostatic- and Dissecting Forceps /
Pinces hémostatiques et à disséquer / Pinzas hemostáticas y para preparación /
Pinze emostatiche e per preparazione



CRAFOORD-SELLORS
15.0499
36 cm



SAROT
15.0503
36 cm

Arterien- und Präparierklemmen / Hemostatic- and Dissecting Forceps /
Pinces hémostatiques et à disséquer / Pinzas hemostáticas y para preparación /
Pinze emostatiche e per preparazione



ROCH.-OCHSNER
15.0634
36 cm



ROCH.-OCHSNER
15.0635
36 cm

Arterien- und Präparierklemmen / Hemostatic- and Dissecting Forceps /
Pinces hémostatiques et à disséquer / Pinzas hemostáticas y para preparación /
Pinze emostatiche e per preparazione



GEMINI
15.0778
36 cm

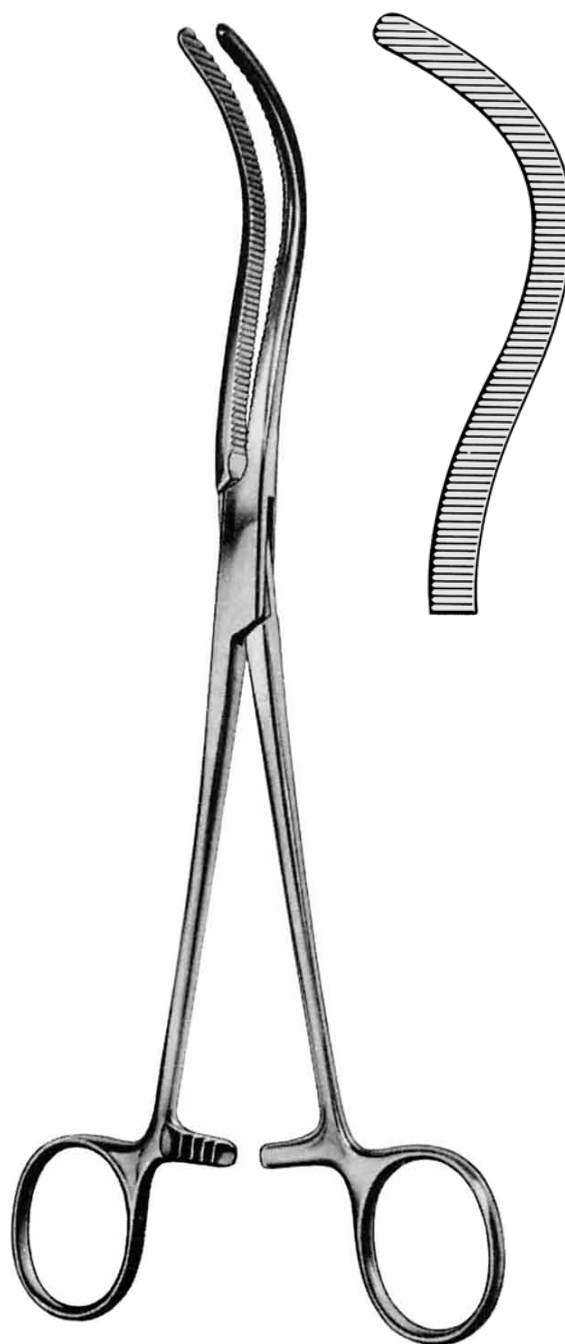

GUYON
15.1936
36 cm



HARRINGTON
40.0705
36 cm



ALLIS
48.0019
36 cm
5 x 6

**ARTERIENKLEMMEN, PRÄPARIERKLEMMEN
HEMOSTATIC- AND DISSECTING FORCEPS
PINCES HEMOSTATIQUES ET A PREPARATION
PINZAS HEMOSTATICAS Y PARA PREPARACIONES
PINZE EMOSTATICE E PER PREPARAZIONE**

Arterien- und Präparierklemmen / Hemostatic- and Dissecting Forceps /
Pincés hémostatiques et à disséquer / Pinzas hemostáticas y para preparación /
Pinze emostatiche e per preparazione

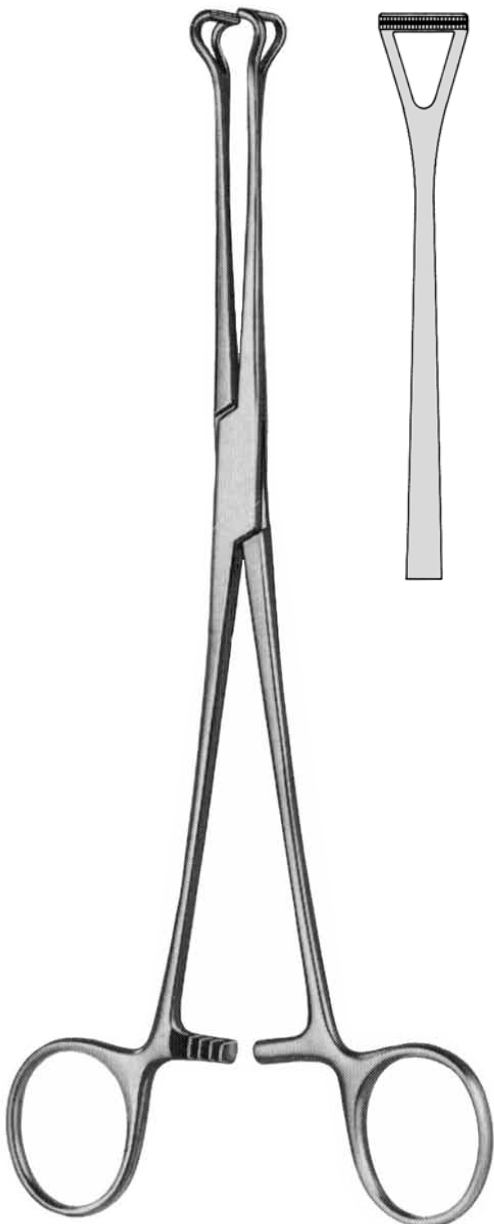

BABCOCK
48.0069
36 cm

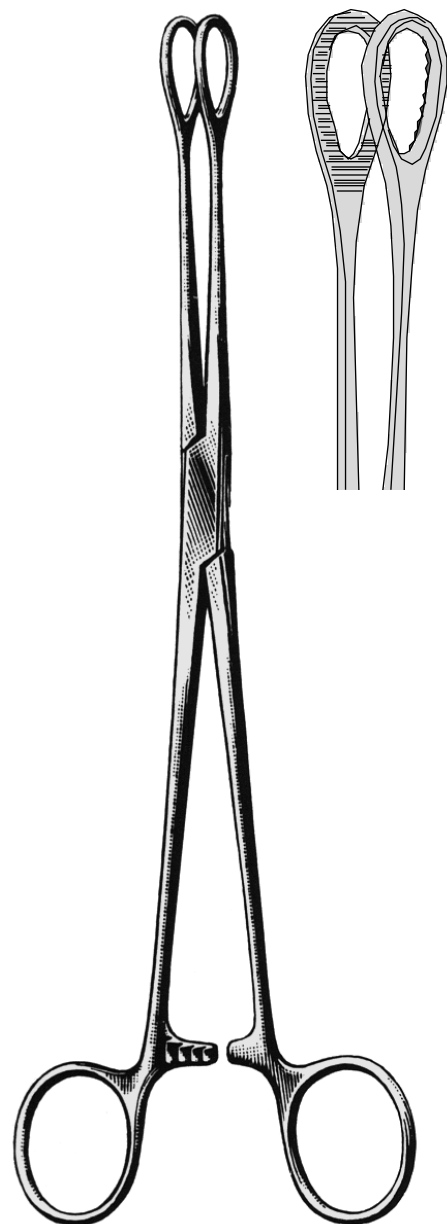

FOERSTER
16.0436
36 cm
gerieft
serrated
strié
estriada
con striatura

BRONCHUS- LIGATUR- UND LUNGENFASSZANGEN
 BRONCHUS, LIGATURE, AND LUNG GRASPING FORCEPS
 PINCES-DISSECTEURS, À LIGATURES, ET À POUMON
 PINZAS PARA BRONQUIOS, LIGADURAS Y PULMON
 PINZE PER DISSEZIONE, LIGATURE, BRONCHI E PULMONE



HARRINGTON
 40.0701
 30,5 cm

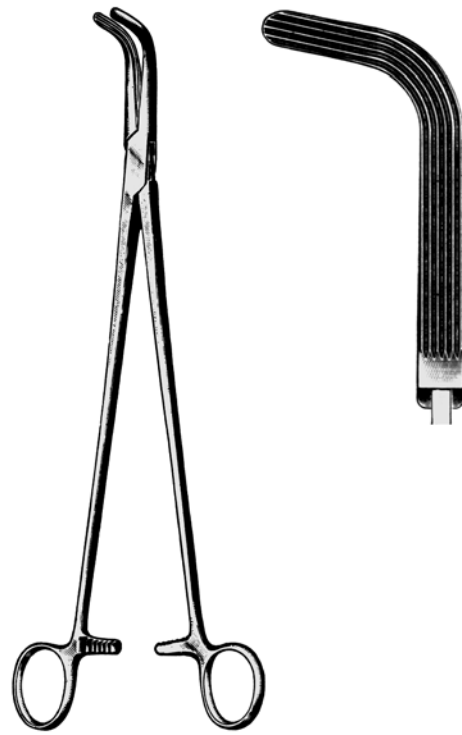

HARRINGTON
 40.0702
 29,5 cm



40.0713
 Zähne links
 teeth on left
 dents à gauche
 dientes a la izquierda
 denti sinistro

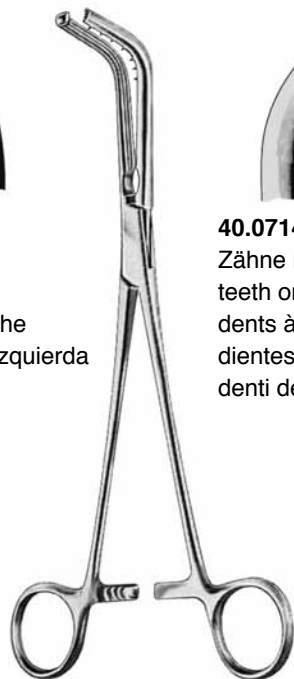

SAROT
 23 cm



40.0714
 Zähne rechts
 teeth on right
 dents à droite
 dientes a la derecha
 denti destro

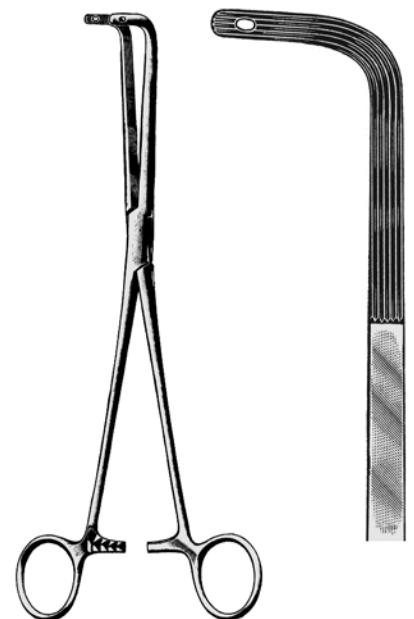

FINOCCHIETTO
 40.0720
 24 cm

BRONCHUS- LIGATUR- UND LUNGENFASSZANGEN
BRONCHUS, LIGATURE, AND LUNG GRASPING FORCEPS
PINCES DISSECTEURS, À LIGATURES, ET À POUMON
PINZAS PARA BRONQUIOS, LIGADURAS Y PULMON
PINZE PER DISSEZIONE, LIGATURE, BRONCHI E PULMONE



PRICE-THOMAS
22 cm

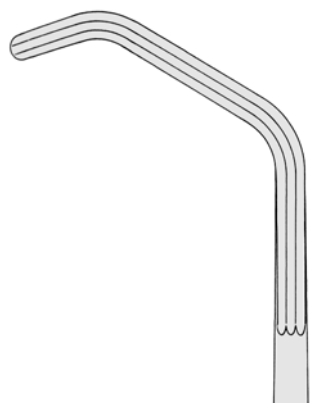

40.0730



PRICE-THOMAS
22 cm

40.0731
Zähne links
teeth on left
dents à gauche
dientes a la izquierda
denti sinistro



40.0732
Zähne rechts
teeth on right
dents à droite
dientes a la derecha
denti destro



BRONCHUS
23 cm



40.0740
60 mm



40.0742
80 mm

BRONCHUS- LIGATUR- UND LUNGENFASSZANGEN
BRONCHUS, LIGATURE, AND LUNG GRASPING FORCEPS
PINCES DISSECTEURS, À LIGATURES, ET À POUMON
PINZAS PARA BRONQUIOS, LIGADURAS Y PULMON
PINZE PER DISSEZIONE, LIGATURE, BRONCHI E PULMONE

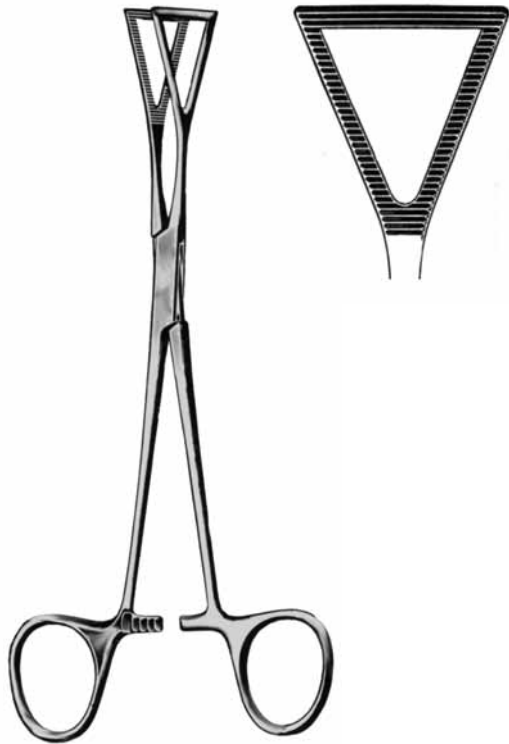

LOVELACE
40.0750
20 cm



LOVELACE
40.0751
20 cm



SEMB

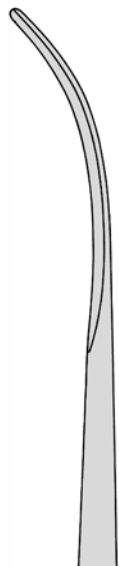

40.0761
24 cm #1

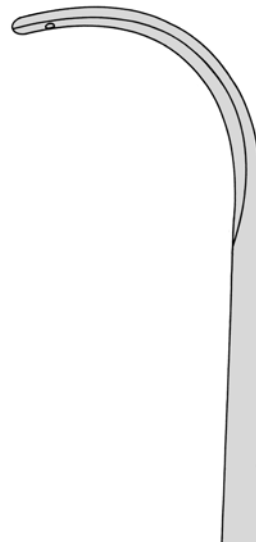

40.0763
24 cm #2

ATRAUMISCHE KLEMMEN
ATRAUMATIC CLAMPS
PINCES ATRAUMATIQUES
PINZAS ATRAUMATICAS
PINZE ATRAUMATICHE

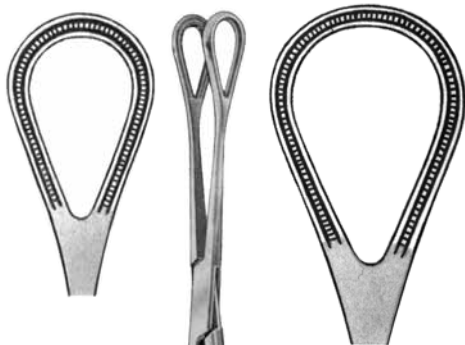

15.1580

15.1582

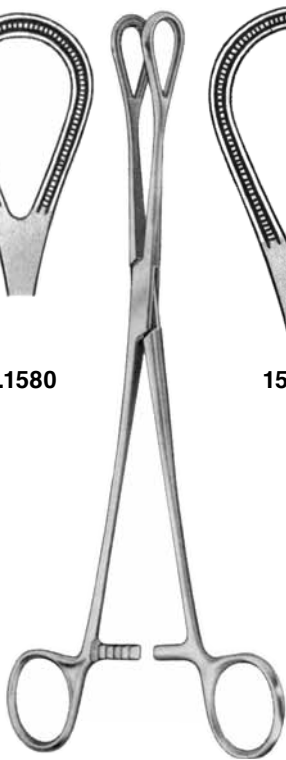

DEBAKEY
 25 cm

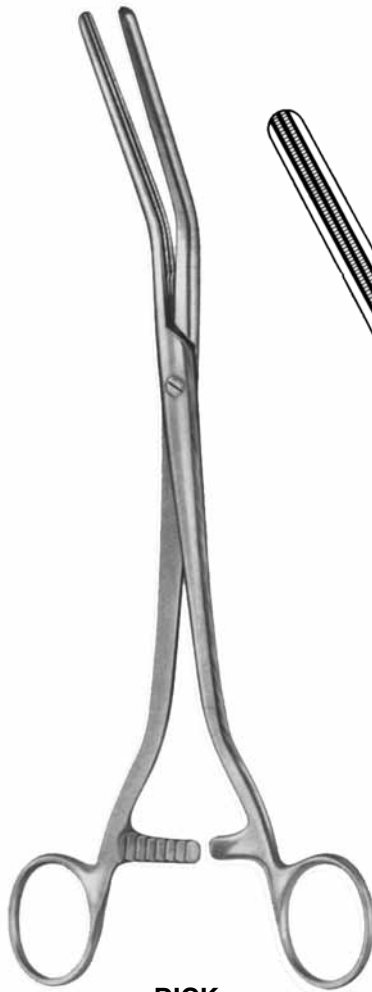

DICK

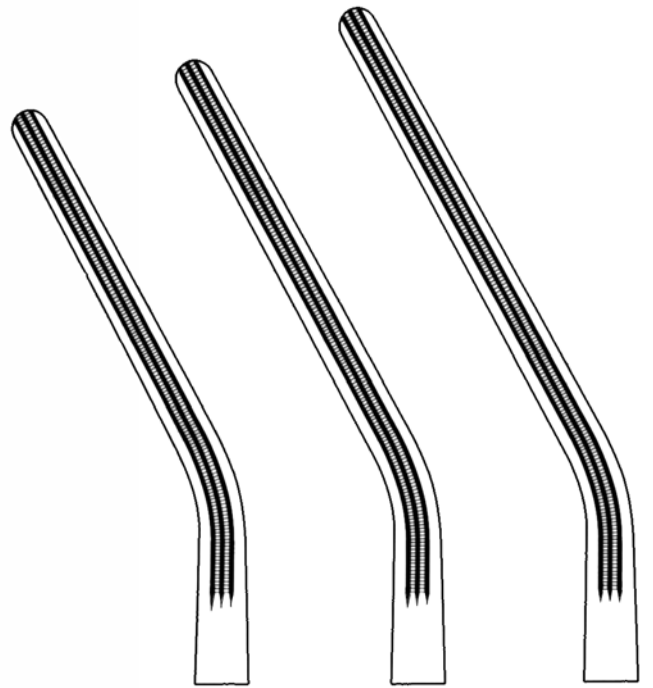

15.2230
25 cm

15.2232
26 cm

15.2234
27 cm

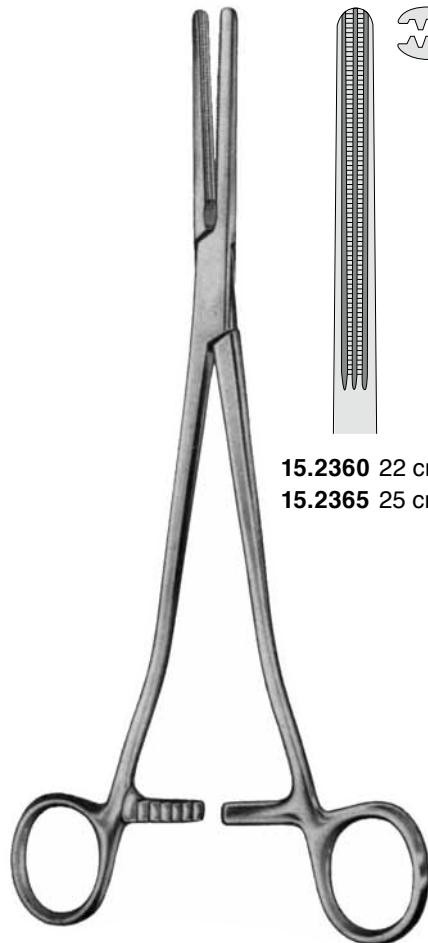

WERTHEIM-DEBAKEY

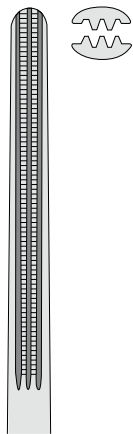

15.2360 22 cm
 15.2365 25 cm

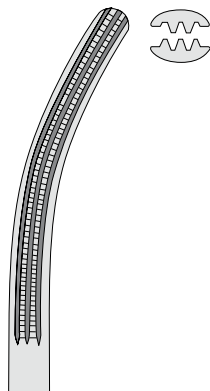

15.2361 22 cm
 15.2366 25 cm

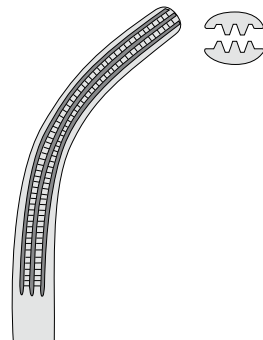

15.2362 21 cm
 15.2367 25 cm

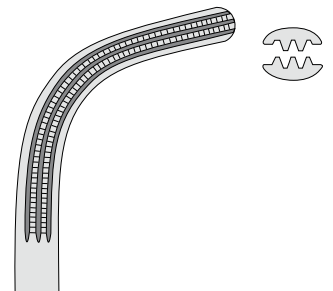

15.2363 20 cm
 15.2368 24 cm

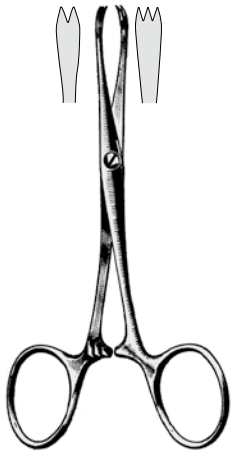

CHAPUT
 15.1200 12 cm



TUFFIER
 15.1204 13 cm



ALLEN-KOCHER

15.1270
 15,5 cm



15.1272
 20 cm



PENNINGTON
 15.1300 15 cm
 15.1302 20 cm



ALLIS-BABY
 48.0004 13 cm, 4 x 5
 48.0006 14 cm, 4 x 5

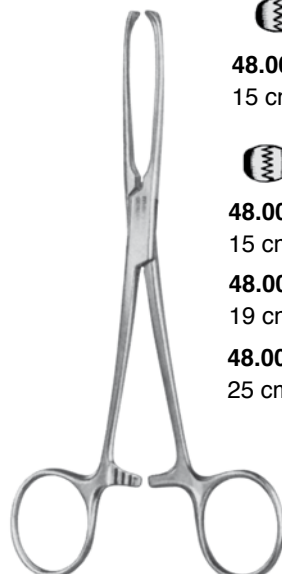

ALLIS



48.0010
 15 cm, 4 x 5

48.0011

15 cm, 5 x 6

48.0014
 19 cm, 5 x 6

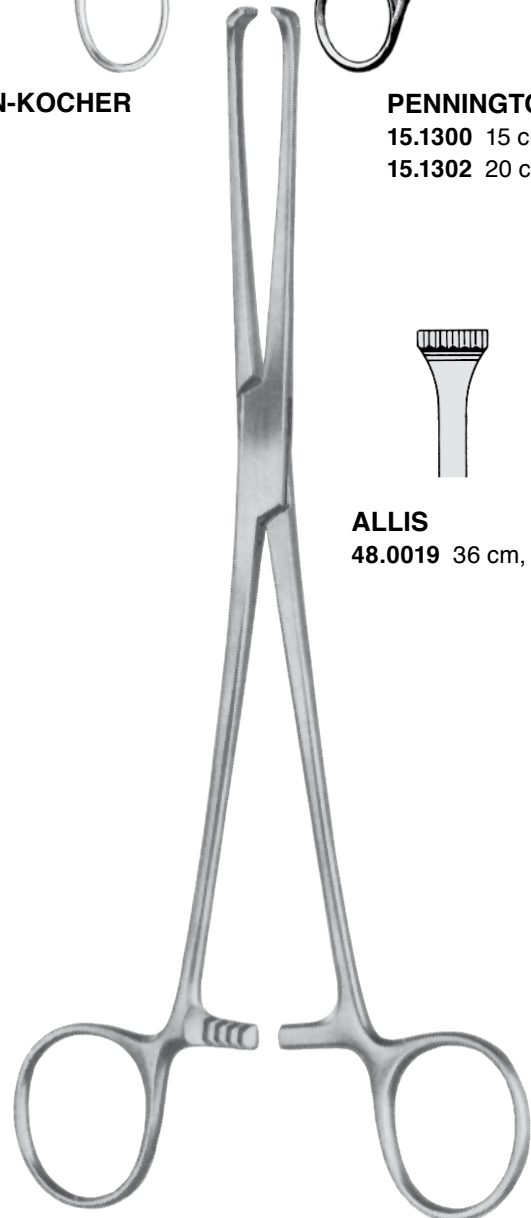
48.0016
 25 cm, 5 x 6



ALLIS
 48.0019 36 cm, 5 x 6

GEWEBE- UND ORGANFASSZANGEN
 TISSUE- AND ORGAN HOLDING FORCEPS
 PINCES POUR SAISIR TISSUS ET ORGANES
 PINZAS PARA TEJIDOS Y ORGANOS
 PINZE PER AFFERARE TESSUTI E ORGANI

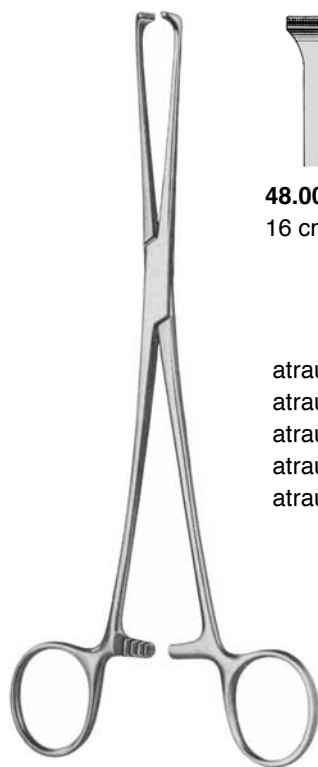

ALLIS

48.0020
16 cm

atraumatisch
 atraumatic
 atraumatique
 atraumática
 atraumatiche

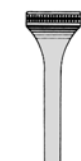

48.0024
20 cm

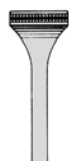

48.0028
25 cm



48.0029
30 cm



ALLIS-ADAIR
48.0030 15,5 cm



JUDD-ALLIS
 48.0032 15 cm
 48.0034 19 cm
 3 x 4

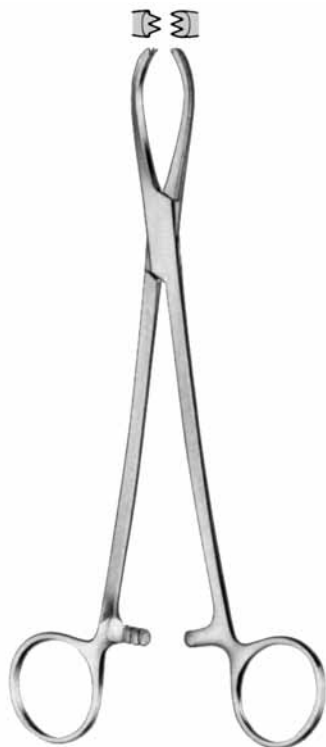

LITTLEWOOD
 48.0035 19 cm
 2 x 3



BOYS-ALLIS
 48.0036 15 cm



THOMS-ALLIS
 48.0038 20 cm
 6 x 7

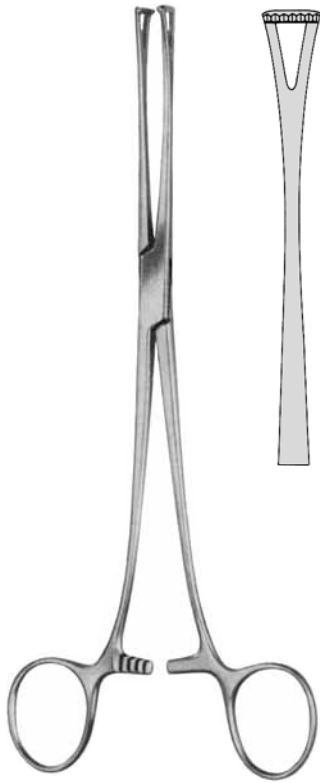

LOCKWOOD
 48.0040 19,5 cm

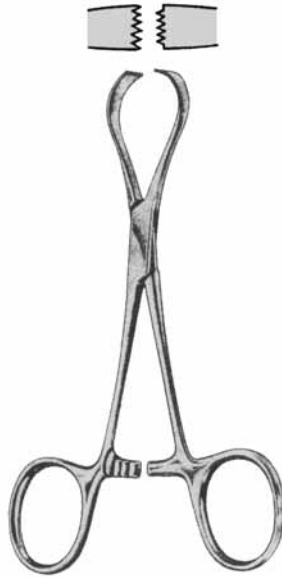

OMBREDANNE
 48.0050 13,5 cm



WILLIAMS
 48.0045 16,5 cm



BABCOCK
 48.0062 16 cm

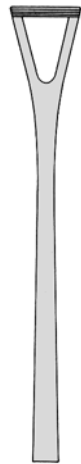

48.0064
 18 cm

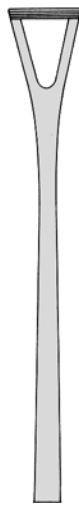

48.0066
 20 cm

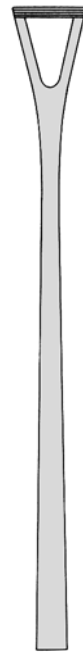

48.0068
 24 cm

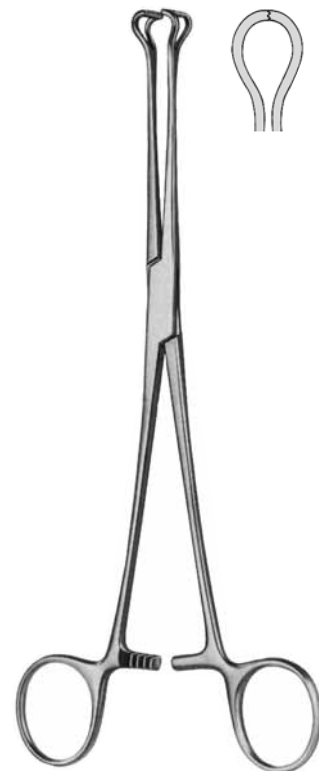

BABCOCK-DEBAKEY
 48.0069 36 cm

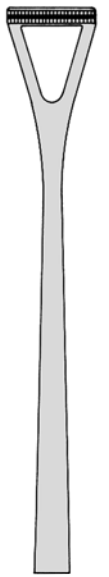

GEWEBE- UND ORGANFASSZANGEN
TISSUE- AND ORGAN HOLDING FORCEPS
PINCES POUR SAISIR TISSUS ET ORGANES
PINZAS PARA TEJIDOS Y ORGANOS
PINZE PER AFFERARE TESSUTI E ORGANI



BABCOCK



48.0072
16 cm

48.0074
18 cm



48.0076
20 cm

48.0078
24 cm

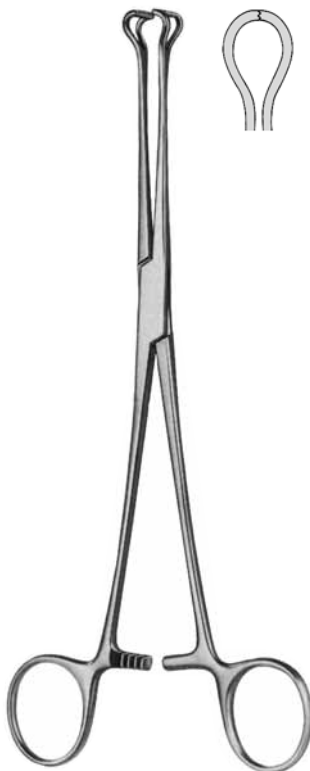

BABCOCK-DEBAKEY

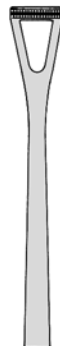

48.0082
16 cm

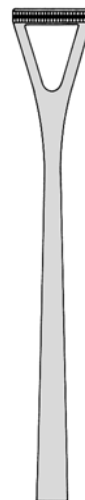

48.0086
20 cm

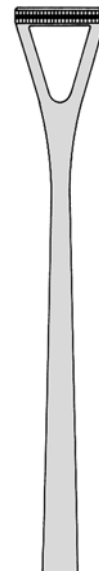

48.0088
23 cm



COLLIN
48.0089
 14 cm



DUVAL



48.0090
 18 cm / 14 mm
48.0092
 20 cm / 14 mm

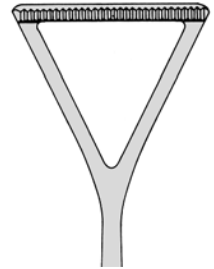

48.0094
 20 cm / 25 mm
48.0098
 23 cm / 25 mm

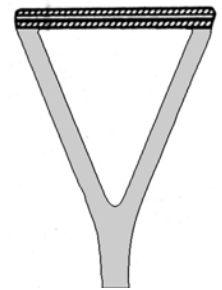

48.0094AT
 20 cm / 20 mm
48.0098AT
 23 cm / 25 mm

atraumatisch
 atraumatic
 atraumatique
 atraumática
 atraumatiche



DUVAL



48.0099
 20 cm / 15 mm



15.1580
25 cm



15.1582
27 cm



DEBAKEY

atraumatisch
atraumatic
atraumatique
atraumática
atraumatiche

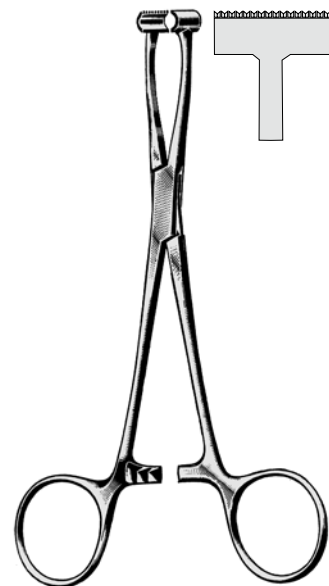

PRATT

15.1350 15 cm