

ARTERIENKLEMMEN, PRÄPARIERKLEMMEN
HEMOSTATIC- AND DISSECTING FORCEPS
PINCES HEMOSTATIQUES ET A PREPARATION
PINZAS HEMOSTATICAS Y PARA PREPARACIONES
PINZE EMOSTATICHE E PER PREPARAZIONE

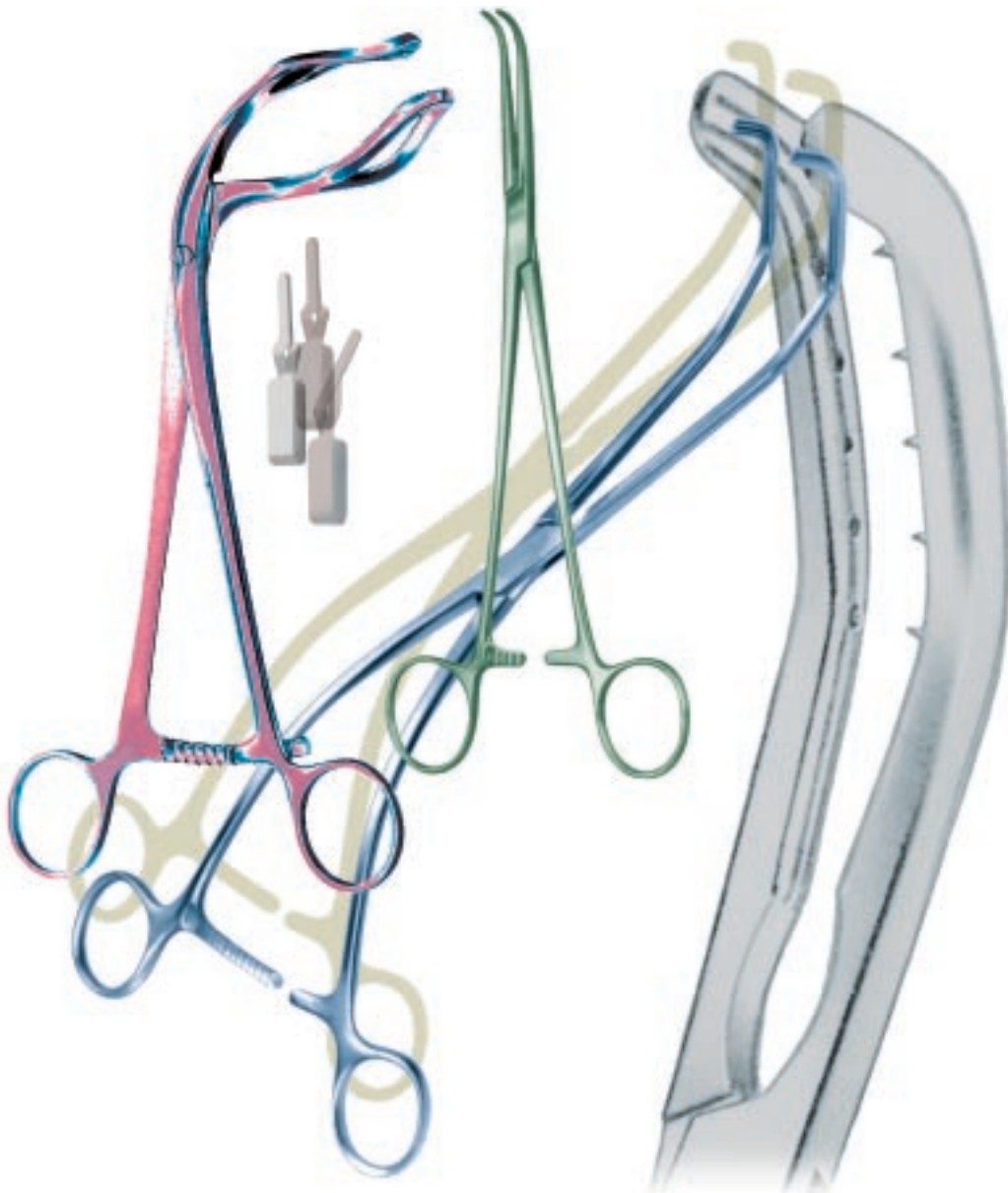

MINI-GEFÄSSCLIPS, BULLDOGKLEMMEN
 MINI-VESSEL CLIPS, BULLDOG CLAMPS
 MINI CLIPS VASCULAIRES, CLAMPS BULLDOG
 MINI CLIPS VASCULARES, CLAMPS BULLDOG
 MINI-CLIP VASCOLARI, PINZE BULLDOG

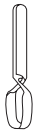

MICRO-CLIP
15.0001
 10 x 2 mm
 60 gr.



MICRO-CLIP
15.0002
 8 x 2 mm
 85 gr.



MICRO-CLIP
15.0003
 6 x 1 mm
 100 gr.



MICRO-CLIP
15.0004
 4 x 0,75 mm
 125 gr.



MICRO-CLIP
15.0005
 6 x 1 mm
 45°, 70 gr.



MICRO-CLIP
15.0006
 6 x 1 mm
 70 gr.



15.0008 14 cm



15.0009 18 cm

Anlegezangen
 applying forceps
 pinces à appliquer
 pinzas para poner
 pinze per applicare



JOHNS-HOPKINS
15.0040 23 cm
 Anlegezange
 applying forceps
 pince à appliquer
 pinza para poner
 pinza per applicare



DIEFFENBACH
15.0010 3,5 cm



DIEFFENBACH
15.0011 3,5 cm



DIEFFENBACH
15.0012 5 cm



DIEFFENBACH
15.0013 5 cm



DIEFFENBACH
15.0014 6 cm

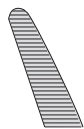

DIEFFENBACH
15.0015 6 cm



JOHNS-HOPKINS
15.0020 38 mm
15.0022 50 mm
15.0024 57 mm
15.0026 63 mm
15.0028 70 mm
15.0030 76 mm
15.0032 90 mm



JOHNS-HOPKINS
15.0021 38 mm
15.0023 50 mm
15.0025 57 mm
15.0027 63 mm
15.0029 70 mm
15.0031 76 mm
15.0033 90 mm



SCHWARTZ
15.0050 25 mm



SCHWARTZ
15.0051 25 mm



SCHWARTZ
15.0053 25 mm



SCHWARTZ
15.0058 19 cm

Anlegezange
Applying forceps
pince à appliquer
pinza para poner
pinza per applicare



MINI-SERREFINE
15.0060 28 mm



MINI-SERREFINE
15.0061 28 mm

ATRAUMATISCHE BULLDOGKLEMMEN
NON-TRAUMATIC BULLDOG CLAMPS
CLAMPS BULLDOG NON-TRAUMATISANTS
CLAMPS BULLDOG ATRAUMATICAS
CLAMPS ATRAUMA BULLDOG



GLOVER



GLOVER

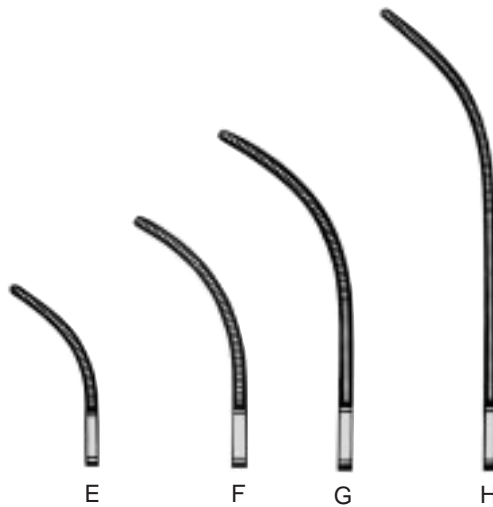

| Artikel Item | Fig. | Gesamtlänge Overall length Longeur complet largo total Lunghezza total | Maullänge Jaw length longeur de mors largo de boca Lunghezza del morso | Gewicht Weight Poids Peso Peso |
|-----------------|------|--|--|--|
| 41.0000 | A | 60 mm | 20 mm | 5 g |
| 41.0001 | E | 55 mm | 20 mm | 5 g |
| 41.0005 | B | 70 mm | 30 mm | 9 g |
| 41.0006 | F | 65 mm | 30 mm | 9 g |
| 41.0010 | C | 90 mm | 43 mm | 12 g |
| 41.0011 | G | 85 mm | 43 mm | 12 g |
| 41.0015 | D | 105 mm | 56 mm | 14 g |
| 41.0016 | H | 100 mm | 56 mm | 14 g |
| 41.0019 | J | 55 mm | 25 mm | 7 g |



GREGORY

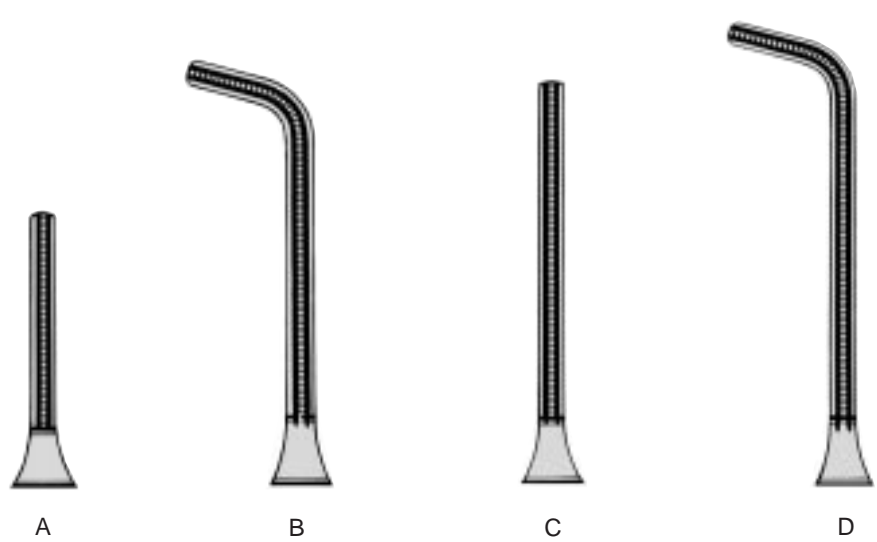

| Artikel Item | Fig. | Gesamtlänge Overall length Longeur complet largo total Lunghezza total | Maullänge Jaw length longeur de mors largo de boca Lunghezza del morso | Gewicht Weight Poids Peso Peso |
|-----------------|------|--|--|--|
| 41.0020 | A | 90 mm | 27 mm | 11 g |
| 41.0021 | B | 100 mm | 44 mm | 12 g |
| 41.0022 | C | 110 mm | 55 mm | 12 g |
| 41.0023 | D | 110 mm | 60 mm | 12 g |



GREGORY

nach links gebogen
 curved to left
 courbe à gauche
 curva a la izquierda
 curvo a sinistra



A

nach rechts gebogen
 curved to right
 courbe à droit
 curva a la derecha
 curvo a destra



B

| Artikel Item | Fig. | Gesamtlänge Overall length Longeur complet largo total Lunghezza total | Maullänge Jaw length longeur de mors largo de boca Lunghezza del morso | Gewicht Weight Poids Peso Peso |
|-----------------|------|--|--|--|
| 41.0024 | A | 110 mm | 60 mm | 12 g |
| 41.0025 | B | 110 mm | 60 mm | 12 g |

ATRAUMATISCHE BULLDOGKLEMMEN
NON-TRAUMATIC BULLDOG CLAMPS
CLAMPS BULLDOG NON-TRAUMATISANTS
CLAMPS BULLDOG ATRAUMATICAS
CLAMPS ATRAUMA BULLDOG



30 mm Maullänge
 Jaw length
 longueur de mors
 largo de boca
 Lunghezza del morso

SANTULLI
41.0028
 70 mm

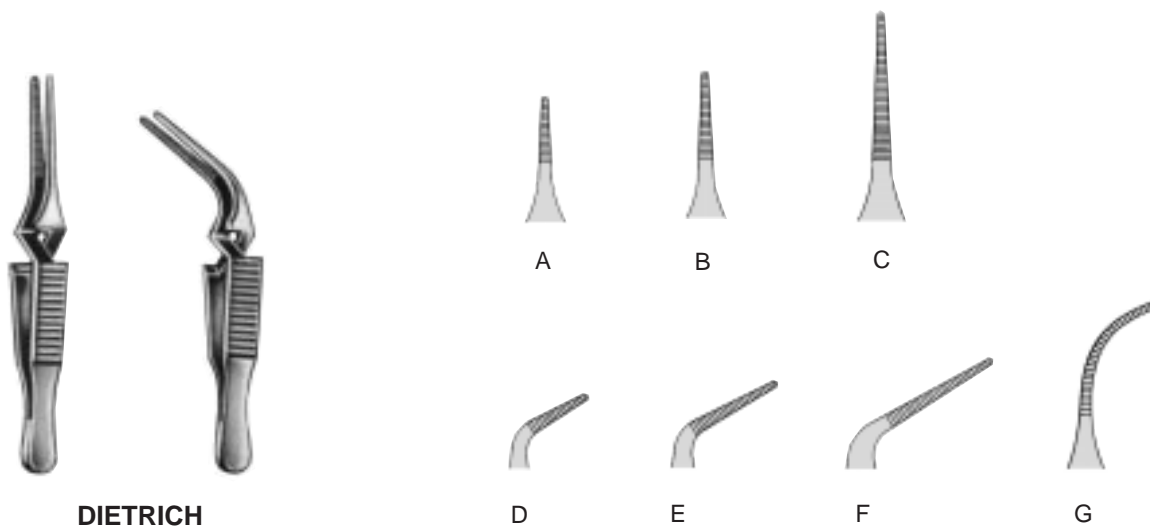

DIETRICH

| Artikel Item | Fig. | Gesamtlänge Overall length Longeur complet largo total Lunghezza total | Maullänge Jaw length longueur de mors largo de boca Lunghezza del morso | Gewicht Weight Poids Peso Peso | Schliesdruck Closing pressure Pression d'Occlusion Presión de cierre Pressione di chiusura |
|-----------------|------|--|---|--|--|
| 41.0030 | A | 50 mm | 8 mm | 3 g | 80 |
| 41.0031 | D | 43 mm | 8 mm | 3 g | 80 |
| 41.0032 | B | 53 mm | 12 mm | 3 g | 80 |
| 41.0033 | E | 45 mm | 12 mm | 3 g | 80 |
| 41.0034 | C | 60 mm | 20 mm | 3 g | 80 |
| 41.0035 | F | 50 mm | 20 mm | 3 g | 80 |
| 41.0037 | G | 54 mm | 20 mm | 3 g | 80 |

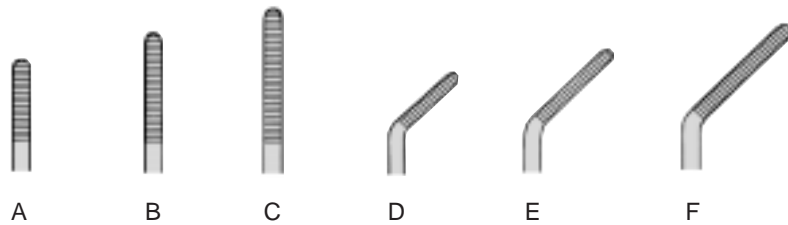

FEDERLEICHT • FEATHERLIGHT • POIDS PLUME • MUY LIGERO

| Artikel Item | Fig. | Gesamtlänge Overall length Longeur complet largo total Lunghezza total | Maullänge Jaw length longeur de mors largo de boca Lunghezza del morso | Gewicht Weight Poids Peso Peso | Schliessdruck Closing pressure Pression d'Occlusion Presión de cierre Pressione di chiusura |
|-----------------|------|--|--|--|---|
| 41.0040 | A | 31 mm | 10 mm | 1 g | 30 |
| 41.0041 | B | 35 mm | 14 mm | 1 g | 30 |
| 41.0042 | C | 39 mm | 18 mm | 1 g | 30 |
| 41.0043 | D | 30 mm | 10 mm | 1 g | 30 |
| 41.0044 | E | 33 mm | 14 mm | 1 g | 30 |
| 41.0045 | F | 36 mm | 18 mm | 1 g | 30 |



WICKHAM

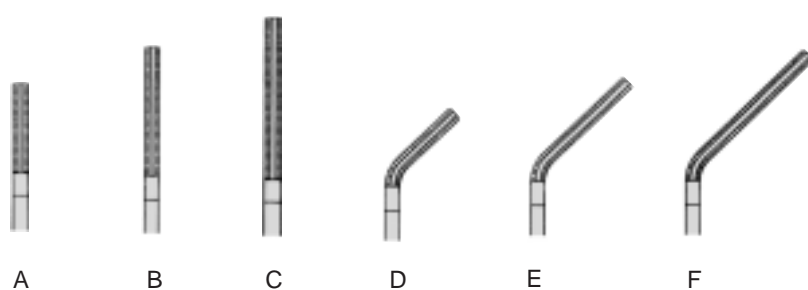

| Artikel Item | Fig. | Gesamtlänge Overall length Longeur complet largo total Lunghezza total | Maullänge Jaw length longeur de mors largo de boca Lunghezza del morso | Gewicht Weight Poids Peso Peso | Schliessdruck Closing pressure Pression d'Occlusion Presión de cierre Pressione di chiusura |
|-----------------|------|--|--|--|---|
| 41.0080 | A | 49 mm | 13 mm | 3 g | 150 |
| 41.0081 | D | 47 mm | 13 mm | 3 g | 150 |
| 41.0082 | B | 54 mm | 18 mm | 3 g | 150 |
| 41.0083 | E | 51 mm | 18 mm | 3 g | 150 |
| 41.0084 | C | 61 mm | 25 mm | 3 g | 150 |
| 41.0085 | F | 55 mm | 25 mm | 3 g | 150 |

WICKHAM

41.0089 24 cm

Anlegezange / Applying forceps / Pince à pos / Pinza de aplicación / Pinza per metti-rimovi



TITAN MINIATUR- BULLDOG-CLIPS
TITAN MINIATURE- BULLDOG-CLIPS
TITAN CLAMPS BULLDOG MINIATURE
TITAN CLAMPS BULLDOG MINIATURA
TITAN PINZE BULLDOG MINIATURA

TITANIUM

Identification:

A = ARTERIA

= closing force
 220 - 240 ± 10 g

V = VENA

= closing force
 110 - 130 ± 10 g

Anlege- u. Entfernungszange für
 TITAN Miniatur-Bulldog-Clips

Applying- and removing Forceps for
 TITAN Miniature Bulldog-Clips

Pinces pour poser et retirer les
 TITAN Clips Bulldog

Pinza para poner y quitar TITAN
 Miniature clips Bulldog

Pinza per metti-rimouvi TITAN
 Clips Bulldog



3,0 cm

41.0050A
 41.0050V



3,5 cm

41.0052A
 41.0052V



4,0 cm

41.0054A
 41.0054V



4,5 cm

41.0056A
 41.0056V



3,0 cm

41.0051A
 41.0051V



3,5 cm

41.0053A
 41.0053V



4,0 cm

41.0055A
 41.0055V



4,5 cm

41.0057A
 41.0057V



41.0069
 23 cm



3,0 cm

41.0061A
 41.0061V



3,5 cm

41.0063A
 41.0063V



4,0 cm

41.0065A
 41.0065V



4,5 cm

41.0067A
 41.0067V



DEBAKEY-MICRO

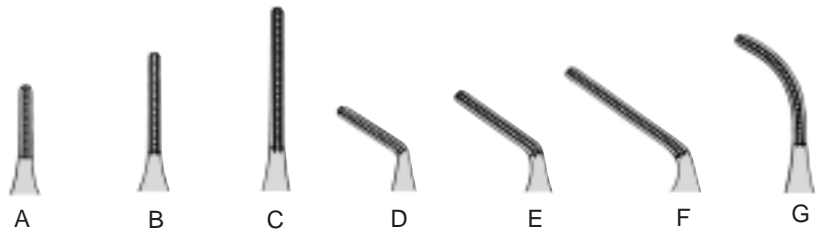

| Artikel Item | Fig. | Gesamtlänge Overall length Longeur complet largo total Lunghezza total | Maullänge Jaw length longeur de mors largo de boca Lunghezza del morso | Gewicht Weight Poids Peso Peso | Schliessdruck Closing pressure Pression d'Occlusion Presión de cierre Pressione di chiusura |
|--------------|------|--|--|--|---|
| 41.0090 | A | 47 mm | 10 mm | 3 g | 180 |
| 41.0091 | D | 44 mm | 10 mm | 3 g | 180 |
| 41.0092 | B | 51 mm | 14 mm | 3 g | 180 |
| 41.0093 | E | 46 mm | 14 mm | 3 g | 180 |
| 41.0094 | C | 57 mm | 20 mm | 3 g | 180 |
| 41.0095 | F | 49 mm | 20 mm | 3 g | 180 |
| 41.0099 | G | 54 mm | 20 mm | 3 g | 180 |



DEBAKEY

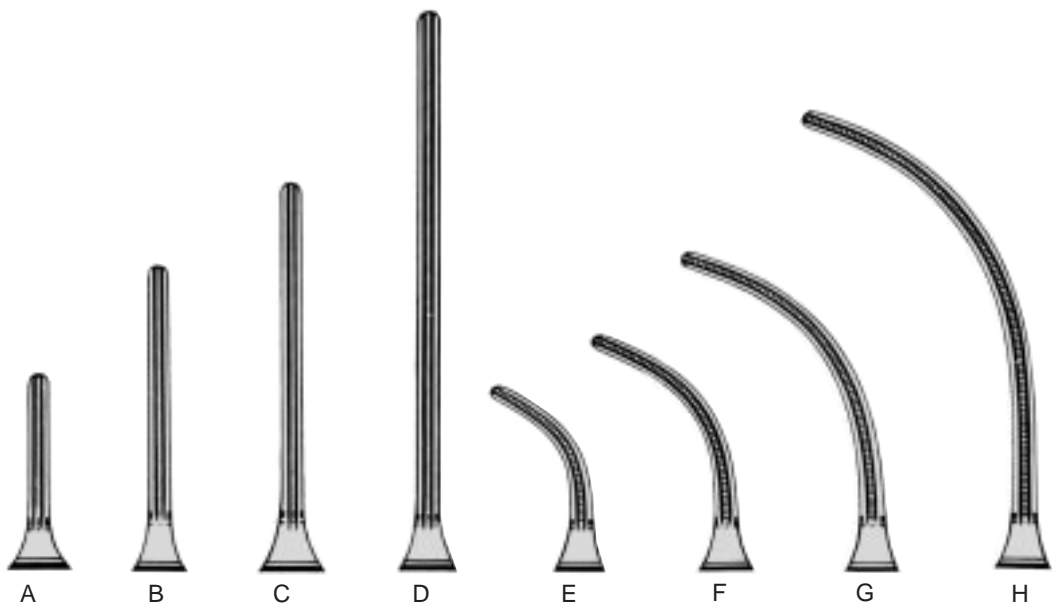

| Artikel Item | Fig. | Gesamtlänge Overall length Longeur complet largo total Lunghezza total | Maullänge Jaw length longeur de mors largo de boca Lunghezza del morso | Gewicht Weight Poids Peso Peso |
|--------------|------|--|--|--|
| 41.0100 | A | 80 mm | 20 mm | 10 g |
| 41.0101 | E | 75 mm | 20 mm | 10 g |
| 41.0110 | B | 90 mm | 30 mm | 11 g |
| 41.0111 | F | 85 mm | 30 mm | 11 g |
| 41.0115 | C | 105 mm | 45 mm | 12 g |
| 41.0116 | G | 95 mm | 45 mm | 12 g |
| 41.0120 | D | 125 mm | 68 mm | 12 g |
| 41.0121 | H | 115 mm | 68 mm | 12 g |



DEBAKEY
41.0130
12.5 cm



DEBAKEY
41.0132
12.5 cm



DEBAKEY
41.0134
12.5 cm 45°



DEBAKEY
41.0136
10 cm 90°



DEBAKEY
41.0138
12.5 cm



DEBAKEY-SATINSKY

41.0140 5,5 cm

41.0144 6,5 cm

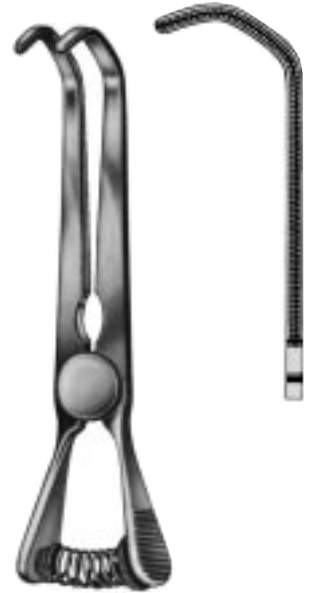

DEBAKEY-SATINSKY

41.0146 10 cm



DEBAKEY-CAROTID

41.0147 9 cm



CARREL
 15.0098 8,5 cm



HARTMANN
 10 cm



15.0100



15.0108
 glattes Maul
 smooth jaws
 lisses
 lisas
 liscio



HARTMANN
 15.0101 10 cm

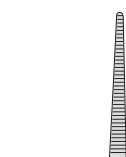

HARTMANN-MICRO
 15.0102 10 cm



HARTMANN-MICRO
 15.0103 10 cm



HARTMANN
 15.0104 10 cm 1x2



HARTMANN
 15.0105 10 cm 1x2

TITANIUM



JACOBSON-MICRO
15.0116 12,5 cm

15.0117

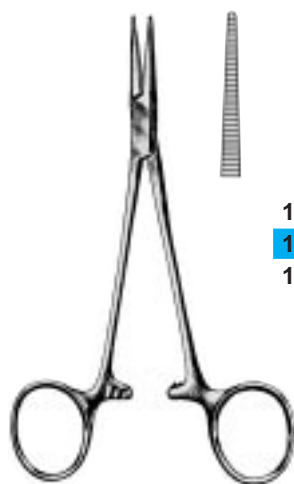

MOSQUITO
15.0120 12,5 cm
15.0120L 12,5 cm
15.0120T 12,5 cm
15.0124 14 cm

15.0121 12,5 cm
15.0121T 12,5 cm
15.0125 14 cm

15.0121L



MICRO-MOSQUITO
15.0122 12,5 cm

15.0123



MICRO-MOSQUITO
15.0128 12 cm 1x2

15.0129 1x2



MOSQUITO
15.0126 12,5 cm 1x2
15.0136 14 cm 1x2

15.0127 12,5 cm 1x2
15.0137 14 cm 1x2



MICRO-MOSQUITO
15.0139 12,5 cm
kreuzgerieft / cross-serrated
rainures croisées
estriada en forma de cruz
striatura cruciforme

TITANIUM

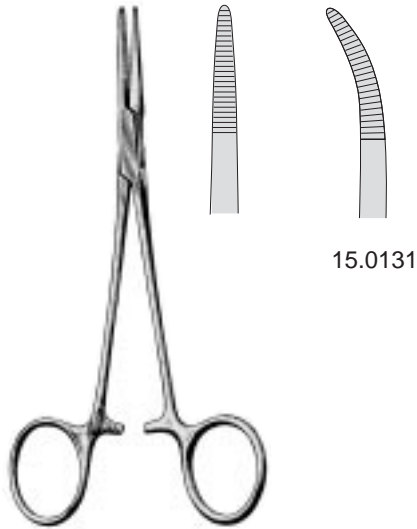

15.0131

PROVIDENCE-HOSPITAL
 15.0130 14,5 cm



15.0181

DUNHILL
 15.0180 12,5 cm



15.0201
15.0201T

KELLY
 15.0200 14 cm
15.0200T 14 cm



CRILE
 15.0210 14 cm
15.0210T 14 cm



15.0211
15.0211T

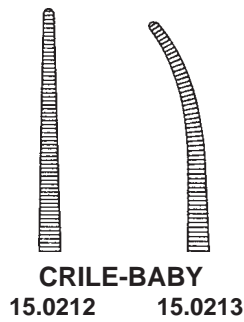

CRILE-BABY
 15.0212 15.0213

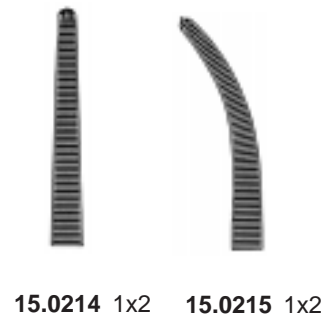

15.0214 1x2 15.0215 1x2



DANDY-MOSQUITO
 15.0218 12 cm



DANDY
 14,5 cm

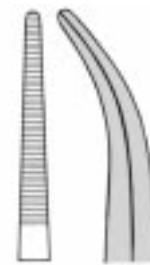

15.0220

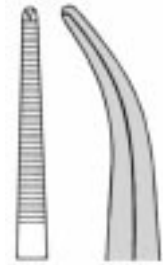

15.0222 1x2



LOVELACE
 15,5 cm

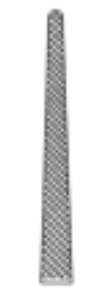

15.0224



15.0225 1x2



LERICHE
 15 cm



15.0230



15.0231



15.0236 1x2



15.0237 1x2

ARTERIENKLEMMEN
HEMOSTATIC FORCEPS
PINCES HÉMOSTATIQUES
PINZAS HEMOSTÁTICAS
PINZE EMOSTATICHE



15.0240

15.0241

RANKIN-KELLY
 16 cm



15.0251

RANKIN-CRILE
 15.0250 16 cm



15.0253
1x2

RANKIN-CRILE
 15.0252 16 cm 1x2



15.0260
14 cm

15.0262
16 cm

15.0261
14 cm

15.0263
16 cm

COLLER-CRILE



HALSTED

15.0300 18 cm

15.0302 21 cm

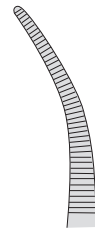

15.0301 18 cm

15.0303 21 cm



15.0306 18 cm 1x2

15.0308 21 cm 1x2

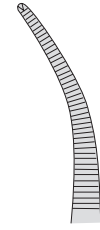

15.0307 18 cm 1x2

15.0309 21 cm 1x2



ADSON-BABY

15.0313 14 cm



15.0315

18 cm



ADSON

15.0310 18,5 cm

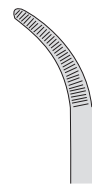

15.0311

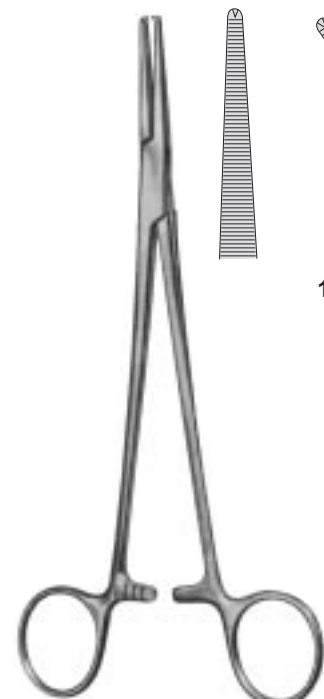

ADSON

15.0316 18,5 cm 1x2

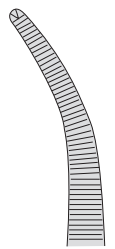

15.0317 1x2

PRÄPARIER- UND LIGATURKLEMMEN
 DISSECTING AND LIGATURE FORCEPS
 PINCES A DISSEQUER ET A LIGATURES
 PINZAS PARA DISECCION Y LIGATURAS
 PINZE PER PREPARAZIONI E LEGATURE



HEISS
 15.0320 20 cm



15.0321 15.0323 15.0324 15.0325
 1x2 1x2



FUCHSIG
 15.0331 18,5 cm



NISSEN
 15.0335 19 cm

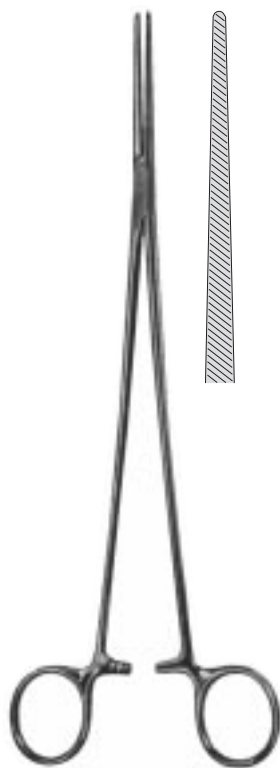

BENGOLEA
 15.0360 20 cm
 15.0362 26 cm

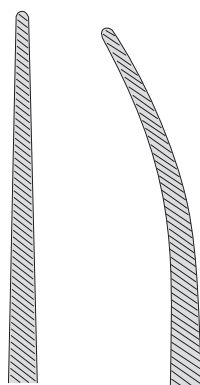

15.0361 20 cm
 15.0363 26 cm

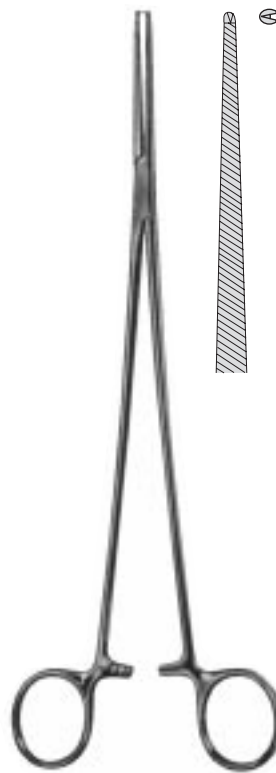

BENGOLEA
 15.0364 20 cm 1x2
 15.0366 26 cm 1x2

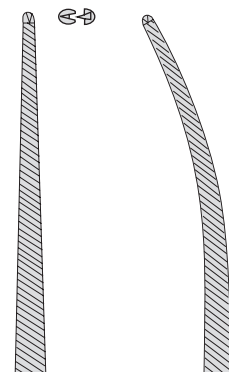

15.0365 20 cm 1x2
 15.0367 26 cm 1x2



BRIDGE
 15.0392 28 cm



15.0393
 28 cm

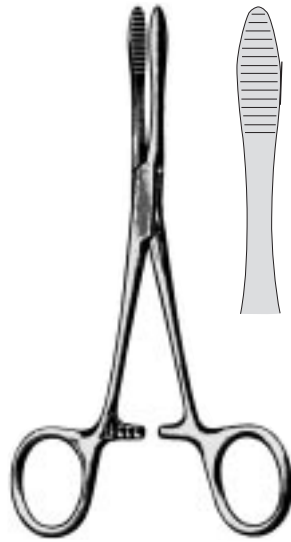

PEAN
 15.0404 12,5 cm
 15.0406 14,5 cm
 15.0408 16 cm



SPENCER-WELLS
 15.0410 13 cm
 15.0412 14 cm
 15.0414 15 cm
 15.0416 18 cm
 15.0418 20 cm

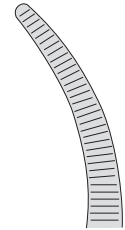

SPENCER-WELLS
 15.0411 13 cm
 15.0413 14 cm
 15.0415 15 cm
 15.0417 18 cm
 15.0419 20 cm



ROCH-CARMALT
 15.0430 16 cm
 15.0432 20 cm

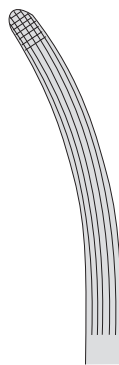

15.0431 16 cm
 15.0433 20 cm



BAINBRIDGE
 15.1320 15,5 cm
 15.1322 18,0 cm

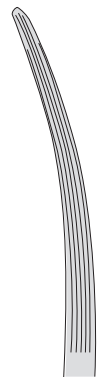

15.1321 15,5 cm
 15.1323 18,0 cm

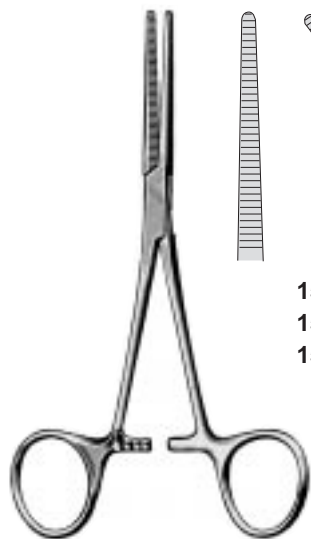

15.0451 13 cm
 15.0453 14 cm
 15.0455 16 cm

PEAN-FINO

15.0450 13 cm
 15.0452 14 cm
 15.0454 16 cm



15.0459 13 cm
 15.0461 14 cm
 15.0463 16 cm
 15.0465 18 cm
 15.0467 20 cm
 15.0469 22 cm
 15.0471 24 cm
 15.0473 26 cm
 15.0477 30 cm

ROCHESTER-PEAN

15.0458 13 cm
 15.0460 14 cm
 15.0462 16 cm
 15.0464 18 cm
 15.0466 20 cm
 15.0468 22 cm
 15.0470 24 cm
 15.0472 26 cm
 15.0476 30 cm



15.0481

ROBERTS

15.0480 22 cm



OLIVECRONA

15.0482
18 cm

15.0484
20 cm

15.0486
24 cm



CRAFOORD

15.0492
18 cm

15.0493
20 cm

15.0494
24 cm



CRAFOORD-SELLORS
24 cm

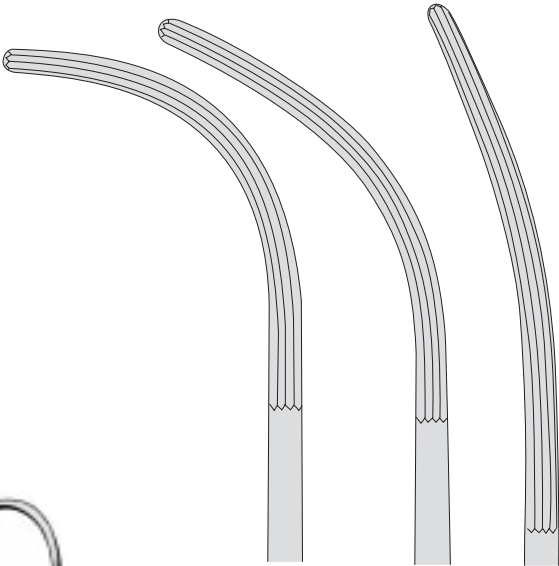

15.0495

15.0496

15.0497



SAROT
 15.0500 24 cm



15.0501



ZENKER
 15.0521 29,5 cm

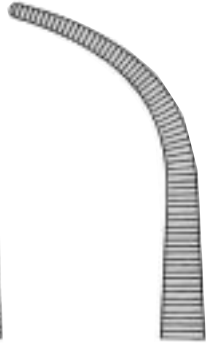
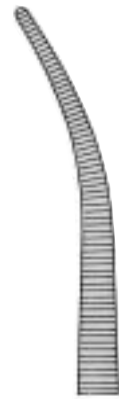

15.0523



KELLY



15.0531
 19 cm

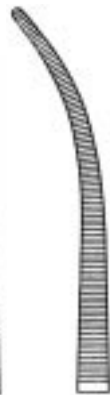

15.0532
 22 cm



15.0533
 24 cm



15.0534
 19 cm



15.0535
 22 cm



15.0536
 24 cm



15.0537
 19 cm



15.0538
 22 cm

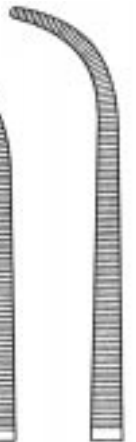

15.0539
 24 cm

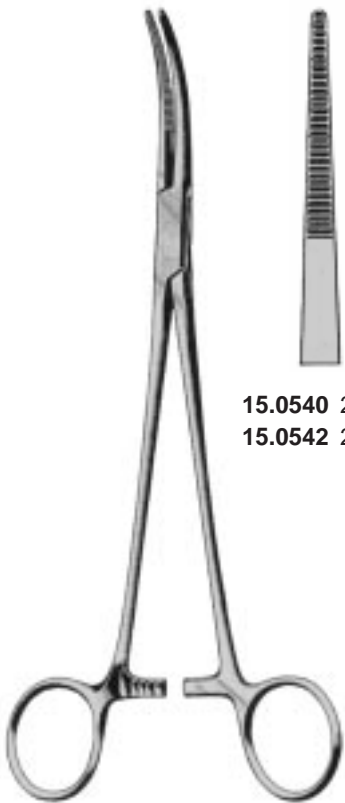

TOENNIS

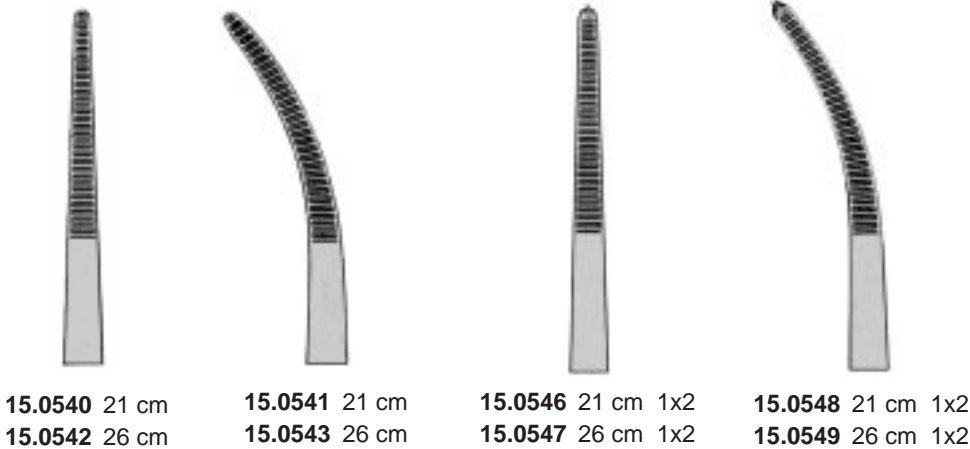

- | | | | |
|----------------------|----------------------|--------------------------|--------------------------|
| 15.0540 21 cm | 15.0541 21 cm | 15.0546 21 cm 1x2 | 15.0548 21 cm 1x2 |
| 15.0542 26 cm | 15.0543 26 cm | 15.0547 26 cm 1x2 | 15.0549 26 cm 1x2 |

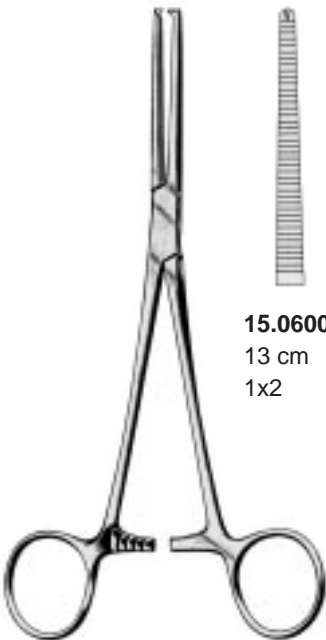

KOCHER

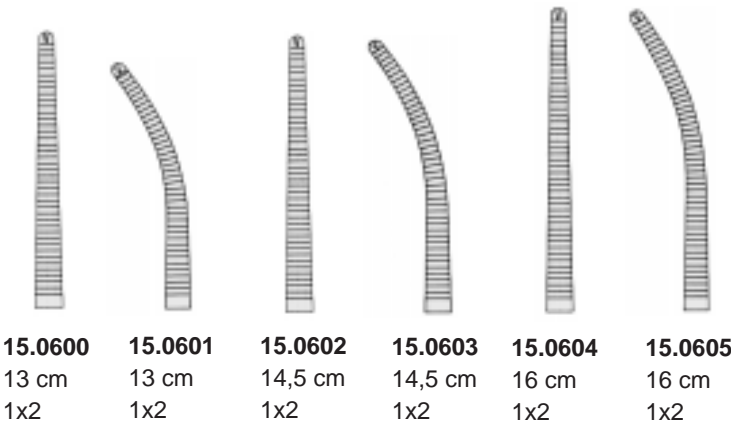

- | | | | | | |
|--------------------------------|--------------------------------|----------------------------------|----------------------------------|--------------------------------|--------------------------------|
| 15.0600 13 cm 1x2 | 15.0601 13 cm 1x2 | 15.0602 14,5 cm 1x2 | 15.0603 14,5 cm 1x2 | 15.0604 16 cm 1x2 | 15.0605 16 cm 1x2 |
|--------------------------------|--------------------------------|----------------------------------|----------------------------------|--------------------------------|--------------------------------|



KOCHER-FINO

- | | |
|----------------------|----------------------|
| 15.0606 14 cm | 15.0608 16 cm |
|----------------------|----------------------|

- | | |
|----------------------|----------------------|
| 15.0607 14 cm | 15.0609 16 cm |
|----------------------|----------------------|



ROCHESTER-OCHSNER

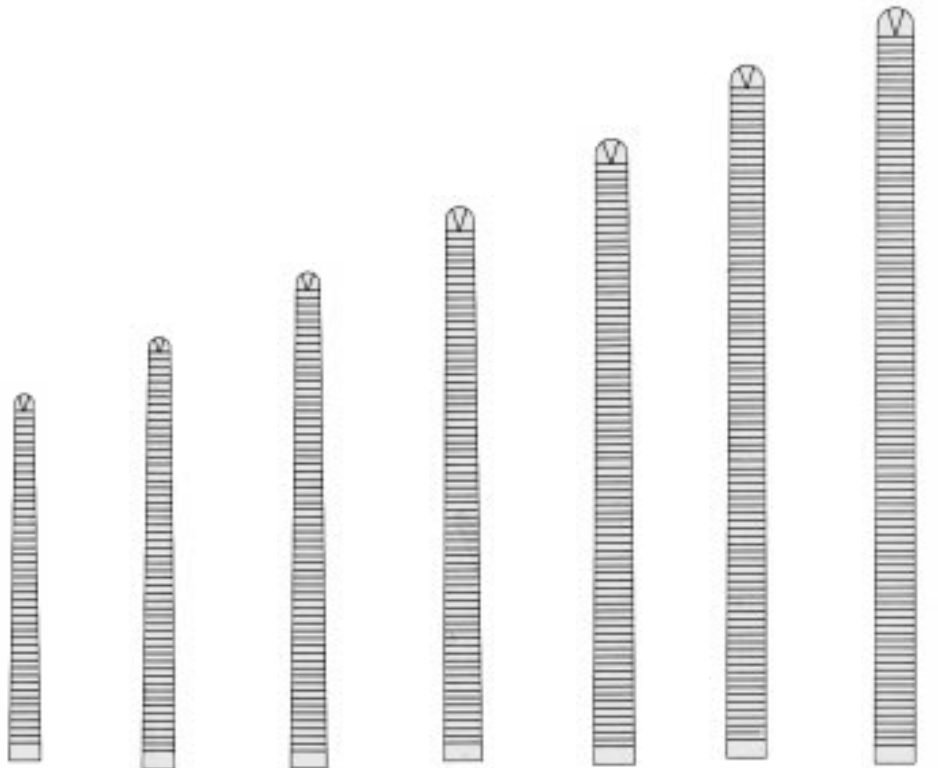

| | | | | | | |
|----------------|----------------|----------------|----------------|----------------|----------------|----------------|
| 15.0620 | 15.0622 | 15.0624 | 15.0626 | 15.0628 | 15.0630 | 15.0632 |
| 16 cm | 18 cm | 20 cm | 22 cm | 24 cm | 26 cm | 30 cm |
| 1x2 | 1x2 | 1x2 | 1x2 | 1x2 | 1x2 | 1x2 |

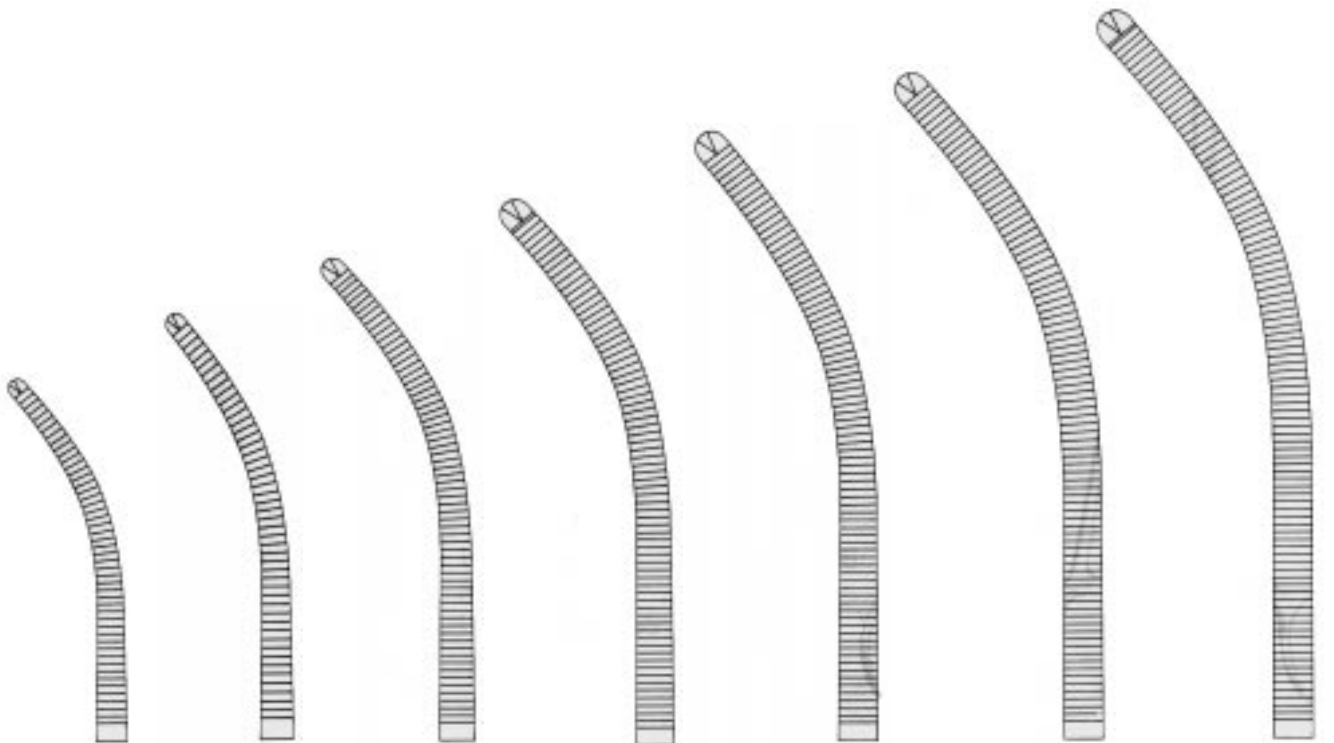

| | | | | | | |
|----------------|----------------|----------------|----------------|----------------|----------------|----------------|
| 15.0621 | 15.0623 | 15.0625 | 15.0627 | 15.0629 | 15.0631 | 15.0633 |
| 16 cm | 18 cm | 20 cm | 22 cm | 24 cm | 26 cm | 30 cm |
| 1x2 | 1x2 | 1x2 | 1x2 | 1x2 | 1x2 | 1x2 |



MIXTER-O'SHAUGHNESSY
 15.0701 15 cm
 15.0703 19 cm



OVERHOLT-BABY
 15.0720 14 cm

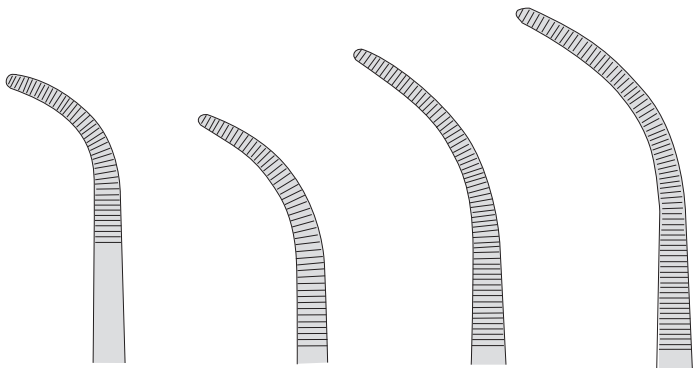

15.0721 #1 15.0722 #2 15.0723 #3 15.0724 #4
 15.1721 #1 15.1722 #2 15.1723 #3 15.1724 #4

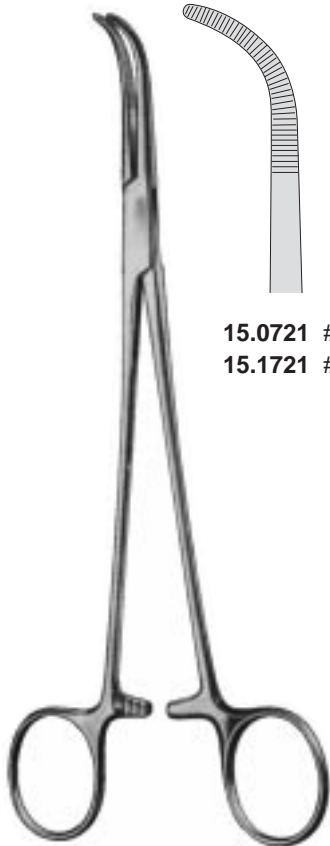

OVERHOLT-GEISSENDOERFER
 15.0721-15.0727 21 cm
 15.1721-15.1727 27 cm

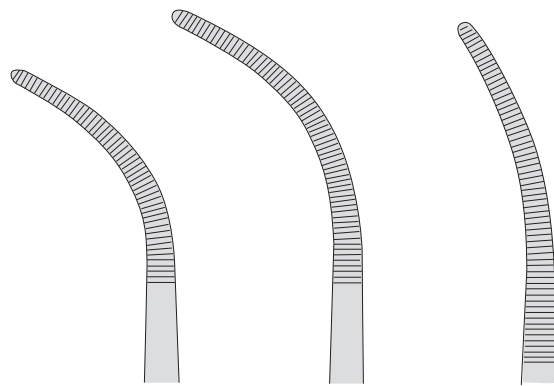

15.0725 #5 15.0726 #6 15.0727 #7
 15.1725 #5 15.1726 #6 15.1727 #7



OVERHOLT-MIXTER
 15.0729 21 cm

PRÄPARIER- UND LIGATURKLEMMEN
 DISSECTING AND LIGATURE FORCEPS
 PINCES A DISSEQUER ET A LIGATURES
 PINZAS PARA DISECCION Y LIGATURAS
 PINZE PER PREPARAZIONI E LEGATURE

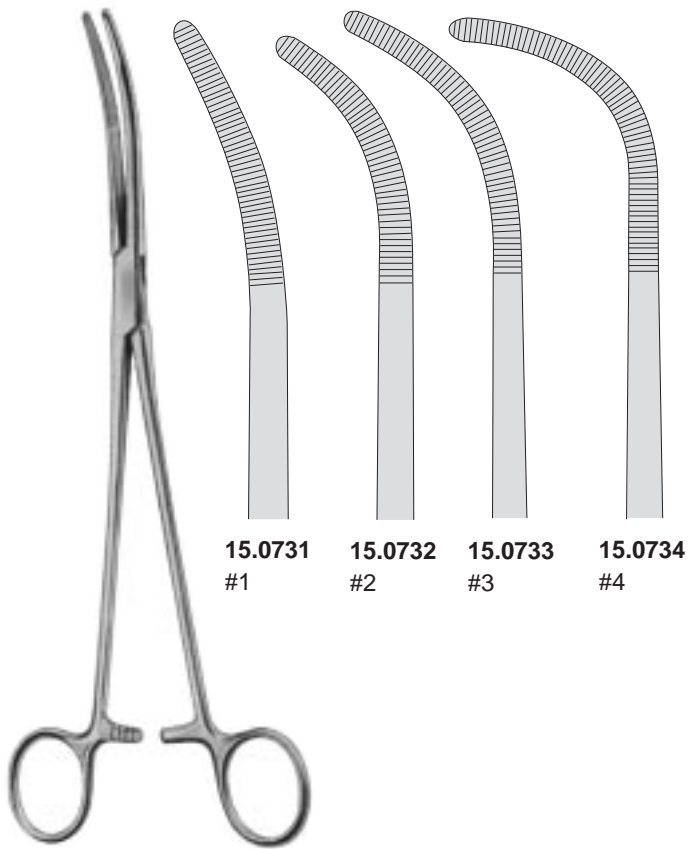

RUMEL
23 cm



KANTROWITZ

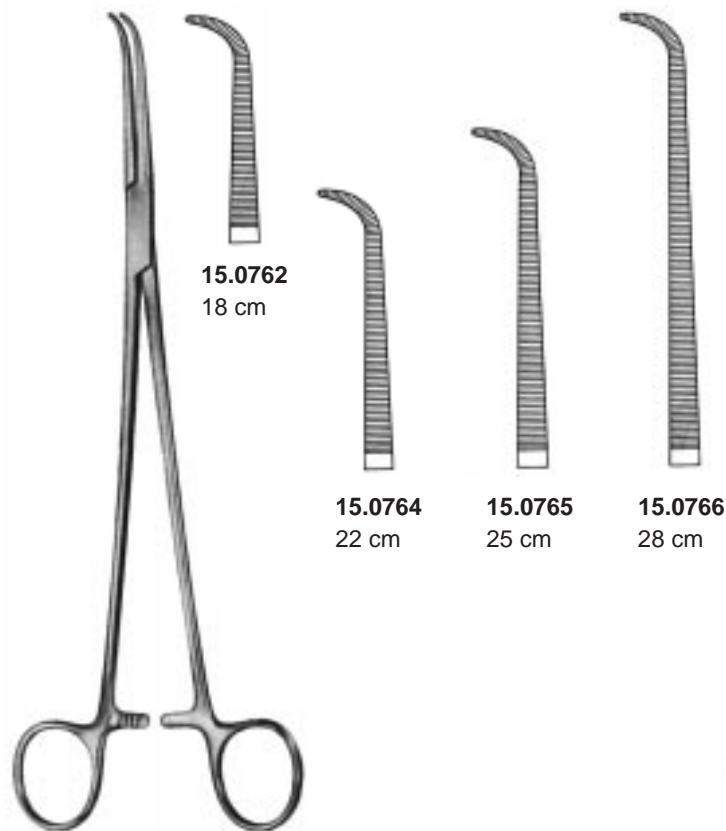

GEMINI-MINI

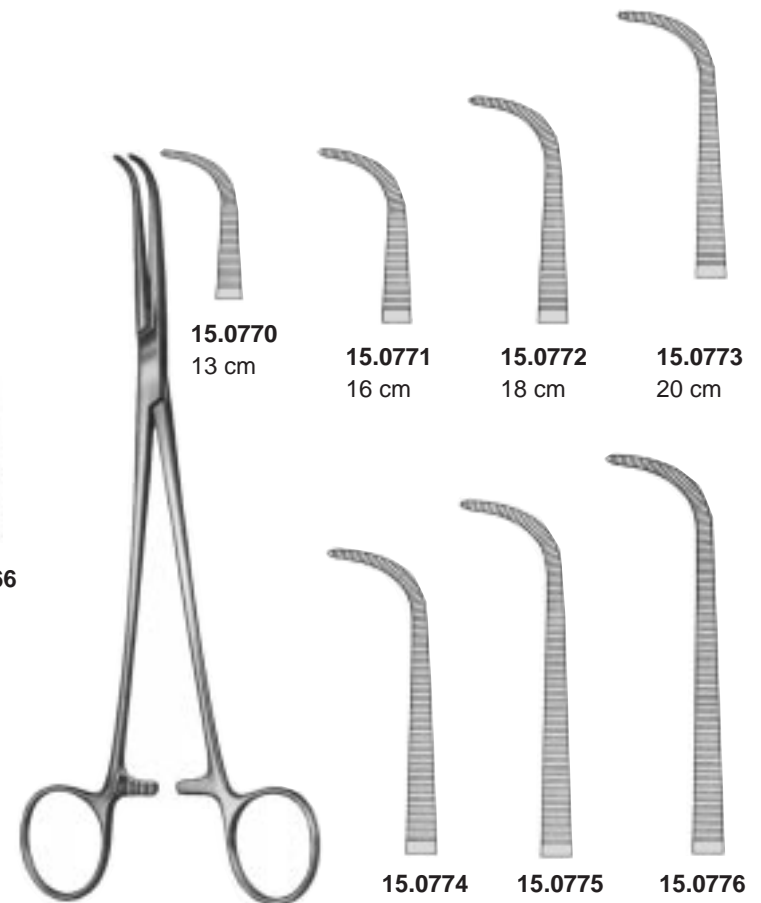

GEMINI



WIKSTROEM
15.0780 21 cm
15.0782 24 cm



LAWRENCE
15.0784 28 cm



MEEKER
15.0786 28 cm



MIXTER-BABY
15.0801 14,5 cm



MIXTER-BABY
15.0803 18 cm

15.0802



MIXTER
 15.0807 22 cm



MIXTER
 15.0809 23 cm



MIXTER

15.0811
 16 cm



15.0813
 19 cm



15.0817
 23 cm



MIXTER

15.0831
 22 cm

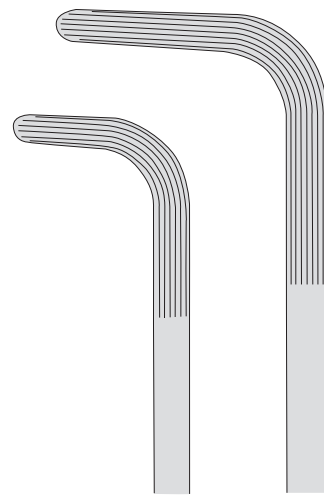

15.0833
 25 cm

15.0835
 28 cm



SCHNIDT
 34.0303
 19 cm



SAWTELL
 34.0305
 19 cm



SCHNIDT
 34.0307
 19 cm



SAWTELL
 34.0309
 19 cm



NEGUS
 19 cm



34.0311



34.0313



WHITE
 34.0321 18 cm
 34.0323 23 cm



34.0330
18,5 cm

BIRKETT



34.0331
18,5 cm



BALLENGER
34.0333
21,5 cm



BLOHMKE
34.0335
20 cm



MARSHIK
34.0350
22 cm



COLVER
19 cm

34.0327



34.0329



HARRINGTON
 40.0701
 30,5 cm



HARRINGTON
 40.0702
 29,5 cm



40.0713
 Zähne links
 teeth on left
 dents à gauche
 dientes a la izquierda
 denti sinistro



40.0714
 Zähne rechts
 teeth on right
 dents à droite
 dientes a la derecha
 denti destro

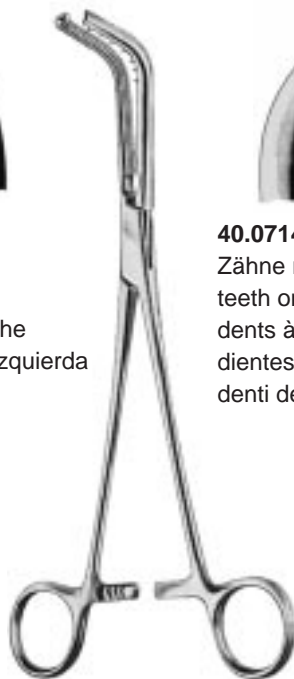

SAROT
 23 cm



FINOCCHIETTO
 40.0720
 24 cm

BRONCHUS- LIGATUR- UND LUNGENFASSZANGEN
 BRONCHUS, LIGATURE, AND LUNG GRASPING FORCEPS
 PINCES DISSECTEURS, À LIGATURES, ET À POUMON
 PINZAS PARA BRONQUIOS, LIGADURAS Y PULMON
 PINZE PER DISSEZIONE, LIGATURE, BRONCHI E PULMONE



PRICE-THOMAS
22 cm

40.0730



PRICE-THOMAS
22 cm

40.0731
Zähne links
teeth on left
dents à gauche
dientes a la izquierda
denti sinistro



40.0732
Zähne rechts
teeth on right
dents à droite
dientes a la derecha
denti destro



BRONCHUS
23 cm



40.0740
60 mm



40.0742
80 mm

BRONCHUS- LIGATUR- UND LUNGENFASSZANGEN
BRONCHUS, LIGATURE, AND LUNG GRASPING FORCEPS
PINCES DISSECTEURS, À LIGATURES, ET À POUMON
PINZAS PARA BRONQUIOS, LIGADURAS Y PULMON
PINZE PER DISSEZIONE, LIGATURE, BRONCHI E PULMONE



LOVELACE
40.0750
20 cm



LOVELACE
40.0751
20 cm



SEMB



40.0761
24 cm #1



40.0763
24 cm #2

BRONCHUS- LIGATUR- UND LUNGENFASSZANGEN
BRONCHUS, LIGATURE, AND LUNG GRASPING FORCEPS
PINCES DISSECTEURS, À LIGATURES, ET À POUMON
PINZAS PARA BRONQUIOS, LIGADURAS Y PULMON
PINZE PER DISSEZIONE, LIGATURE, BRONCHI E PULMONE



SATINSKY
40.0900
15 cm

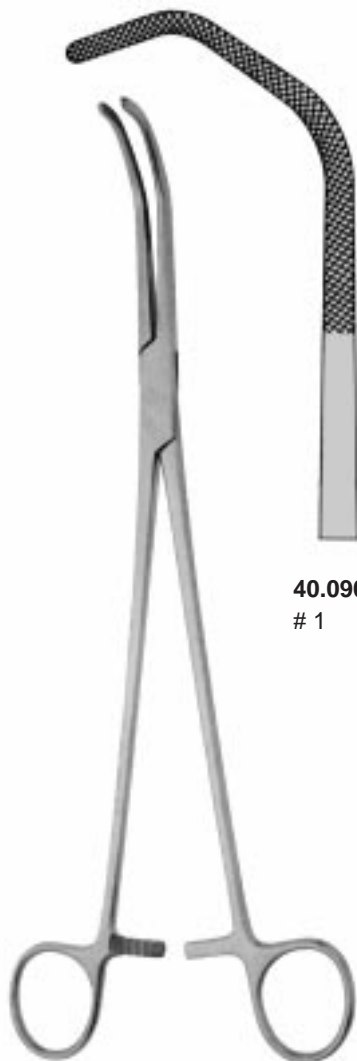

40.0902
1

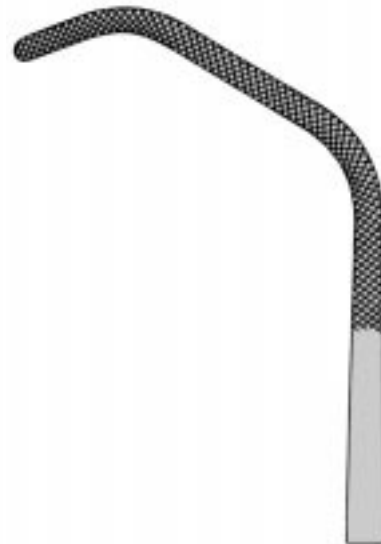

40.0904
2



CHAPUT
 15.1200 12 cm



TUFFIER
 15.1204 13 cm

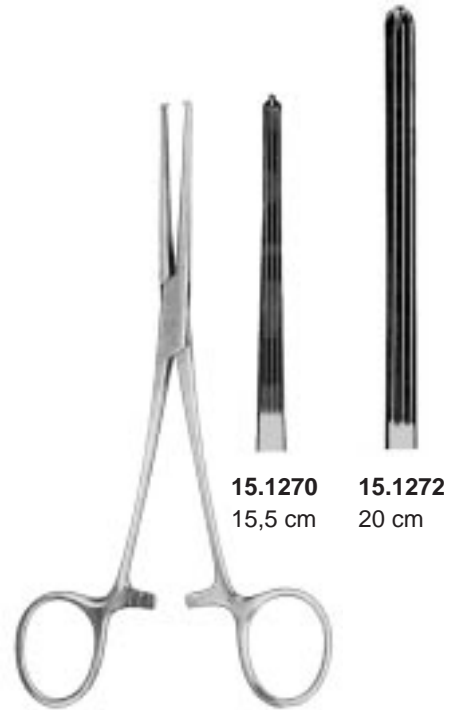

15.1270
 15,5 cm

15.1272
 20 cm

ALLEN-KOCHER



PENNINGTON
 15.1300 15 cm
 15.1302 20 cm



ALLIS-BABY
 48.0004 13 cm, 4 x 5
 48.0006 14 cm, 4 x 5



48.0010
 15 cm, 4 x 5

48.0011
 15 cm, 5 x 6

48.0014
 19 cm, 5 x 6

48.0016
 25 cm, 5 x 6

ALLIS

GEWEBE- UND ORGANFASSZANGEN
 TISSUE AND ORGAN HOLDING FORCEPS
 PINCES À PREHENSION
 PINZAS PARA TEJIDOS Y ORGANOS
 PINZE PER AFFERARE TESSUTI E ORGANI

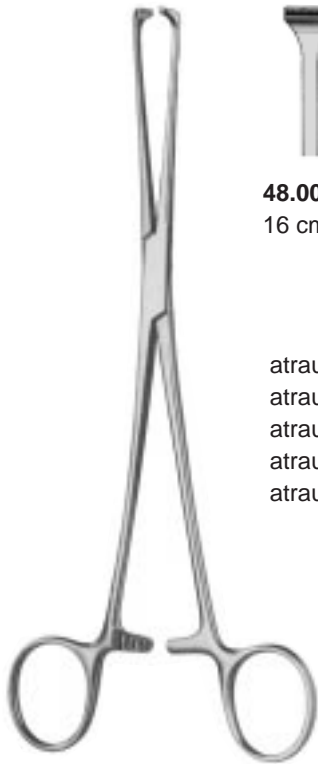

ALLIS

48.0020
16 cm

atraumatisch
 atraumatic
 atraumatique
 traumática
 atraumatiche

48.0024
20 cm

48.0028
25 cm

48.0029
30 cm



ALLIS-ADAIR
48.0030 15,5 cm



JUDD-ALLIS
48.0032 15 cm
48.0034 19 cm
3 x 4



LITTLEWOOD
48.0035 19 cm
2 x 3



BOYS-ALLIS
48.0036 15 cm



THOMS-ALLIS
48.0038 20 cm
6 x 7



LOCKWOOD
48.0040 19,5 cm



OMBREDANNE
48.0050 13,5 cm



WILLIAMS
48.0045 16,5 cm



BABCOCK



48.0062
16 cm



48.0064
18 cm



48.0066
20 cm



48.0068
24 cm



BABCOCK



48.0072
16 cm



48.0076
20 cm

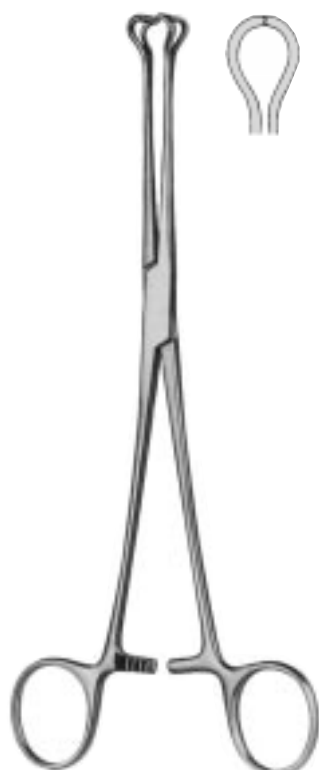

BABCOCK-DEBAKEY



48.0082
16 cm



48.0086
20 cm



48.0088
23 cm



COLLIN
 48.0089
 14 cm



DUVAL



48.0090
 18 cm / 14 mm
48.0092
 20 cm / 14 mm



48.0094
 20 cm / 25 mm
48.0098
 23 cm / 25 mm



48.0094 AT
 20 cm / 20 mm
48.0098 AT
 23 cm / 25 mm

atraumatisch
 atraumatic
 atraumatique
 atraumática
 atraumatiche



DUVAL



48.0099
 20 cm / 15 mm





15.1580
25 cm



DEBAKEY



15.1582
27 cm



PRATT
15.1350 15 cm



KOCHER-BABY
13 cm

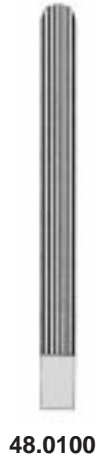

48.0100



48.0101

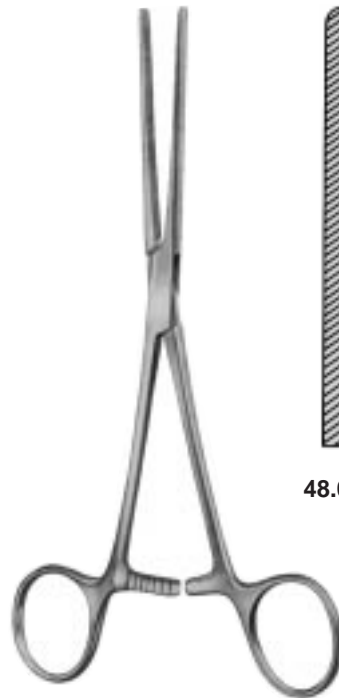

DOYEN
18 cm

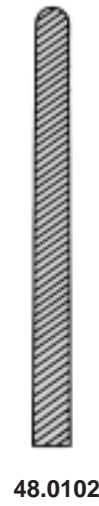

48.0102



48.0103



DOYEN



48.0104 21 cm
48.0106 23 cm



48.0105 21 cm
48.0107 23 cm

DARMKLEMMEN
INTESTINAL CLAMP FORCEPS
PINCES-CLAMPS POUR L'INTESTIN
PINZAS-CLAMPS INTESTINALES
PINZE INTESTINALI

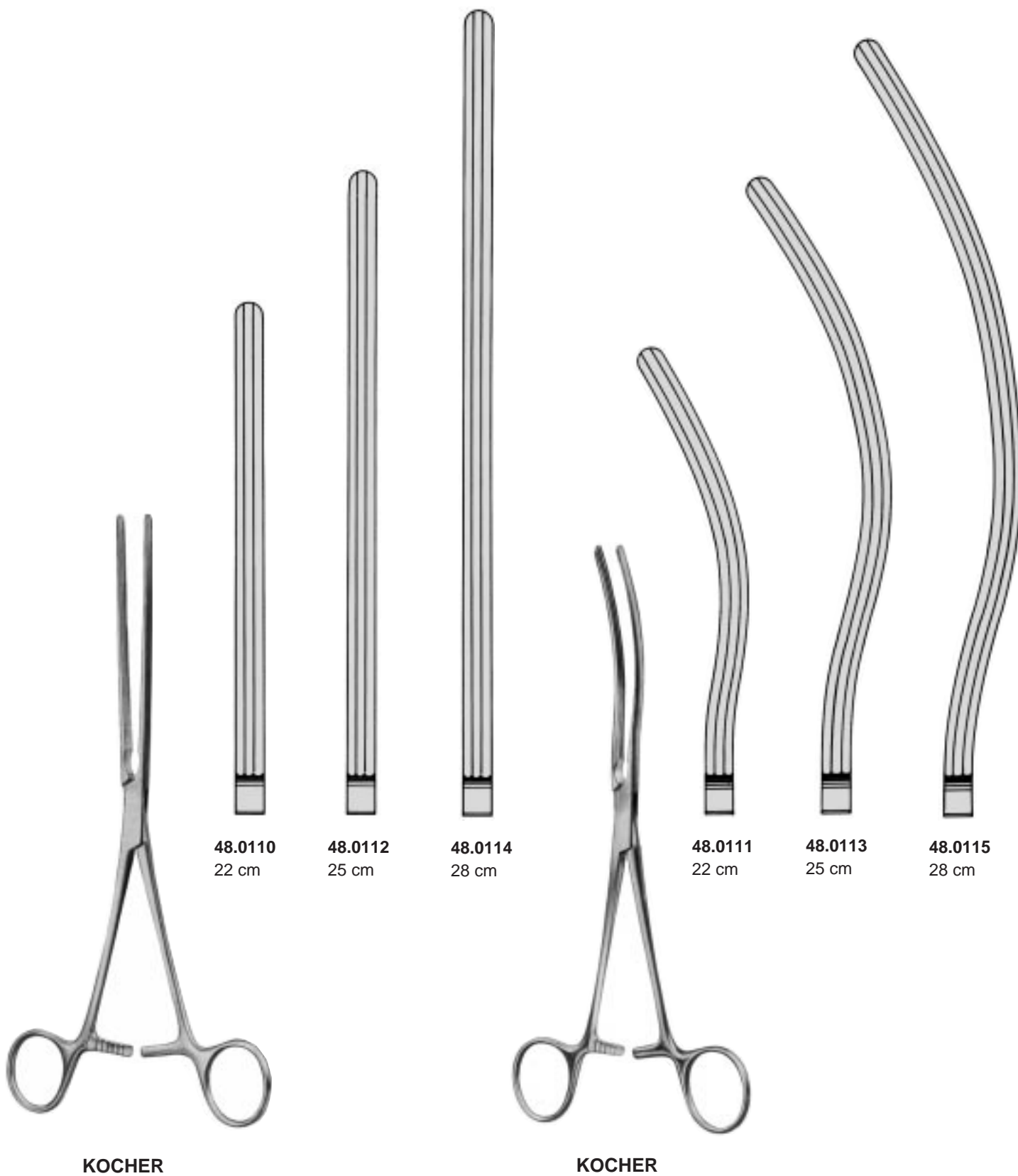

KOCHER

KOCHER

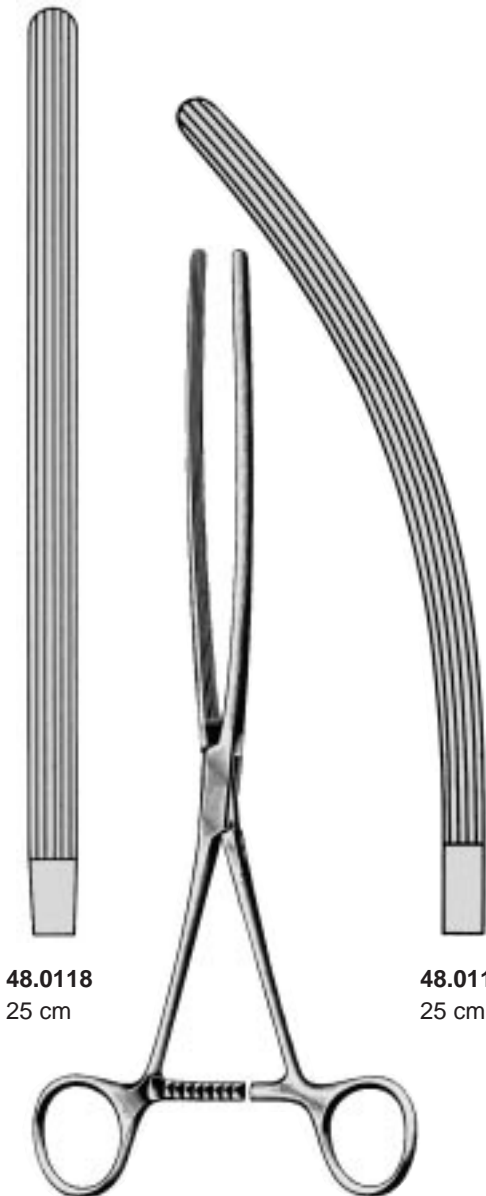

48.0118
25 cm

48.0119
25 cm

MAYO-ROBSON

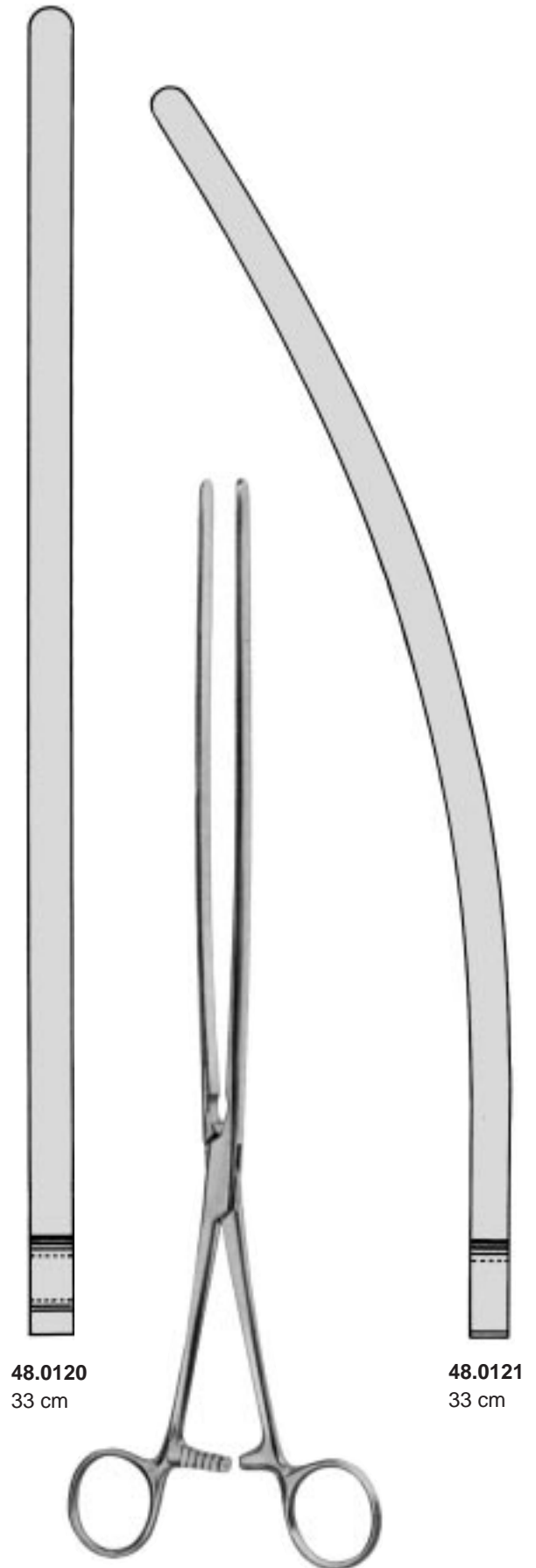

48.0120
33 cm

48.0121
33 cm

SCUDDER

DARMKLEMMEN
INTESTINAL CLAMP FORCEPS
PINCES-CLAMPS POUR L'INTESTIN
PINZAS-CLAMPS INTESTINALES
PINZE INTESTINALI

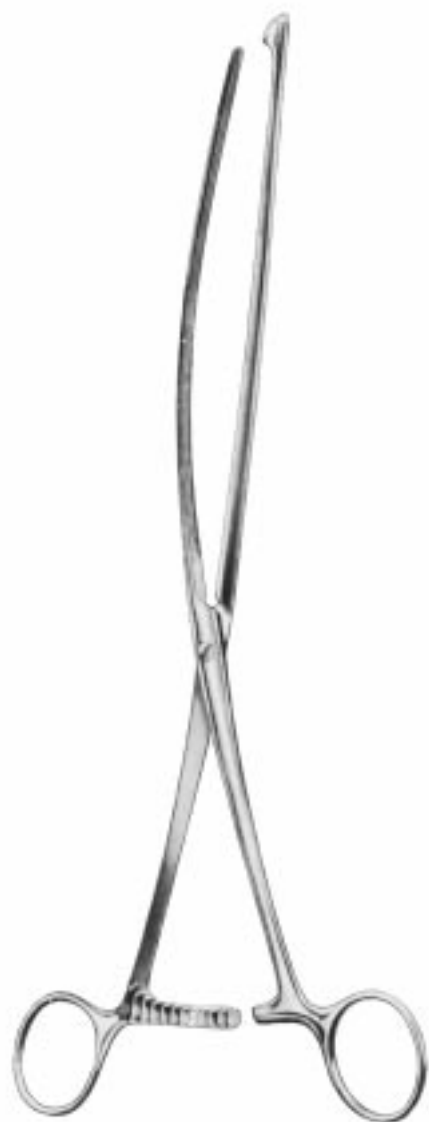

NUSSBAUM
25 cm

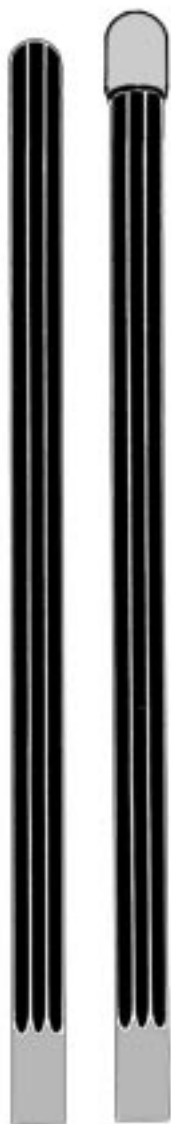

48.0122



48.0123



BRUNNER
48.0125 23 cm

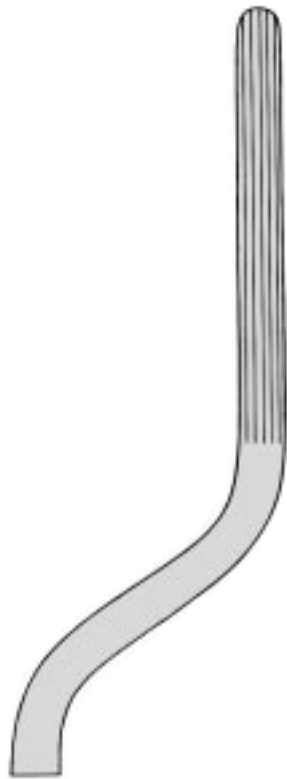

FEHLAND
48.0126 24 cm



48.0130
26,5 cm / 30 mm



48.0131
26,5 cm / 60 mm



48.0132
26,5 cm / 75 mm



BEST

DARMKLEMMEN
INTESTINAL CLAMP FORCEPS
PINCES-CLAMPS POUR L'INTESTIN
PINZAS-CLAMPS INTESTINALES
PINZE INTESTINALI



LANE
48.0140 30 cm



LANE
48.0141 30 cm

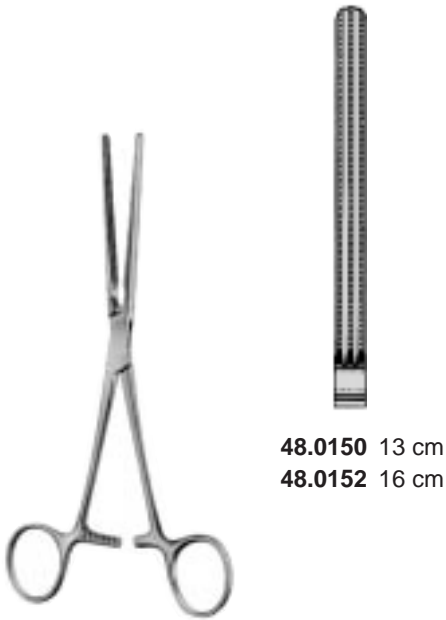

48.0150 13 cm
 48.0152 16 cm

DOYEN-DEBAKEY



48.0151 13 cm
 48.0153 16 cm

DOYEN-DEBAKEY

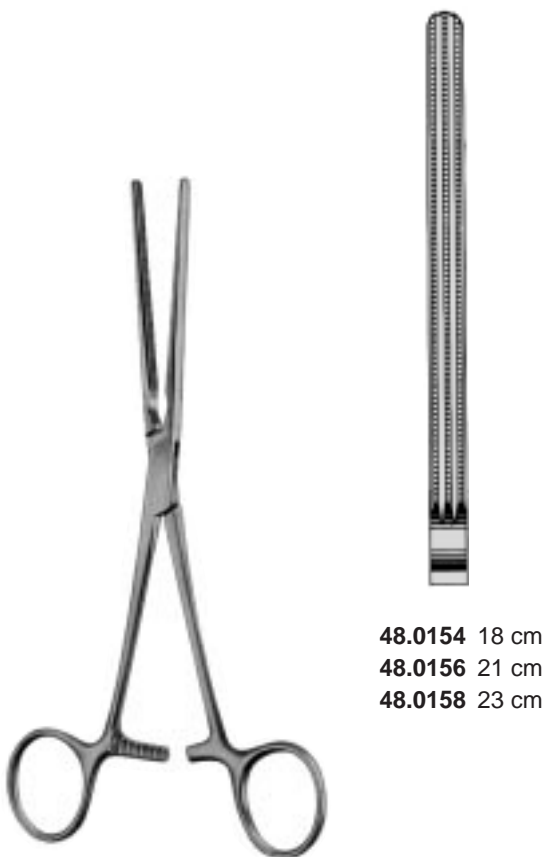

48.0154 18 cm
 48.0156 21 cm
 48.0158 23 cm

DOYEN-DEBAKEY



48.0155 18 cm
 48.0157 21 cm
 48.0159 23 cm

DOYEN-DEBAKEY

DARMKLEMMEN
INTESTINAL CLAMP FORCEPS
PINCES-CLAMPS POUR L'INTESTIN
PINZAS-CLAMPS INTESTINALES
PINZE INTESTINALI



KOCHER-DEBAKEY

48.0160 22 cm
48.0162 25 cm
48.0164 28 cm



KOCHER-DEBAKEY

48.0161 22 cm
48.0163 25 cm
48.0165 28 cm



HAYES-DEBAKEY



48.0170
26 cm / 55 mm

48.0172
28 cm / 85 mm



FEHLANT-DEBAKEY
48.0180 24 cm

DARMKLEMMEN
INTESTINAL CLAMP FORCEPS
PINCES-CLAMPS POUR L'INTESTIN
PINZAS-CLAMPS INTESTINALES
PINZE INTESTINALI

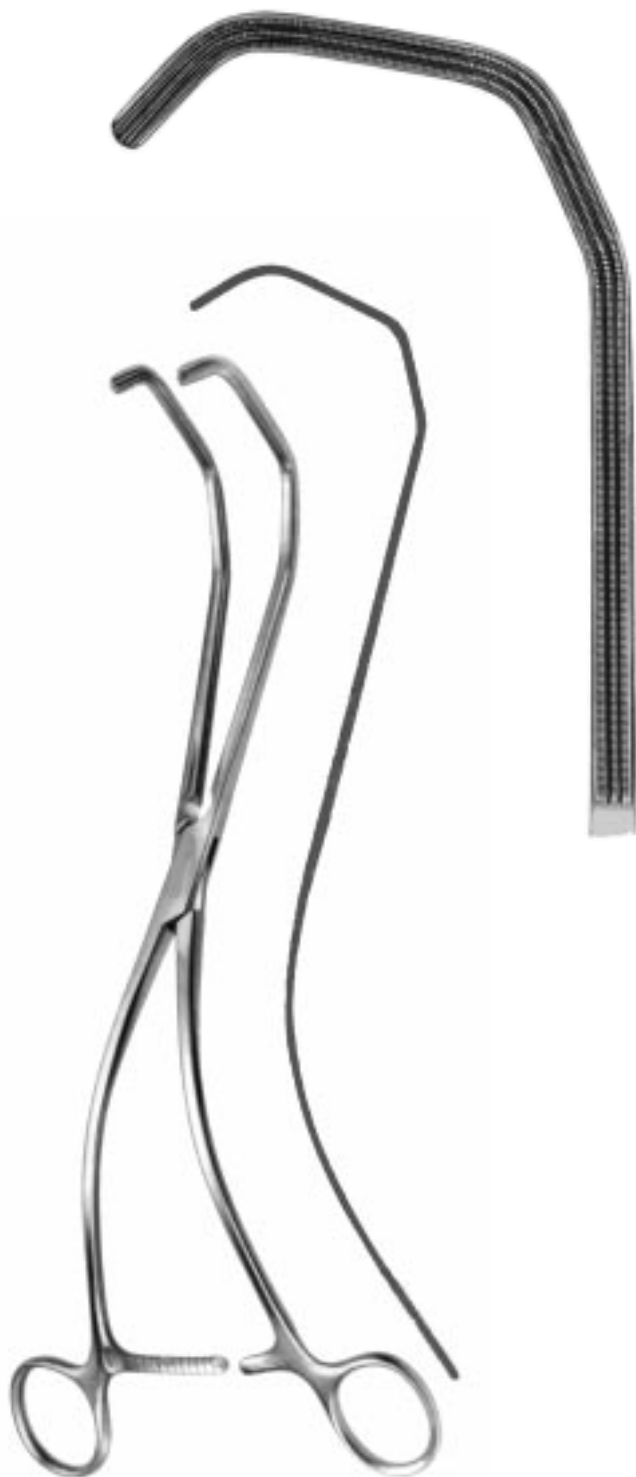

KERSTING
48.0184
31 cm

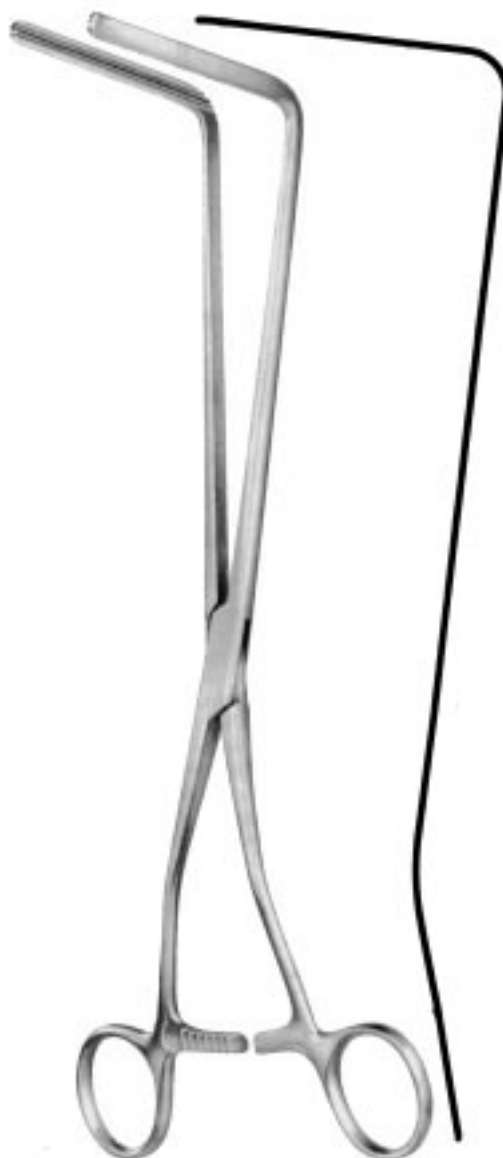

RESANO
48.0186
30 cm



SCUDDER-DEBAKEY
48.0190
33 cm



SCUDDER-DEBAKEY
48.0191
33 cm

DARMKLEMMEN
INTESTINAL CLAMP FORCEPS
PINCES-CLAMPS POUR L'INTESTIN
PINZAS-CLAMPS INTESTINALES
PINZE INTESTINALI



48.0200
25 cm 0°



48.0204
28 cm 0°



48.0201
25 cm 15°



48.0205
28 cm 15°

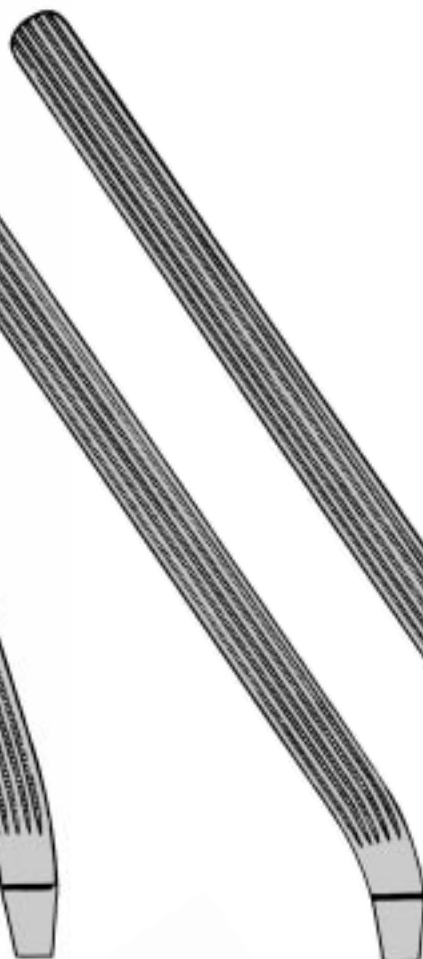

48.0203
25 cm 30°



48.0207
28 cm 30°

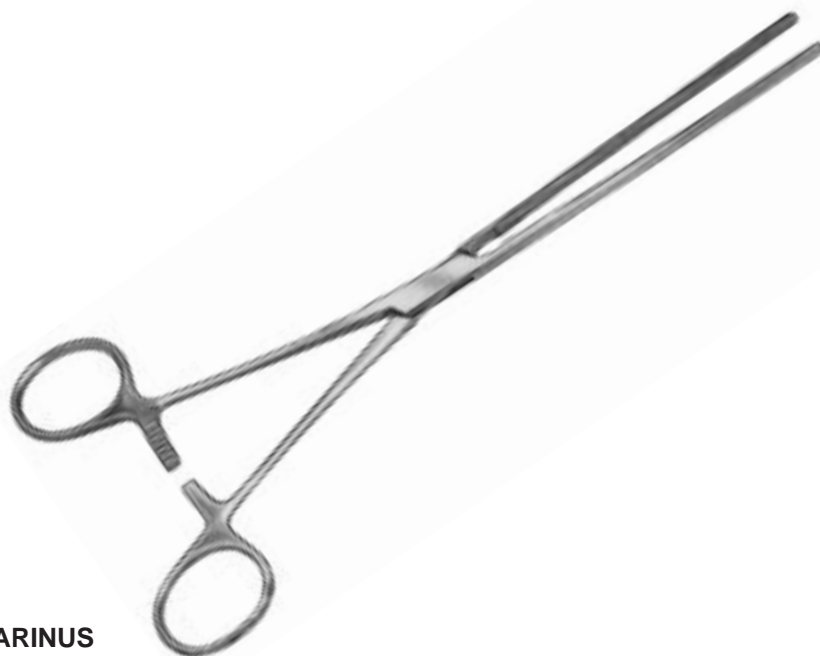

MARINUS



BUIE
48.0300 21 cm



LLOYD-DAVIES
48.0350 31,5 cm



FERGUSSON

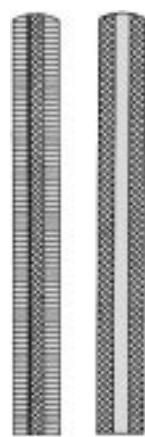

48.0312 20 cm

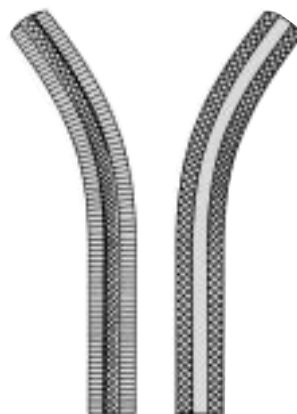

48.0313 20 cm

GALLENKANALKLEMMEN
GALL DUCT FORCEPS
PINCES POUR LE CANAL CHOLEDOQUE
PINZAS PARA CONDUCTO BILIAR
PINZE PER IL CONDOTTO BILIARE



LAHEY
15.0841 19 cm
15.0843 23 cm



MOYNIHAN
15.0901 23 cm
15.0903 24 cm



DESJARDIN
15.0911 21 cm



DESJARDIN
15.0913 21 cm

GALLENKANALKLEMMEN
 GALL DUCT FORCEPS
 PINCES POUR LE CANAL CHOLEDOQUE
 PINZAS PARA CONDUCTO BILIAR
 PINZE PER IL CONDOTTO BILIARE



LOWER
 15.0931 18 cm



JOHNS-HOPKINS
 15.0941 20 cm



MIXTER
 15.1015 22 cm



GRAY
 15.1031 22 cm #1



15.1033
 23 cm #2



GRAY
 15.1035 22 cm #1



15.1037
 23 cm #2

GALLENSTEINZANGEN
GALL STONE FORCEPS
PINCES POUR CALCULS BILAIRES
PINZAS PARA CALCULOS BILIARES
PINZE PER CALCOLI BILIARI



BLAKE
20 cm



50.0300



50.0301



DESJARDINS
23 cm



50.0311
#1



50.0313
#2



DESJARDINS



50.0315
24 cm



50.0317
22,5 cm



MAYO-BLAKE
50.0320
20 cm



MAYO-BLAKE
50.0321
20 cm



MIXTER
50.0325
22 cm



DOYEN
50.0330
20 cm

NIERENSTIELKLEMMEN
KIDNEY CLAMPS
PINCES CLAMPS RENALES
PINZAS CLAMPS RENALES
PINZE CLAMPS RENALI



MAYO-GUYON
 15.1930 23 cm



GUYON

15.1931
 20 cm



15.1933
 22 cm



15.1935
 24 cm



GUYON
 15.1937 23 cm



STILLE
 15.1940 23 cm



HERRICK
 15.1960 23 cm



50.0340
 23 cm #1



50.0342
 21 cm #2



50.0344
 19 cm #3



1



2



50.0346
 18 cm #4

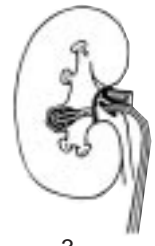

3

RANDALL

50.0347

Satz #1-4 / Set #1-4 /

Jeu #1-4 / Juego #1-4 / Serie di #1-4



RANDALL

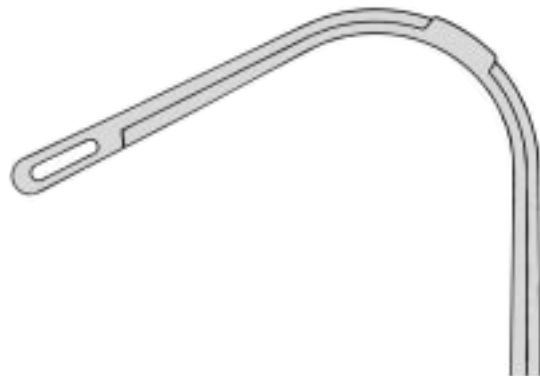

50.0348
 19 cm #5



4



50.0350
 19 cm #6



5 / 6



50.0401
1



50.0402
2

URO

24 cm

Ureterzangen
Ureter Forceps
Pincés pour urètre
Pinzas para uréter
Pinze per uretere



DARTIGUES

55.1520

27 cm

Nierenfaßzange
Kidney elevating forceps
Hystérolabe
Pinza para sostener el riñón
Pinze per afferare il rene

Prostata-Fasszange
Prostatic grasping forceps
Pince à saisir la prostate
Pinza para coger prostata
Pinza per afferare la prostata



YOUNG
51.0004
20 cm

Samenstrang-Fixierklemme
Spermatic cord fixation clamp
Pince pour fixer le canal déférent
Pinza-fixajion canal espermatica
Pinza per fissare il tronco spermatico



SPERMATIC
51.0040
14,5 cm

Ureterklemmen
Ureter clamps
Pinces à urètere
Pinzas clamps para ureter
Pinze per uretere



51.0042
21 cm #2

LURZ
51.0041
21 cm #1

PERITONEUMKLEMMEN
 PERITONEUM FORCEPS
 PINCES A PERITOINE
 PINZAS PER PERITONEO
 PINZE PER PERITONEO



WERTHEIM
 15.2125
 24 cm 1x2



15.2200
 18 cm

15.2202
 20 cm



15.2209
 20 cm

15.2211
 20 cm



MIKULICZ-BABY
 15.2215 14 cm



15.2221

15.2223

FAURE
 20 cm



FAURE
 15.2225 25 cm



PHANEUF

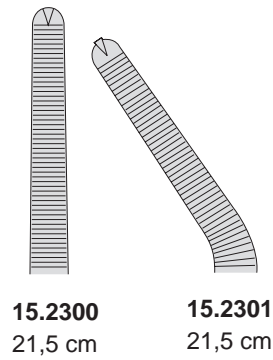

15.2300
21,5 cm

15.2301
21,5 cm

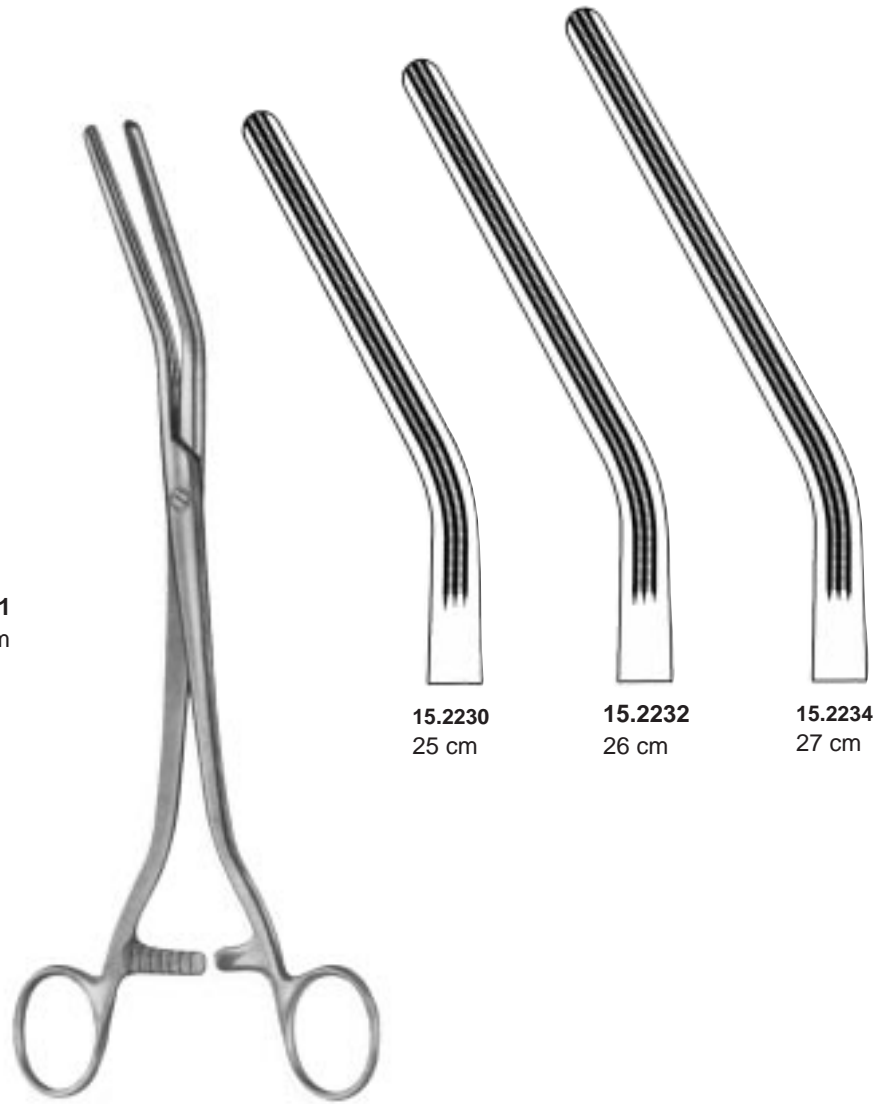

DICK

Druckklemmen
Pressure Clamps
Pinces à pression
Pinzas de presión
Pinze de pressione

15.2230
25 cm

15.2232
26 cm

15.2234
27 cm

HYSTEREKTOMIEKLEMMEN
HYSTERECTOMY FORCEPS
PINCES A HYSTERECTOMIE
PINZAS PARA HISTERECTOMIA
PINZE PER ISTERECTOMIA



HEANEY-KANTOR

15.2311 20 cm

15.2313 23 cm



HEANEY-REZEK

15.2314 23 cm



HEANEY

15.2315 20 cm

15.2317 23 cm



WERTHEIM

15.2321 25 cm



**SECOND-
LANDAU**

15.2324

24 cm



SECOND

15.2325

24 cm



WERTHEIM-CULLEN
15.2340 21,5 cm



WERTHEIM-ATRAUMA
15.2344 21 cm

atraumatisch
atraumatic
atraumatique
atraumática
atraumatiche

HYSTEREKTOMIEKLEMMEN
HYSTERECTOMY FORCEPS
PINCES A HYSTERECTOMIE
PINZAS PARA HISTERECTOMIA
PINZE PER ISTERECTOMIA



15.2345
22 cm
1x2

WERTHEIM



15.2347
22 cm
1x2

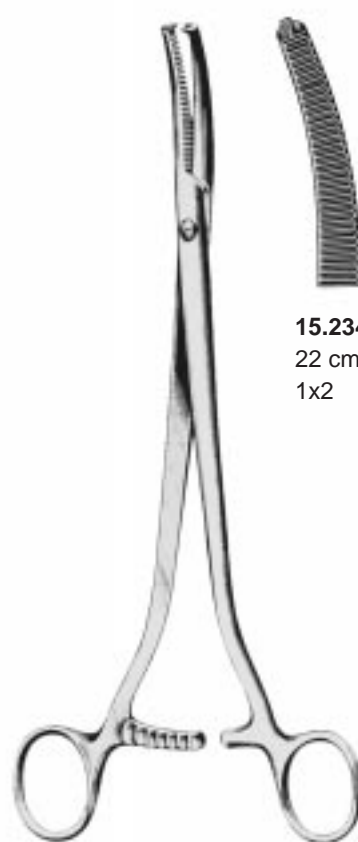

15.2348
22 cm
1x2

WERTHEIM



15.2349
22 cm
1x2



15.2360
22 cm



15.2361
22 cm



15.2362
21 cm



15.2363
20 cm



WERTHEIM-DEBAKEY



15.2365
25 cm



15.2366
25 cm



15.2367
25 cm



15.2368
24 cm

HAKENZANGEN

TENACULUM FORCEPS

PINCES POUR ABAISSEMENT DU COL UTERIN

PINZAS PARA COGER EL CUELLO DEL UTERO

PINZE PER ABBASSARE EL COLLO DELL'UTERO



BARRETT
55.0930
18 cm



STAUDE-MOORE
55.0932
17 cm



BRAUN
55.0934
25 cm



CZERNY
55.0936
21 cm



ADAIR
55.0938
19 cm



SCHROEDER
55.0940
25 cm



POZZI
55.0944
25 cm

HAKENZANGEN
TENACULUM FORCEPS
PINCES POUR ABAISSEMENT DU COL UTERIN
PINZAS PARA COGER EL CUELLO DEL UTERO
PINZE PER ABBASSARE EL COLLO DELL'UTERO



DUPLAY
55.0947
28 cm



HULKA
55.0948
29 cm



HULKA-KENWICK
55.0949
29 cm



SKENE
55.0951
24 cm



TIEMANN
55.0956
22 cm

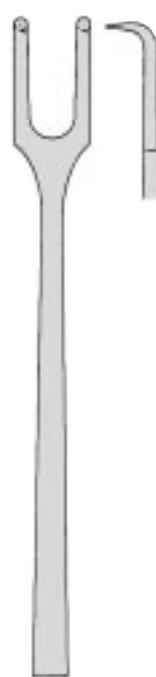

55.0962
2 x 2



55.0963
2 x 2



SCHROEDER
24 cm

HAKENZANGEN
TENACULUM FORCEPS
PINCES POUR ABAISSEMENT DU COL UTERIN
PINZAS PARA COGER EL CUELLO DEL UTERO
PINZE PER ABBASSARE EL COLLO DELL'UTERO

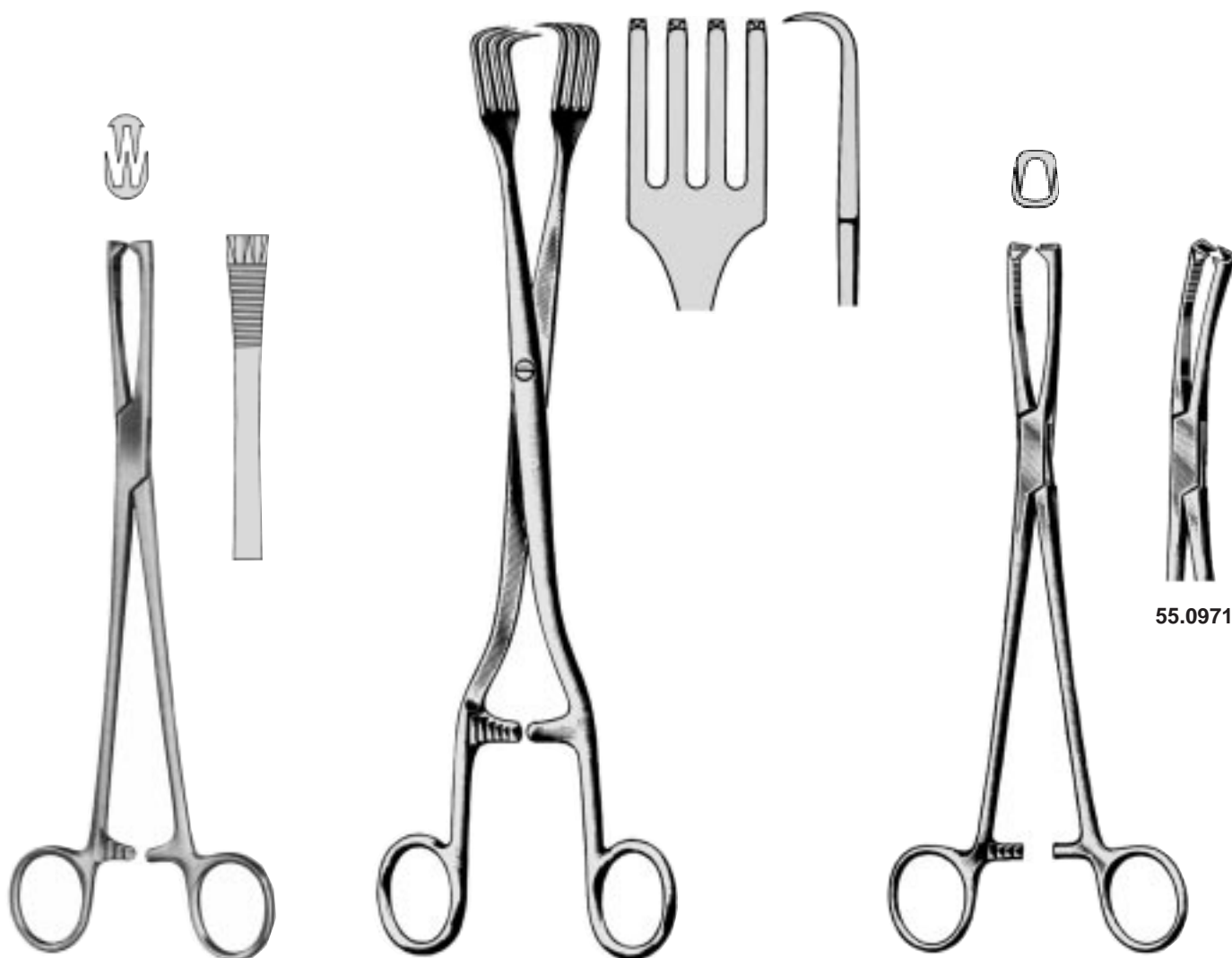

HENROTIN
55.0965
21 cm 2 x 3

PRATT
55.0968
28 cm

JACOBS
55.0970
21 cm

HAKENZANGEN
 TENACULUM FORCEPS
 PINCES POUR ABAISSEMENT DU COL UTERIN
 PINZAS PARA COGER EL CUELLO DEL UTERO
 PINZE PER ABBASSARE EL COLLO DELL'UTERO



TEALE

55.0973 18 cm 3 x 4
 55.0975 23 cm 3 x 4



KÜSTNER

55.0977 25 cm 2 x 3



MUSEUX

55.0980 24 cm / 6 mm
 55.0982 24 cm / 8 mm
 55.0984 24 cm / 10 mm



6 mm

8 mm

10 mm

55.0981 24 cm / 6 mm
 55.0983 24 cm / 8 mm

UTERUS-FASSZANGEN
UTERINE ELEVATING FORCEPS
PINCES HYSTEOLLABES
PINZAS PARA EL UTERO
PINZE PER AFFERRARE L'UTERO



SOMER
55.1500
23 cm



COLLIN
551510
25 cm



COLLIN
55.1511
25 cm



DARTIGUES
55.1520
27 cm

KLEMM-, PLAZENTAR-, UND ABORTUSZANGEN
HEMOSTATIC, PLACENTA, AND OVUM FORCEPS
PINCES HÉMOSTATIQUES ET À FAUX GERMES
PINZAS HEMOSTATICAS, PARA ABORTO Y PLACENTA
PINZE PER AMNIOSCOPIA, PLACENTA E ABORTO

Klemmzange / Uterine Hémostatic Forceps /
Pince-Clamp utérine / Pinza-Clamp uterina / Pinza-Clamp uterina



GREEN-ARMYTAGE
56.0800 22 cm



GREEN-ARMYTAGE
56.0801 20 cm

Kopfschwartzangen / Scalp flap forceps / Pincés pour le
quir chevelu / Pinzas para pericráneo / Pinze per pericráneo

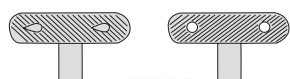

MARTEL
15.1340 14 cm



WILLET
15.1342 19 cm



GAUSS
56.0805 26 cm

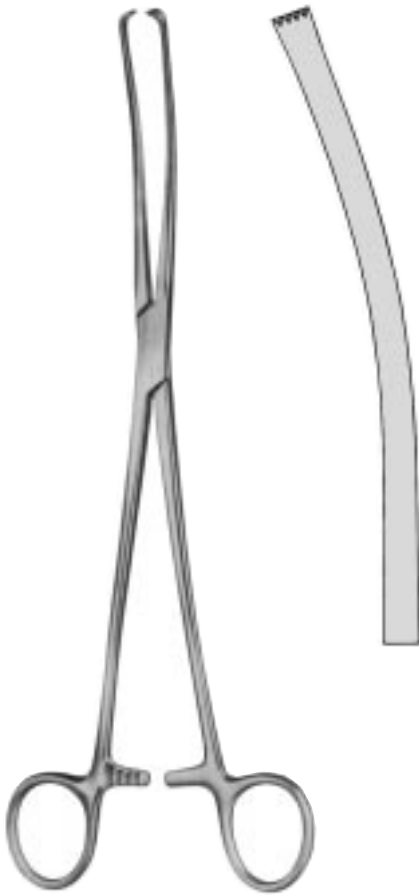

Blasensprenger /
Membrane puncturing forceps /
Pince perce-membrane /
Pinza rompe membrana /
Pinza rompere membrana

IOWA
56.0820 26 cm

Uterus-Polymenzangen / Uterine Polypus Forceps /
Pinces à polypes utérines / Pinzas para pólipos uterinos /
Pinze per polipi uterini



HEYWOOD-SMITH
56.0880 21 cm
56.0882 25 cm



DOYEN
56.0890 20 cm

Uterus-Polymenzangen / Uterine Polypus Forceps /
Pincés à polypes utérines / Pinzas para pólipos uterinos /
Pinze per polipi uterini



NOTO
56.0896 27 cm



BUMM
56.0898 28 cm

KLEMM-, PLAZENTAR-, UND ABORTUSZANGEN
 HEMOSTATIC, PLACENTA, AND OVUM FORCEPS
 PINCES HÉMOSTATIQUES ET À FAUX GERMES
 PINZAS HEMOSTATICAS, PARA ABORTO Y PLACENTA
 PINZE PER AMNIOSCOPIA, PLACENTA E ABORTO

Plazentar- und Abortuszangen / Placenta- and Ovum Forceps / Pincers à faux germes /
 Pinzas para aborto y placenta / Pinze per aborto e placenta



KELLY
 56.0900 32 cm

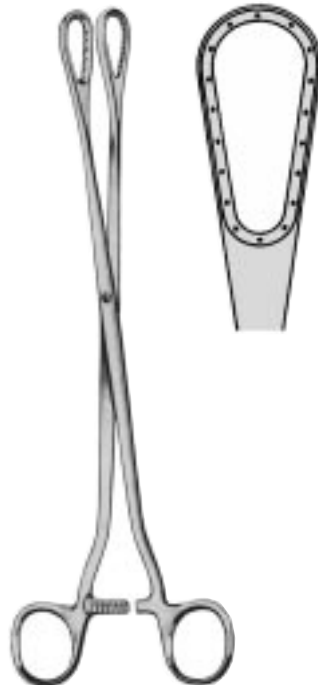

SAENGER
 56.0910 27 cm

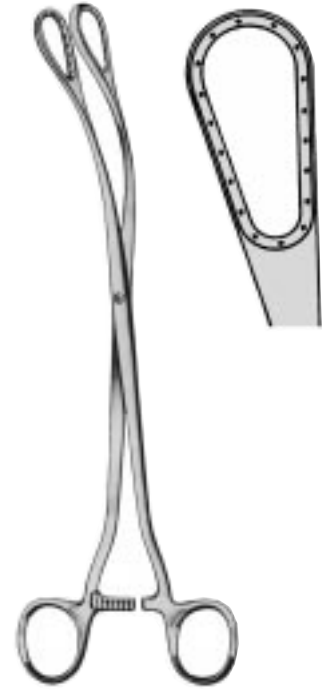

SAENGER
 56.0911 27 cm



WINTER
 29 cm



56.1000
 #1



56.1002
 #2



56.1004
 #3



WINTER
 29 cm



56.1001
 #1



56.1003
 #2



56.1005
 #3

