

GEFÄSSKLEMMEN
CARDIOVASCULAR CLAMPS
PINCES VASCULAIRES
PINZAS VASCULARES
PINZE VASCOLARI



GEFÄSSKLEMMEN FÜR KINDER UND NEUGEBORENE
PEDIATRIC- AND NEONATAL VASCULAR CLAMPS
PINCES VASCULAIRES PÉDIATRIQUES ET POUR NOUVEAUX NÉS
PINZAS VASCULARES PEDIÁTRICAS Y PARA RACIEN NACIDOS
PINZE VASCOLARI PEDIATRICE E NEONATALI

ULTRAFINO Gefäßklemmen für Kinder und Neugeborene
ULTRAFINO Pediatric- and Neonatal Vascular Clamps
ULTRAFINO Pincers vasculaires pédiatriques et pour nouveaux nés
ULTRAFINO Pinzas vasculares pediátricas y para recién nacidos
ULTRAFINO Pinze vascolari pediatriche e per neonati

Stainless Steel **T=Titanium**

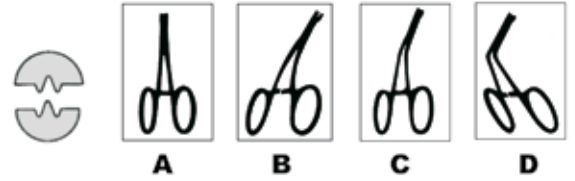

	1	2	3	4	5	6						
A	40.1921	40.1921T	40.1922	40.1922T	40.1923	40.1923T	40.1924	40.1924T	40.1925	40.1925T	40.1926	40.1926T
B	40.1941	40.1941T	40.1942	40.1942T	40.1943	40.1943T	40.1944	40.1944T	40.1945	40.1945T	40.1946	40.1946T
C	40.1961	40.1961T	40.1962	40.1962T	40.1963	40.1963T	40.1964	40.1964T	40.1965	40.1965T	40.1966	40.1966T
D	40.1981	40.1981T	40.1982	40.1982T	40.1983	40.1983T	40.1984	40.1984T	40.1985	40.1985T	40.1986	40.1986T

	7	8	9	10	11	12						
A	40.1927	40.1927T	40.1928	40.1928T	40.1929	40.1929T	40.1930	40.1930T	40.1931	40.1931T	40.1932	40.1932T
B	40.1947	40.1947T	40.1948	40.1948T	40.1949	40.1949T	40.1950	40.1950T	40.1951	40.1951T	40.1952	40.1952T
C	40.1967	40.1967T	40.1968	40.1968T	40.1969	40.1969T	40.1970	40.1970T	40.1971	40.1971T	40.1972	40.1972T
D	40.1987	40.1987T	40.1988	40.1988T								

	13	14	15	16	17	18						
A	40.1933	40.1933T	40.1934	40.1934T	40.1935	40.1935T	40.1936	40.1936T	40.1937	40.1937T	40.1938	40.1938T
B	40.1953	40.1953T	40.1954	40.1954T	40.1955	40.1955T	40.1956	40.1956T	40.1957	40.1957T	40.1958	40.1958T
C	40.1973	40.1973T	40.1974	40.1974T	40.1975	40.1975T	40.1976	40.1976T	40.1977	40.1977T	40.1978	40.1978T

GEFÄSSKLEMMEN FÜR KINDER UND NEUGEBORENE
 PEDIATRIC- AND NEONATAL VASCULAR CLAMPS
 PINCES VASCULAIRES PEDIATRQUES ET POUR NOUVEAUX NES
 PINZAS VASCULARES PEDIATRICAS Y PARA RACIEN NACIDOS
 PINZE VASCOLARI PEDIATRICE E NEONATALI

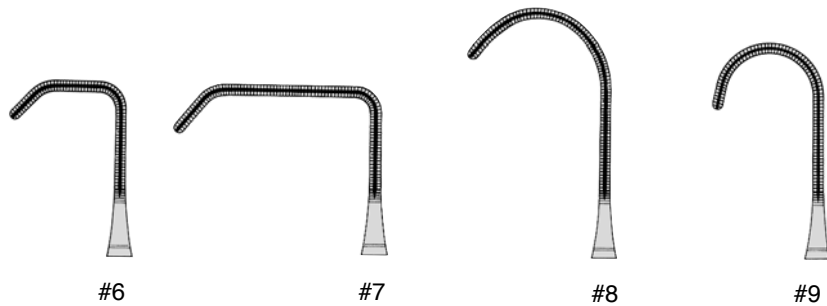
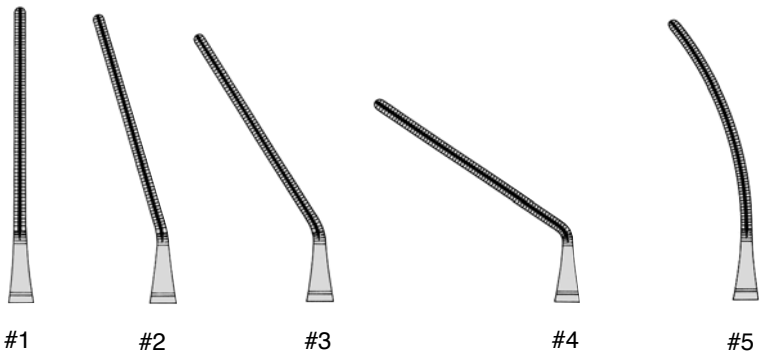

gerade
 straight
 droit
 recto
 retto

DEBAKEY-CASTANEDA

- 40.2001 14,5 cm #1
- 40.2002 14,5 cm #2
- 40.2003 14,5 cm #3
- 40.2004 13,5 cm #4
- 40.2005 14 cm #5
- 40.2006 13,5 cm #6
- 40.2007 13,5 cm #7
- 40.2008 14 cm #8
- 40.2009 13,5 cm #9



abgewinkelt
 angled
 angulaires
 angulares
 angolate

DEBAKEY-CASTANEDA

- 40.2021 14,5 cm #1
- 40.2022 14,5 cm #2
- 40.2023 14,5 cm #3
- 40.2024 13,5 cm #4
- 40.2025 14 cm #5
- 40.2026 13,5 cm #6
- 40.2027 13,5 cm #7
- 40.2028 14 cm #8
- 40.2029 13,5 cm #9

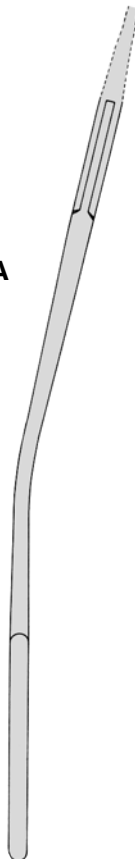

gebogen
 curved
 courbe
 curvo
 curvo

DEBAKEY-CASTANEDA

- 40.2041 14 cm #1
- 40.2042 14 cm #2
- 40.2043 14 cm #3
- 40.2044 13 cm #4
- 40.2045 14 cm #5
- 40.2046 13 cm #6
- 40.2047 13 cm #7
- 40.2048 14 cm #8
- 40.2049 13 cm #9

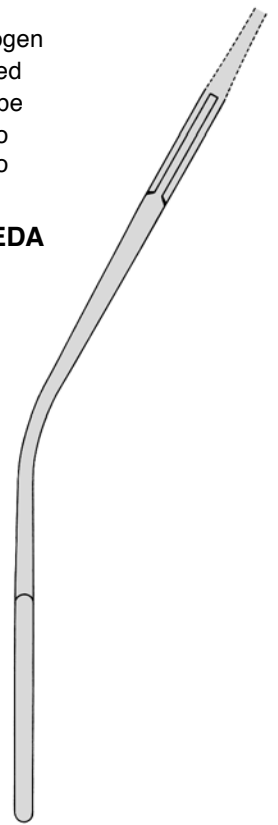

GEFÄSSKLEMMEN FÜR KINDER UND NEUGEBORENE
PEDIATRIC- AND NEONATAL VASCULAR CLAMPS
PINCES VASCULAIRES PEDIATRIQUES ET POUR NOUVEAUX NES
PINZAS VASCULARES PEDIATRICAS Y PARA RACIEN NACIDOS
PINZE VASCOLARI PEDIATRICE E NEONATALI

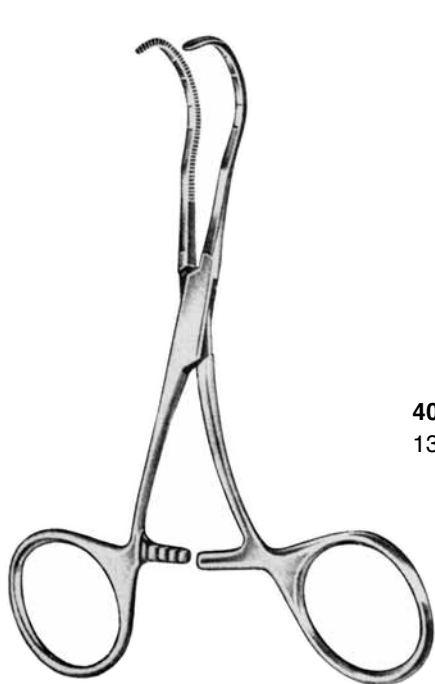

CASTANEDA



40.2130
13 cm

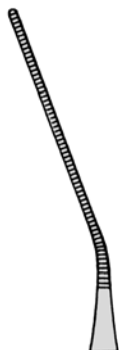

40.2133
13 cm
30°



40.2135
12 cm
45°



40.2137
11 cm
75°



40.2139
11 cm
90°

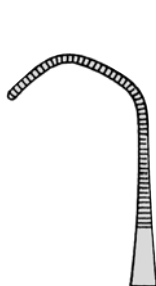

40.2140
15 cm



40.2141
12 cm

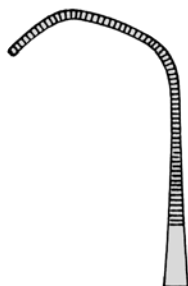

40.2142
15 cm



40.2145
12 cm

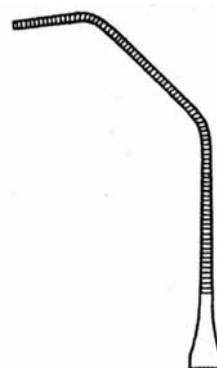

40.2146
15 cm



40.2147
15 cm

Anastomosenklemmen
 Anastomosis clamps
 Pincès à anastomoses
 Pinzas para anastomosis
 Pinze per anastomosi



COOLEY-DERRA
 17 cm

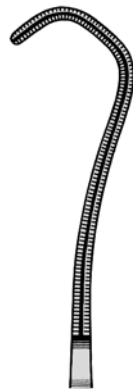

40.0901
 #1

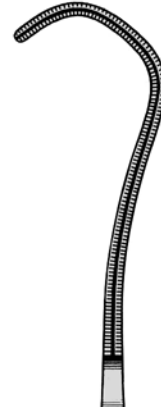

40.0905
 #2

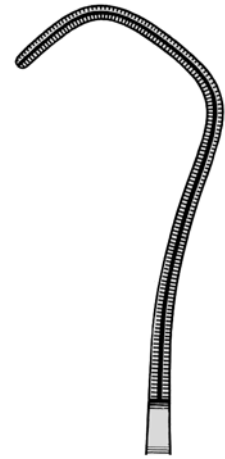

40.0910
 #3

Mehrzweckklemmen
 Multipurpose clamps
 Pincès polyvalents
 Pinzas para múltiples aplicaciones
 Pinze per vari applicazioni

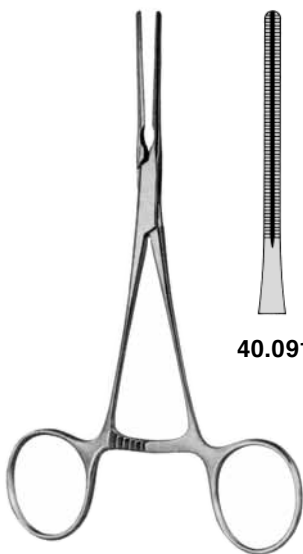

COOLEY
 14 cm

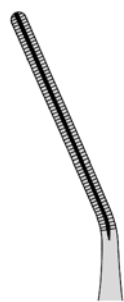

40.0911

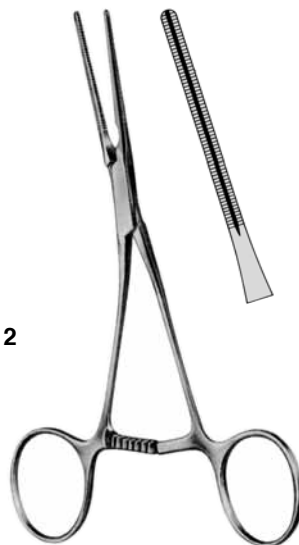

COOLEY
40.0913
 14 cm

40.0912
 30°



COOLEY
40.0914
 14 cm



COOLEY-SATINSKY
40.0915
 14 cm

**GEFÄSSKLEMMEN FÜR KINDER UND NEUGEBORENE
PEDIATRIC- AND NEONATAL VASCULAR CLAMPS
PINCES VASCULAIRES PEDIATRIQUES ET POUR NOUVEAUX NES
PINZAS VASCULARES PEDIATRICAS Y PARA RACIEN NACIDOS
PINZE VASCOLARI PEDIATRICE E NEONATALI**

Mehrzweckklemmen
Multipurpose clamps
Pinces polyvalants
Pinzas para multiples aplicaciones
Pinze per vari applicazione

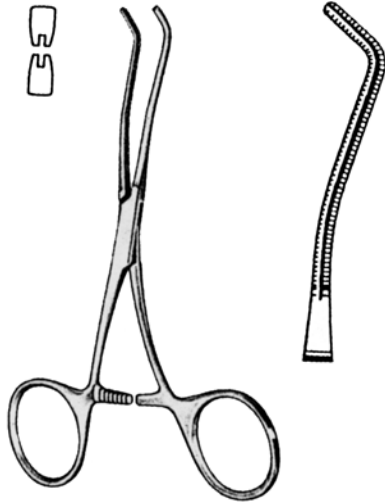

COOLEY
40.0920
13,5 cm

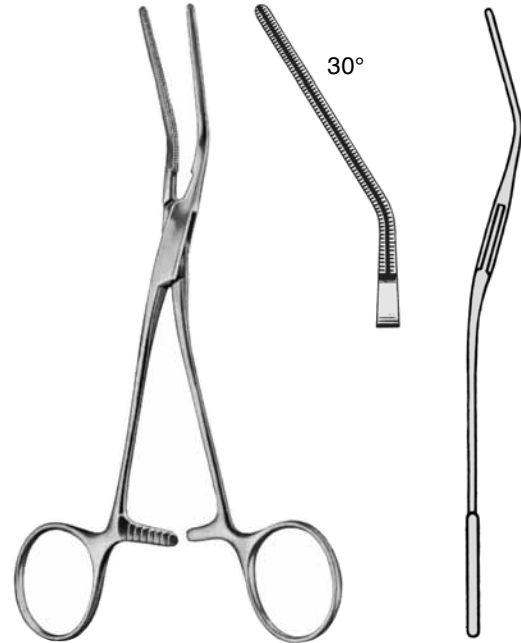

COOLEY
40.0925
17 cm / 30°



COOLEY
40.0930
15,5 cm / 60°



COOLEY
40.0935
15,5 cm / 90°

Patent-Ductus-Klemmen
Patent ductus clamps
Pinces pour patent ductus
Pinzas para conducto arterial
Pinze per patent ductus



COOLEY
40.1000
15,5 cm



COOLEY
40.1005
15,5 cm

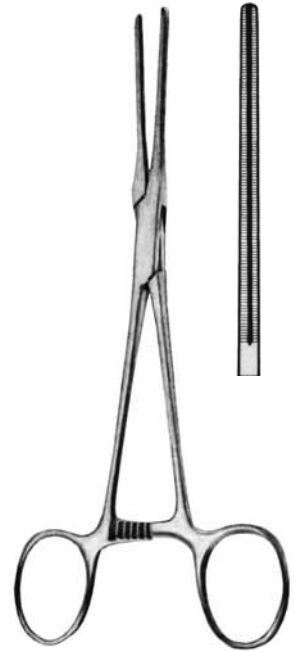

COOLEY
40.1025
17 cm



COOLEY
40.1030
17 cm

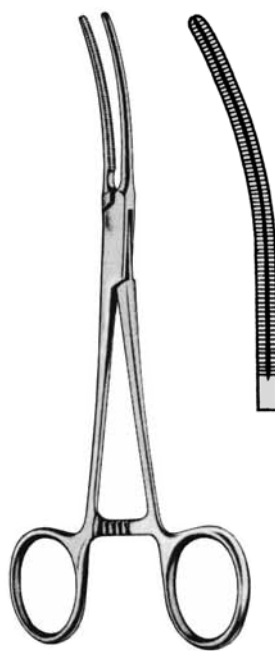

COOLEY
40.1035
17 cm

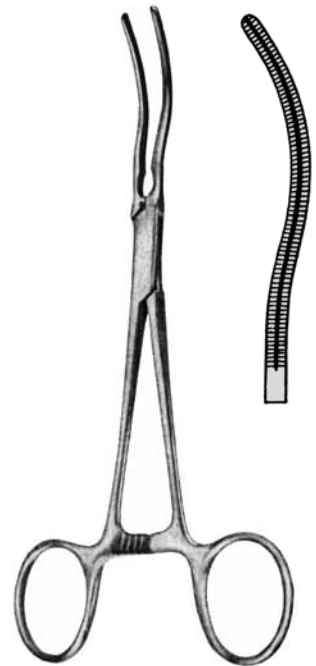

COOLEY
40.1036
17,5 cm

GEFÄSSKLEMMEN FÜR KINDER UND NEUGEBORENE
 PEDIATRIC- AND NEONATAL VASCULAR CLAMPS
 PINCES VASCULAIRES PEDIATRIQUES ET POUR NOUVEAUX NES
 PINZAS VASCULARES PEDIATRICAS Y PARA RACIEN NACIDOS
 PINZE VASCOLARI PEDIATRICE E NEONATALI



COOLEY

40.1150
12,5 cm

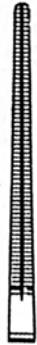

40.1152
12,5 cm

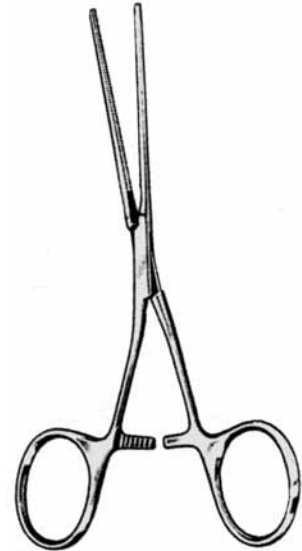

COOLEY
40.1151
13,5 cm/15°

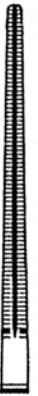

Mehrzweckklemmen
 Multipurpose clamps
 Pinces polyvalants
 Pinzas para multiples aplicaciones
 Pinze per vari applicazione



COOLEY

40.1153
13 cm



40.1154
12,5 cm/45°



COOLEY
40.1155
13,5 cm



COOLEY
40.1157
10,5 cm/90°

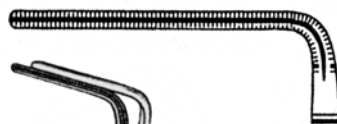

COOLEY
40.1158
12 cm

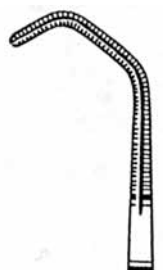



40.2150
 14,5 cm
 Fig.1



40.2151
 14,5 cm
 Fig.2



40.2152
 14,5 cm
 Fig.3



40.2153
 14,5 cm
 Fig.4



40.2154
 14,5 cm
 Fig.5



40.2155
 14,5 cm
 Fig.6

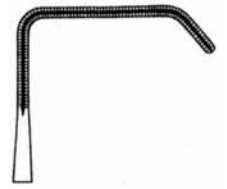

40.2156
 14,5 cm
 Fig.7

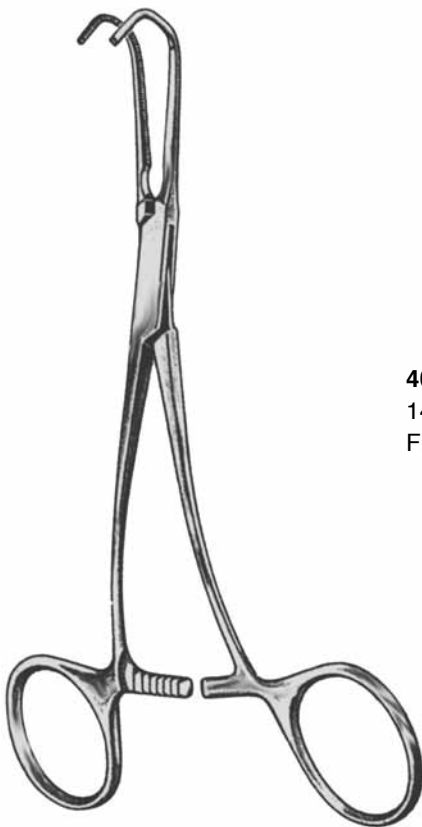

COOLEY-BABY



40.2157
 14,5 cm
 Fig.8



40.2158
 14,5 cm
 Fig. 9



40.2159
 14,5 cm
 Fig.10

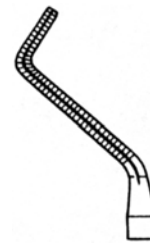

40.2160
 14,5 cm
 Fig.11

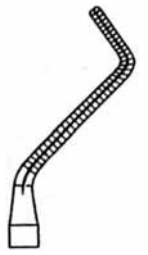

40.2161
 14,5 cm
 Fig.12

GEFÄSSKLEMMEN FÜR KINDER UND NEUGEBORENE
PEDIATRIC- AND NEONATAL VASCULAR CLAMPS
PINCES VASCULAIRES PEDIATRIQUES ET POUR NOUVEAUX NES
PINZAS VASCULARES PEDIATRICAS Y PARA RACIEN NACIDOS
PINZE VASCOLARI PEDIATRICE E NEONATALI



NEONATAL
40.2588
16,5 cm

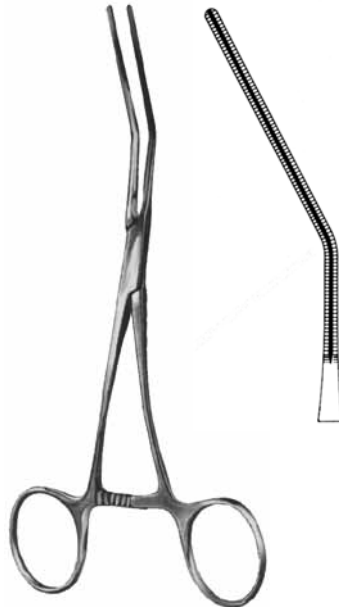

NEONATAL
40.2589
16 cm



NEONATAL
40.2590
15 cm



NEONATAL
40.2591
15 cm



NEONATAL
40.2592
15,5 cm



GLOVER

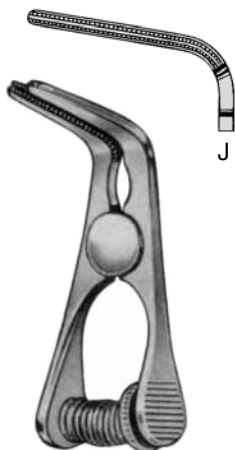

GLOVER

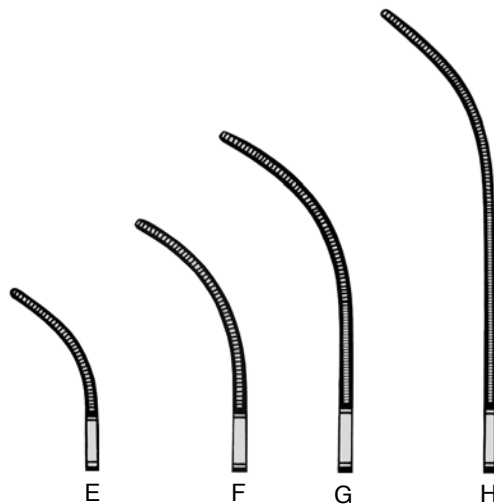

Artikel Item	Fig.	Gesamtlänge Overall length Longeur complet largo total Lunghezza totali	Maullänge Jaw length longeur de mors largo de boca Lunghezza del morso	Gewicht Weight Poids Peso Peso
41.0000	A	60 mm	20 mm	5 g
41.0001	E	55 mm	20 mm	5 g
41.0005	B	70 mm	30 mm	9 g
41.0006	F	65 mm	30 mm	9 g
41.0010	C	90 mm	43 mm	12 g
41.0011	G	85 mm	43 mm	12 g
41.0015	D	105 mm	56 mm	14 g
41.0016	H	100 mm	56 mm	14 g
41.0019	J	55 mm	25 mm	7 g

ATRAUMATISCHE BULLDOGKLEMMEN
NON-TRAUMATIC BULLDOG CLAMPS
CLAMPS BULLDOG NON-TRAUMATISANTS
CLAMPS BULLDOG ATRAUMATICAS
CLAMPS ATRAUMA BULLDOG



GREGORY

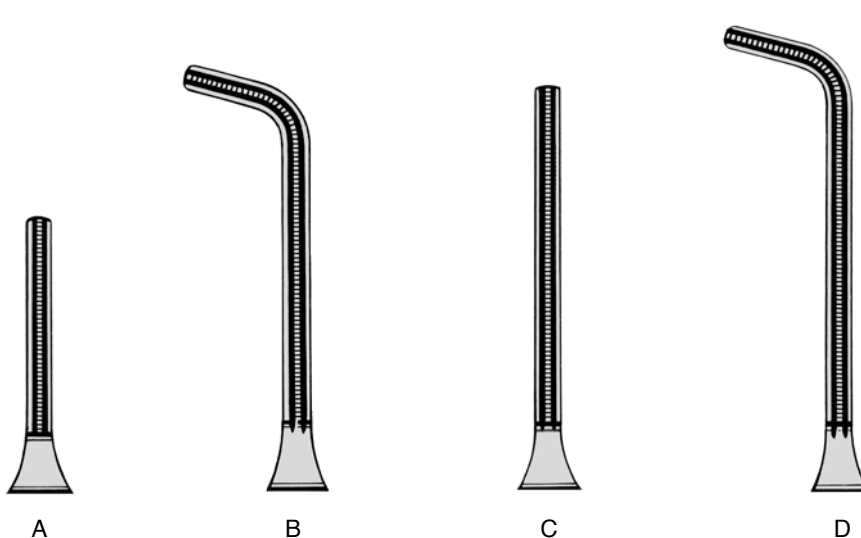

Artikel Item	Fig.	Gesamtlänge Overall length Longeur complet largo total Lunghezza totale	Maullänge Jaw length longeur de mors largo de boca Lunghezza del morsi
-----------------	------	---	--

41.0020	A	90 mm	27 mm
41.0021	B	100 mm	44 mm
41.0022	C	110 mm	55 mm
41.0023	D	110 mm	60 mm



GREGORY

nach rechts gebogen
 curved to right
 courbe à droit
 curva a la derecha
 curvo a destra



A

nach links gebogen
 curved to left
 courbe à gauche
 curva a la izquierda
 curvo a sinistra



B

Artikel Item	Fig.	Gesamtlänge Overall length Longeur complet largo total Lunghezza totale	Maullänge Jaw length longeur de mors largo de boca Lunghezza del morsi
-----------------	------	---	--

41.0024	A	110 mm	60 mm
41.0025	B	110 mm	60 mm

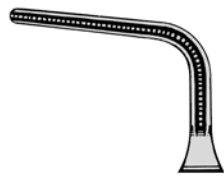

30 mm Maullänge
 Jaw length
 longueur de mors
 largo de boca
 Lunghezza del morso

SANTULLI
41.0028
 70 mm



DIETRICH



A



B



C



D

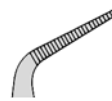

E

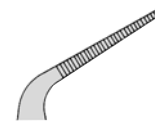

F

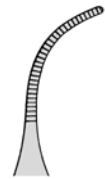

G

Artikel Item	Fig.	Gesamtlänge Overall length Longeur complet largo total Lunghezza totale	Maullänge Jaw length longueur de mors largo de boca Lunghezza del morso	Schliesdruck Closing pressure Pression d'Occlusion Presión de cierre Pressione di chiusura
41.0030	A	50 mm	8 mm	50
41.0031	D	43 mm	8 mm	50
41.0032	B	53 mm	12 mm	50
41.0033	E	45 mm	12 mm	50
41.0034	C	60 mm	20 mm	50
41.0035	F	50 mm	20 mm	50
41.0037	G	54 mm	20 mm	50

ATRAUMATISCHE BULLDOGKLEMMEN
NON-TRAUMATIC BULLDOG CLAMPS
CLAMPS BULLDOG NON-TRAUMATISANTS
CLAMPS BULLDOG ATRAUMATICAS
CLAMPS ATRAUMA BULLDOG

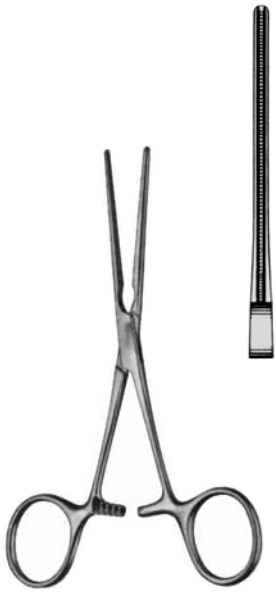

DEBAKEY
41.0130
 12.5 cm



DEBAKEY
41.0132
 12.5 cm



DEBAKEY
41.0134
 12.5 cm 45°



DEBAKEY
41.0136
 10 cm 90°



DEBAKEY
41.0138
 12.5 cm



DEBAKEY-SATINSKY
41.0140 5,5 cm
41.0144 6,5 cm

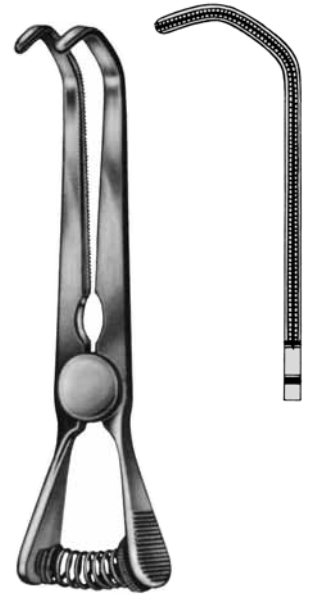

DEBAKEY-SATINSKY
41.0146 10 cm



DEBAKEY-CAROTID
41.0147 9 cm



41.0150
 12 cm



14 cm



16 cm



18 cm

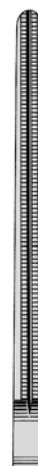

20 cm

DEBAKEY-PEAN

41.0160 14 cm

41.0162 16 cm

41.0164 18 cm

41.0166 20 cm

DEBAKEY-MOSQUITO

41.0150 12 cm



41.0151
 12 cm



14 cm



16 cm



18 cm

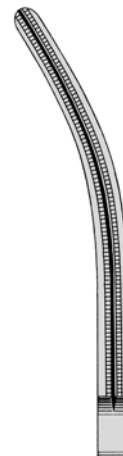

20 cm

DEBAKEY-PEAN

41.0161 14 cm

41.0163 16 cm

41.0165 18 cm

41.0167 20 cm

DEBAKEY-MOSQUITO

41.0151 12 cm



40.1750
15 cm

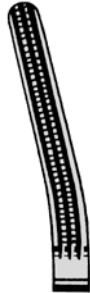

40.1751
15 cm
15°



40.1752
15 cm
30°

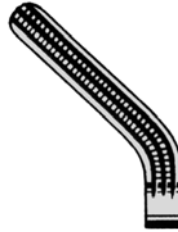

40.1753
14 cm
45°



40.1754
13 cm
90°

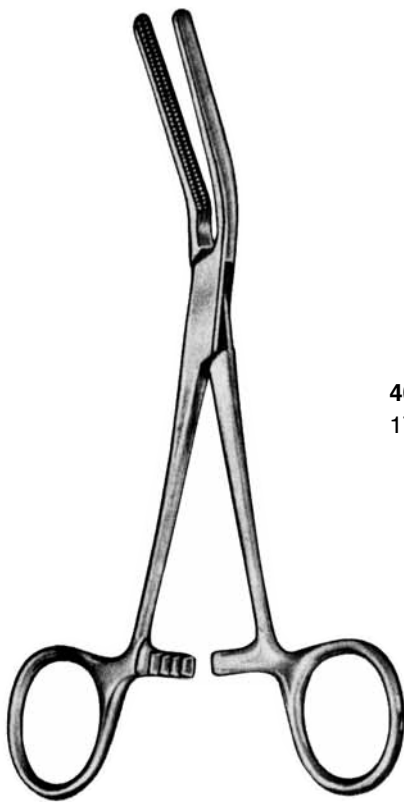

DARDICK



40.1760
17 cm

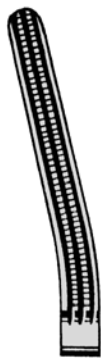

40.1761
17 cm
15°



40.1762
17 cm
30°

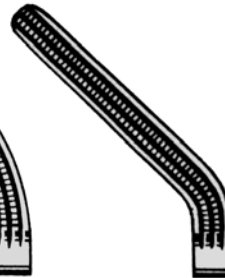

40.1763
16 cm
45°



40.1764
14 cm
90°

ATRAUMATISCHE GEFÄSSKLEMMEN
NON-TRAUMATIC VASCULAR CLAMPS
PINCES-CLAMPS VASCULAIRES ATRAUMATIQUES
PINZAS-CLAMPS VASCULARES ATRAUMATICAS
PINZE VASCOLARI CON STRIATURA ATRAUMATICA

Mehrzweckklemmen
 Multipurpose clamps
 Pinces polyvalents
 Pinzas para multiples aplicaciones
 Pinze per vari applicazione



COOLEY

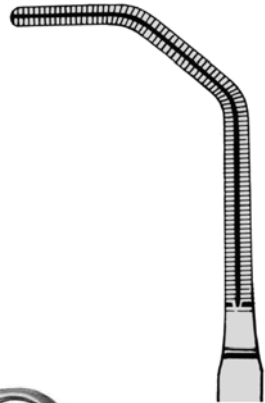

40.0950
17,5 cm

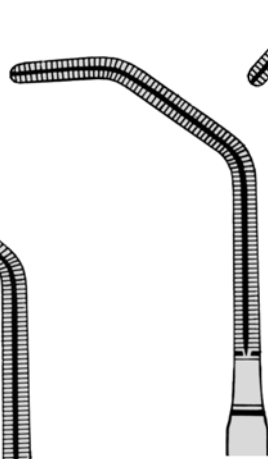

40.0955
17,5 cm

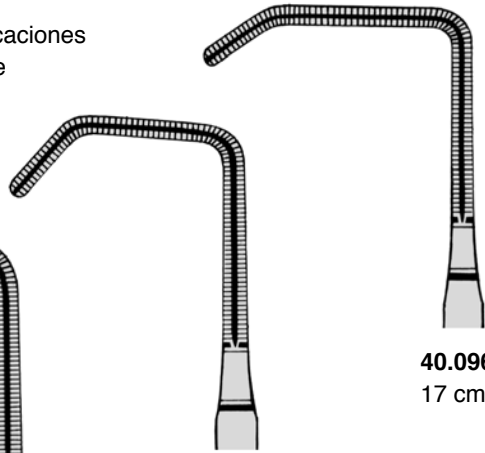

40.0960
17 cm

40.0965
17 cm



COOLEY
40.0976
17 cm

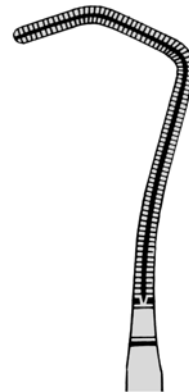

ATRAUMATISCHE GEFÄSSKLEMMEN
NON-TRAUMATIC VASCULAR CLAMPS
PINCES-CLAMPS VASCULAIRES ATRAUMATIQUES
PINZAS-CLAMPS VASCULARES ATRAUMATICAS
PINZE VASCOLARI CON STRIATURA ATRAUMATICA

Anastomosenklemmen
 Anastomosis clamps
 Pinces à anastomoses
 Pinzas para anastomosis
 Pinze per anastomosi

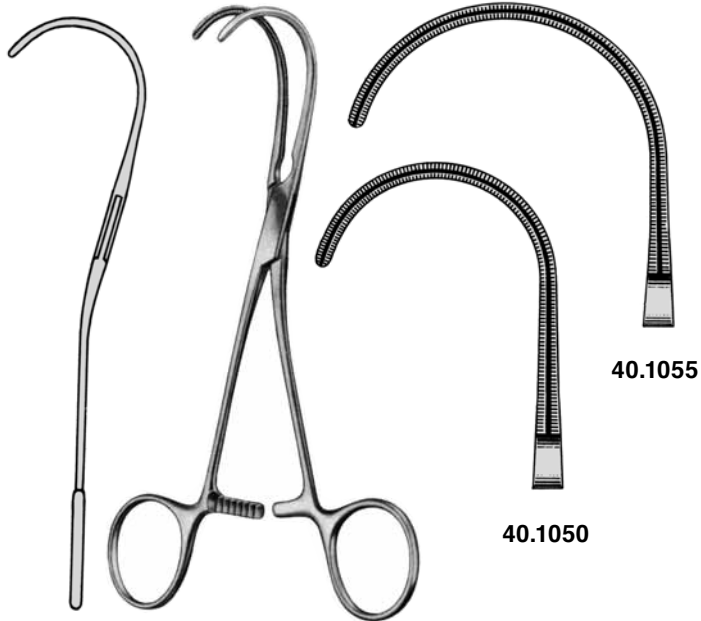

COOLEY-BECK
 15 cm

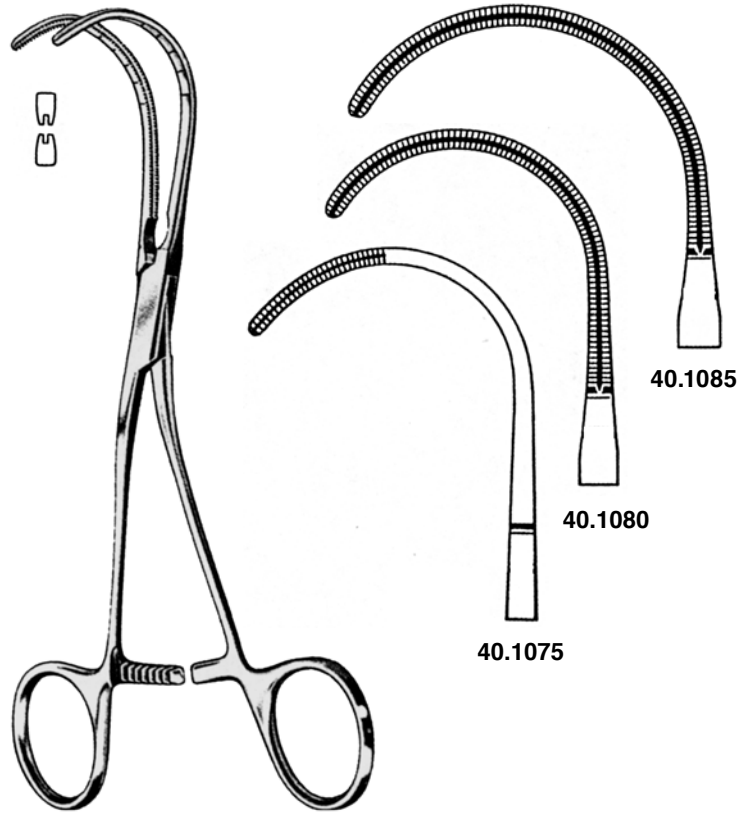

COOLEY
 17 cm

Nierenarterienklemmen
 Renal hemostatic clamps
 Pinces pour artères rénales
 Pinzas para arteria renal
 Pinze per arteria renale

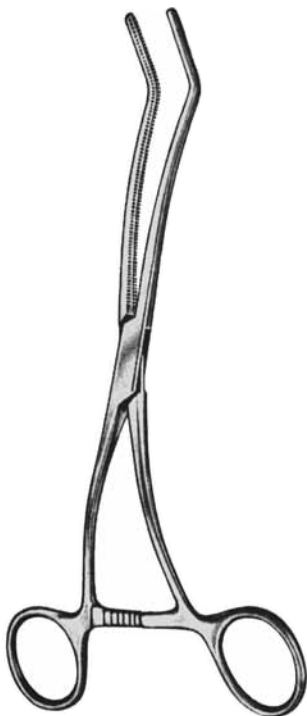

COOLEY

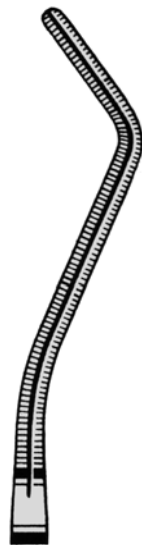

40.1090
 18,5 cm

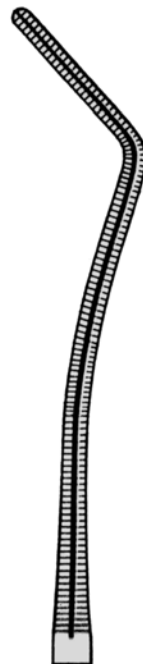

40.1091
 20 cm

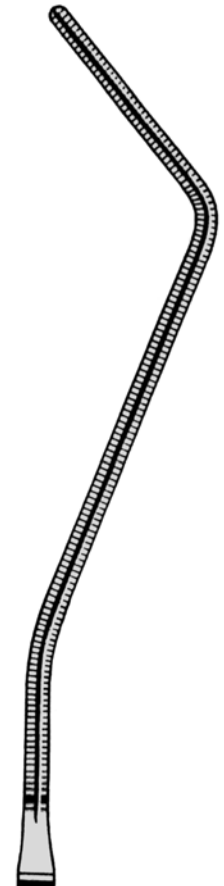

40.1092
 28 cm

ATRAUMATISCHE GEFÄSSKLEMMEN
NON-TRAUMATIC VASCULAR CLAMPS
PINCES-CLAMPS VASCULAIRES ATRAUMATIQUES
PINZAS-CLAMPS VASCULARES ATRAUMATICAS
PINZE VASCOLARI CON STRIATURA ATRAUMATICA

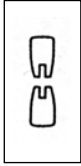

COOLEY

40.1300
21 cm

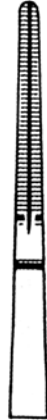

40.1302
22 cm

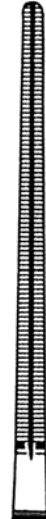

40.1304
26 cm

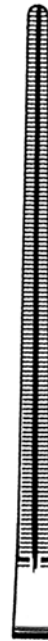

Patent-Ductus-Klemmen
 Patent ductus clamps
 Pincés pour patent ductus
 Pinzas para conducto arterial
 Pinze per patent ductus



COOLEY

40.1301
20,5 cm

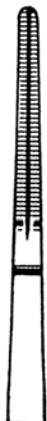

40.1303
22 cm

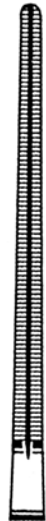

40.1305
25,5 cm

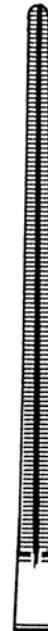

ATRAUMATISCHE GEFÄSSKLEMMEN
NON-TRAUMATIC VASCULAR CLAMPS
PINCES-CLAMPS VASCULAIRES ATRAUMATIQUES
PINZAS-CLAMPS VASCULARES ATRAUMATICAS
PINZE VASCOLARI CON STRIATURA ATRAUMATICA

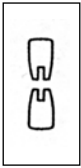

Mehrzweckklemmen
Multipurpose clamps
Pinces polyvalents
Pinzas para multiples aplicaciones
Pinze per vari applicazione



COOLEY

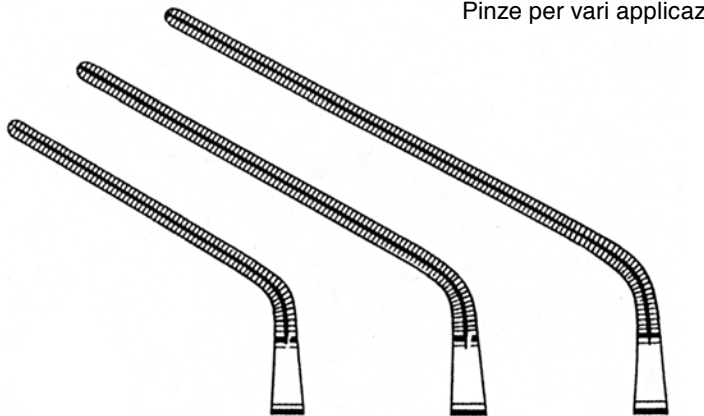

40.1333
16 cm

40.1334
17 cm

40.1335
18 cm

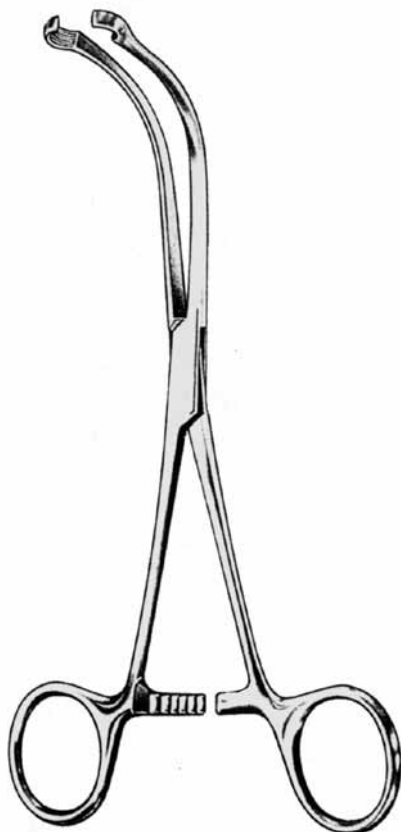

JAVID

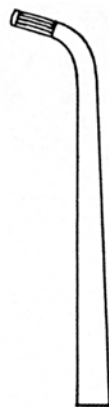

40.1340
17 cm

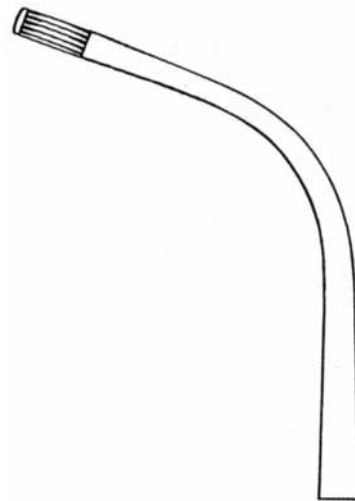

40.1342
19 cm

Carotisklemmen
Carotid clamps
Pinces pour carotide
Pinzas para carótida
Pinze per carotis

ATRAUMATISCHE GEFÄSSKLEMMEN
NON-TRAUMATIC VASCULAR CLAMPS
PINCES-CLAMPS VASCULAIRES ATRAUMATIQUES
PINZAS-CLAMPS VASCULARES ATRAUMATICAS
PINZE VASCOLARI CON STRIATURA ATRAUMATICA

Katheterklemmen
 Catheter Clamps
 Clamps pour sondes
 Clamps para catéteres
 Pinze per cateteri



COOLEY

40.1350	16 cm	24 Fr.
40.1351	16 cm	26 Fr.
40.1352	20 cm	28 Fr.
40.1353	20 cm	30 Fr.
40.1354	20 cm	32 Fr.
40.1355	20 cm	34 Fr.
40.1357	20 cm	36 Fr.

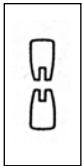

COOLEY

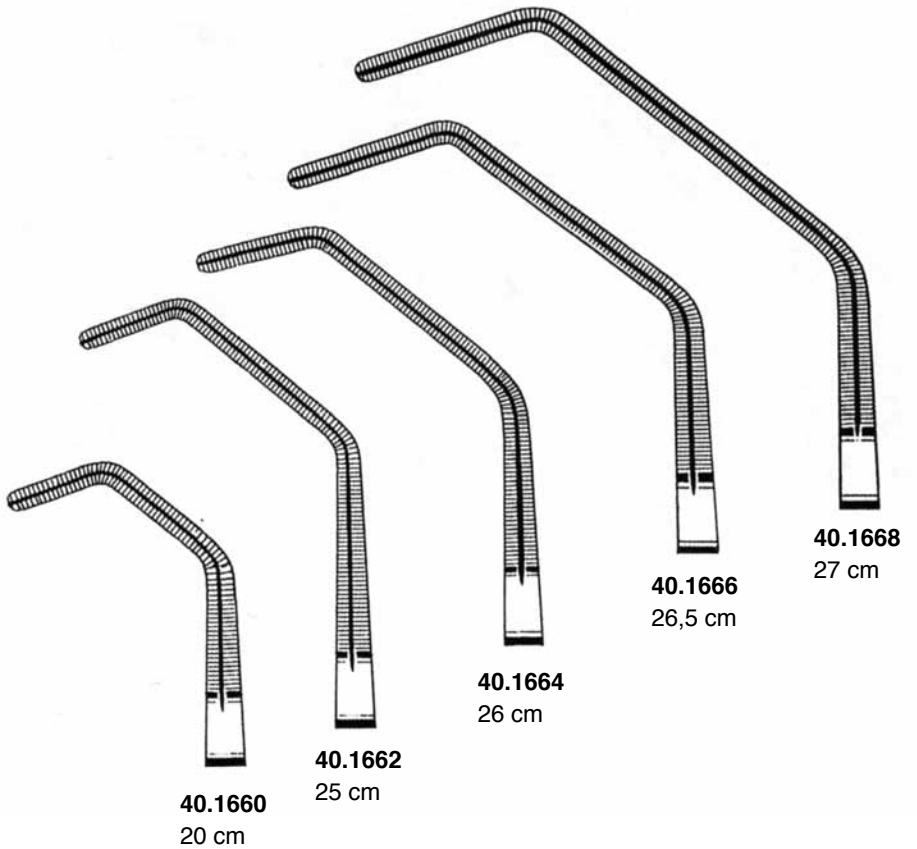

Tangential-Verschluss-Klemmen
 Tangential occlusion clamps
 Pinces pour occlusion tangentielle
 Pinzas para oclusión tangencial
 Pinze per occlusione tangenziale

Iliac-Klemmen
 Iliac clamps
 Pincés pour veine iliaque
 Pinzas para iliaca
 Pinze per vena iliaca



COOLEY

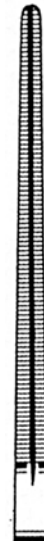

40.1690
22 cm

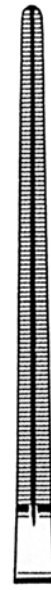

40.1691
26 cm



COOLEY
40.1698
30 cm

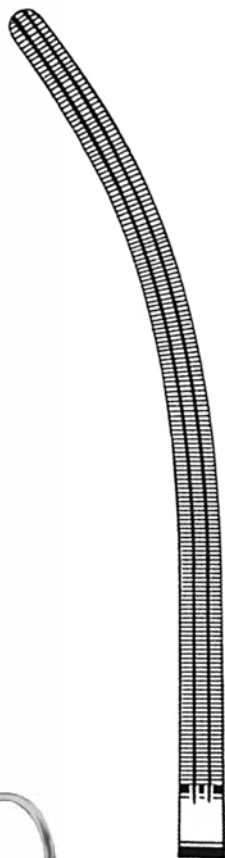

Mehrzweckklemmen
 Multipurpose clamps
 Pincés polyvalents
 Pinzas para múltiples aplicaciones
 Pinze per vari applicazione

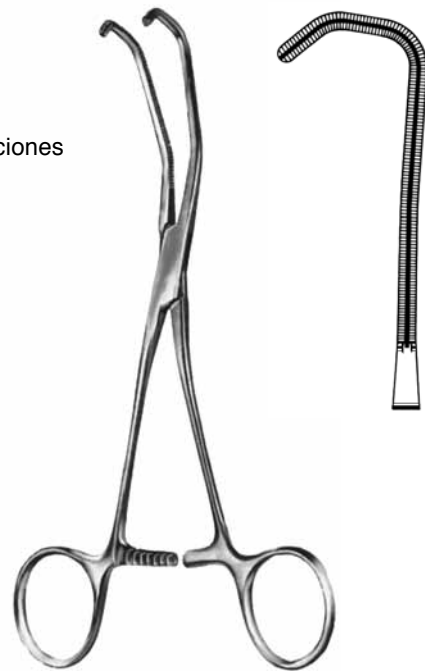

COOLEY
40.1729
17 cm

ATRAUMATISCHE GEFÄSSKLEMMEN
NON-TRAUMATIC VASCULAR CLAMPS
PINCES-CLAMPS VASCULAIRES ATRAUMATIQUES
PINZAS-CLAMPS VASCULARES ATRAUMATICAS
PINZE VASCOLARI CON STRIATURA ATRAUMATICA

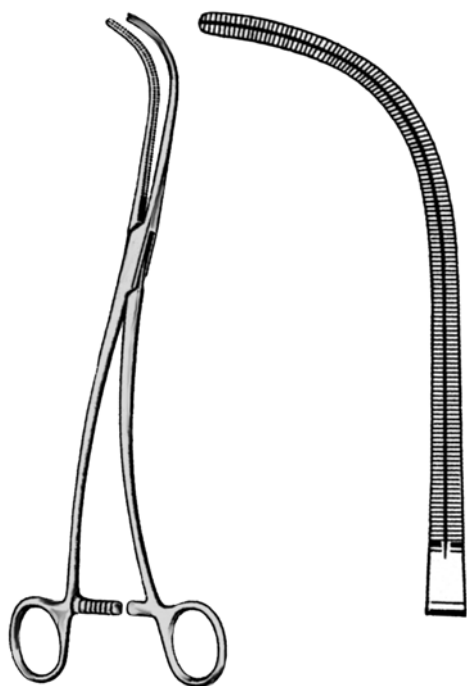

COOLEY
40.1765
 28 cm



COOLEY

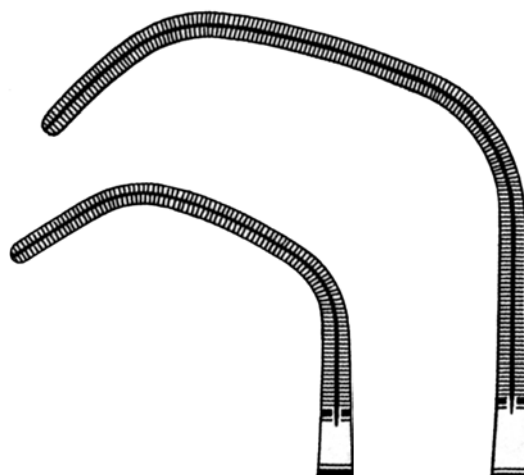

40.1769
 22 cm

40.1770
 27 cm

Mehrzweckklemmen
 Multipurpose clamps
 Pinces polyvalents
 Pinzas para multiples aplicaciones
 Pinze per vari applicazione

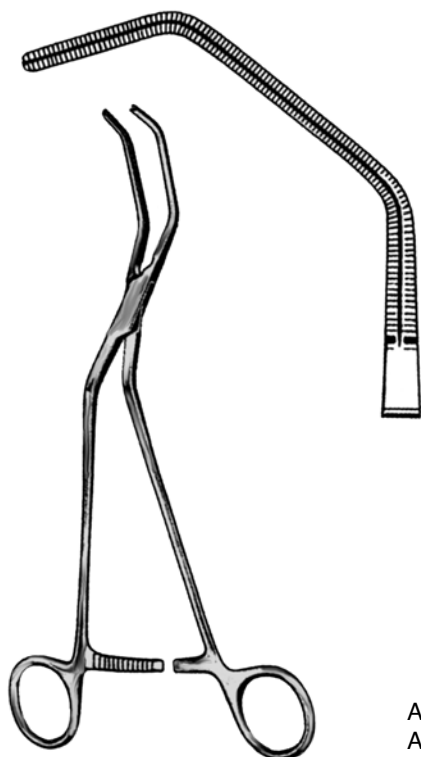

COOLEY
40.1773
 26 cm

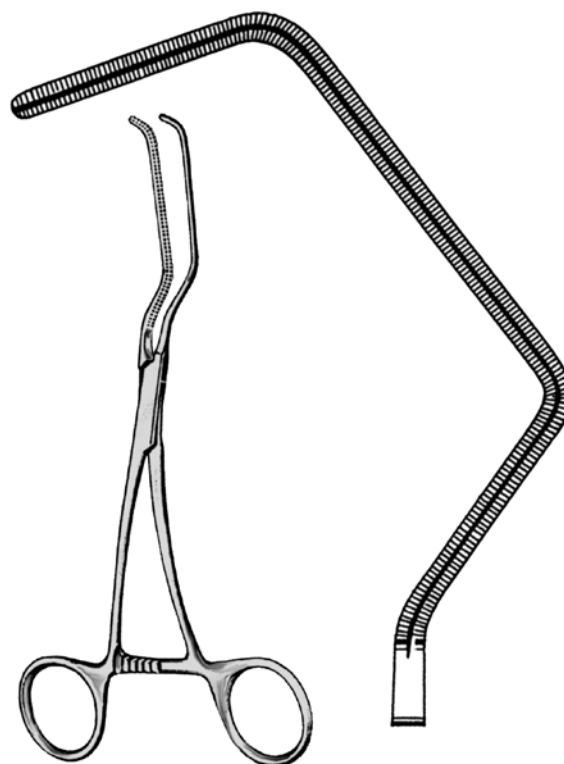

COOLEY-PARRY
40.1775
 26 cm

Anastomosenklemmen
 Anastomosis clamps
 Pinces à anastomoses
 Pinzas para anastomosis
 Pinze per anastomosi

Patent-Ductusklemmen
Patent Ductus Clamps
Pinces pour patent ductus
Pinzas para conducto arterial
Pinze per patent ductus

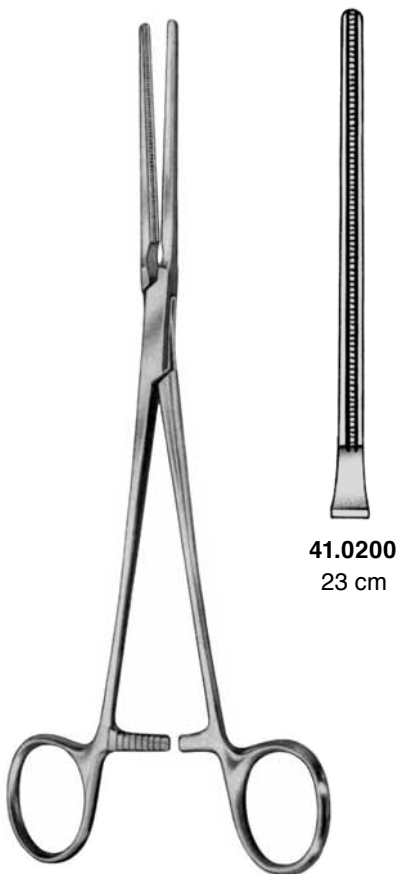

41.0200
23 cm



41.0210
19,5 cm

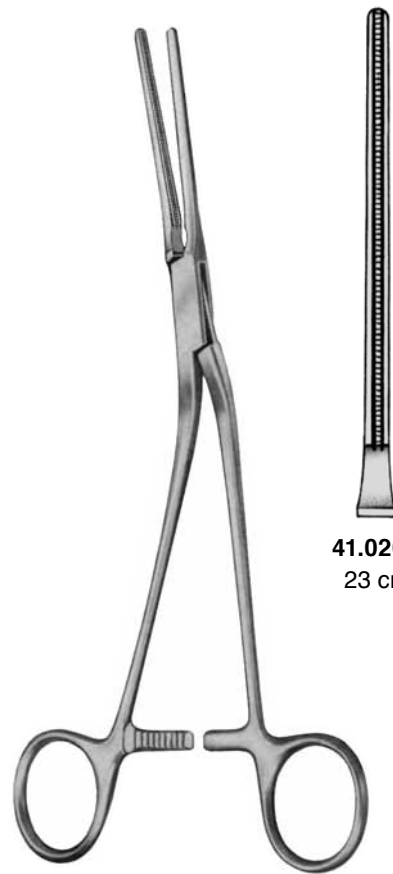

41.0203
23 cm

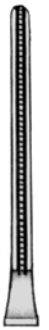

41.0213
19,5 cm

DEBAKEY

DEBAKEY

ATRAUMATISCHE GEFÄSSKLEMMEN
NON-TRAUMATIC VASCULAR CLAMPS
PINCES-CLAMPS VASCULAIRES ATRAUMATIQUES
PINZAS-CLAMPS VASCULARES ATRAUMATICAS
PINZE VASCOLARI CON STRIATURA ATRAUMATICA

Peripheralgefäßklemmen
Peripheral Vascular Clamps
Pinces pour vaisseaux périphériques
Pinzas para vasos periféricos
Pinze per vasi periferici



DEBAKEY
41.0235 18 cm



41.0240
20 cm

DEBAKEY

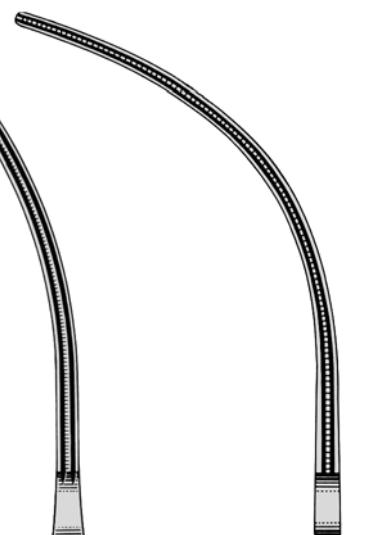

41.0245
20 cm

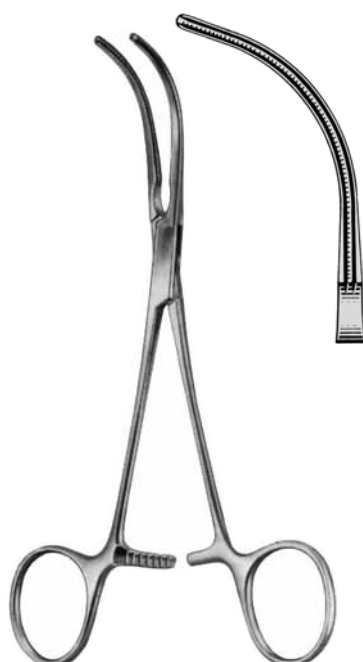

DEBAKEY
41.0250 15 cm



Mehrzweckklemmen
Multipurpose clamps
Pinces polyvalants
Pinzas para multiples aplicaciones
Pinze per vari applicazioni



41.0260
17 cm

41.0262
18,5 cm

DEBAKEY-BAINBRIDGE



41.0265
17 cm

41.0267
18,5 cm

DEBAKEY-BAINBRIDGE

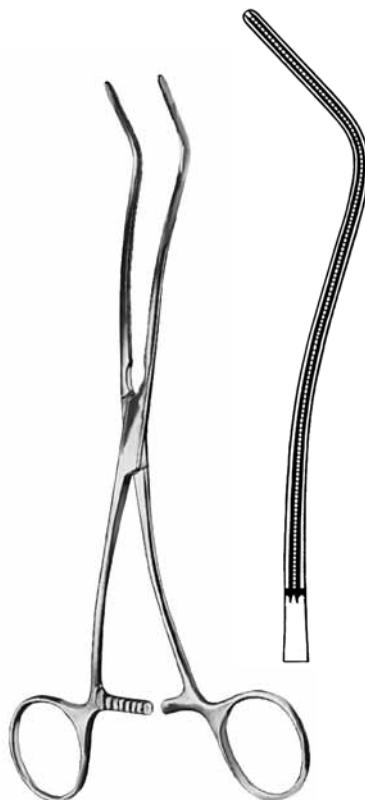

DEBAKEY
41.0270
20 cm

ATRAUMATISCHE GEFÄSSKLEMMEN
NON-TRAUMATIC VASCULAR CLAMPS
PINCES-CLAMPS VASCULAIRES ATRAUMATIQUES
PINZAS-CLAMPS VASCULARES ATRAUMATICAS
PINZE VASCOLARI CON STRIATURA ATRAUMATICA

Peripheralgefäßklemmen
 Peripheral Vascular Clamps
 Pincés pour vaisseaux périphériques
 Pinzas para vasos periféricos
 Pinze per vasi periferici



LELAND-JONES

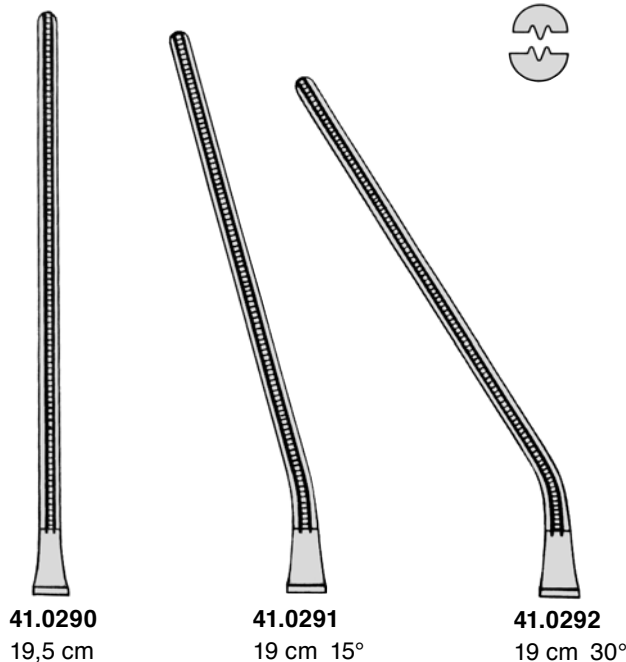

41.0290
19,5 cm

41.0291
19 cm 15°

41.0292
19 cm 30°



DEBAKEY-OCHSNER
41.0317 23 cm

Aorta-Klemmen
 Aorta clamps
 Pincés pour l'aorte
 Pinzas para aorta
 Pinze per aorta



DEBAKEY-DIETRICH
41.0319 21 cm

Peripheralgefäßklemmen
 Peripheral Vascular Clamps
 Pincés pour vaisseaux périphériques
 Pinzas para vasos periféricos
 Pinze per vasi periferici



DEBAKEY-DALE
41.0340 18,5 cm

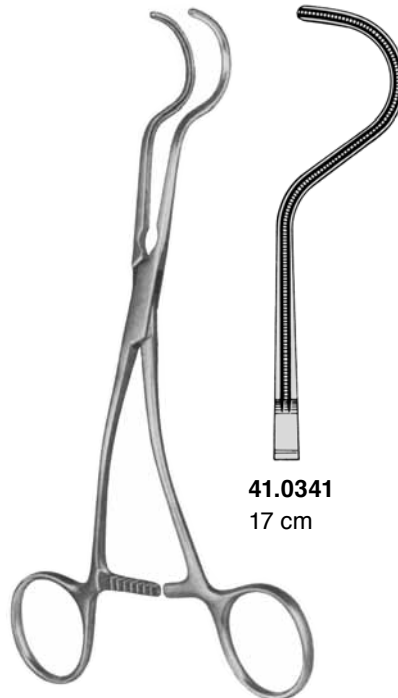

41.0341
17 cm

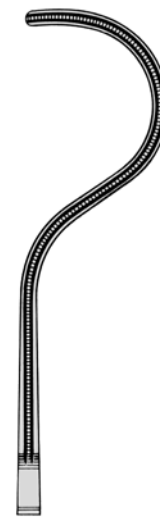

41.0342
17,5 cm

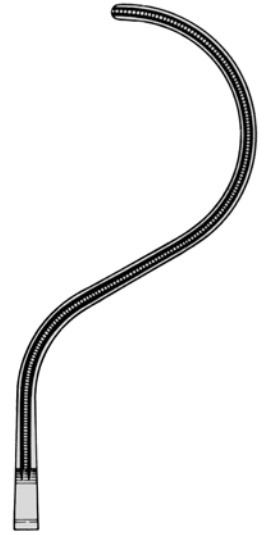

41.0343
18,5 cm

DEBAKEY-DALE

Profundaklemmen
 Profunda Clamps
 Pincés fémorale
 Pinzas para la profunda
 Pinze profuna



DEBAKEY-GREGORY

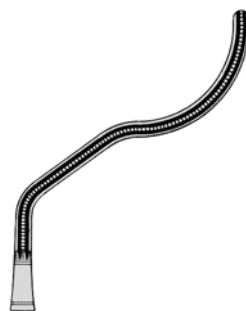

41.0345
14 cm

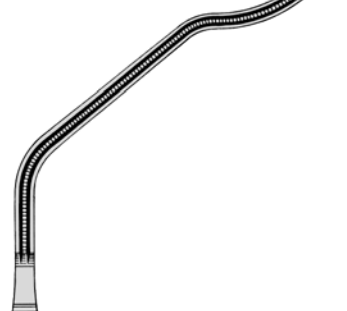

41.0346
16 cm

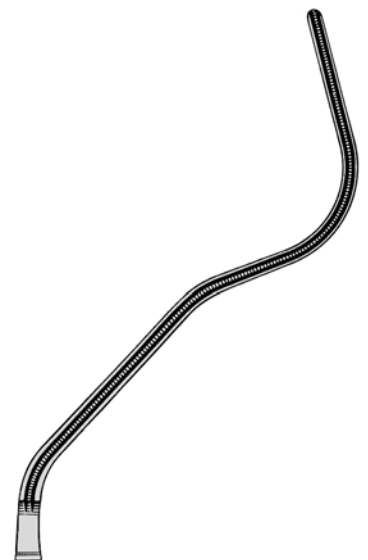

41.0347
18 cm

ATRAUMATISCHE GEFÄSSKLEMMEN
NON-TRAUMATIC VASCULAR CLAMPS
PINCES-CLAMPS VASCULAIRES ATRAUMATIQUES
PINZAS-CLAMPS VASCULARES ATRAUMATICAS
PINZE VASCOLARI CON STRIATURA ATRAUMATICA

Aorta-Aneurysma-Klemmen
Aortic aneurysm clamps
Pinces pour anévrisme de l'aorte
Pinzas para aneurisma de aorta
Pinze per aneurisma d'aorta



DEBAKEY

Aorta-Aneurysma-Klemmen
Aortic aneurysm clamps
Pinces pour anévrisme de l'aorte
Pinzas para aneurisma de aorta
Pinze per aneurisma d'aorta

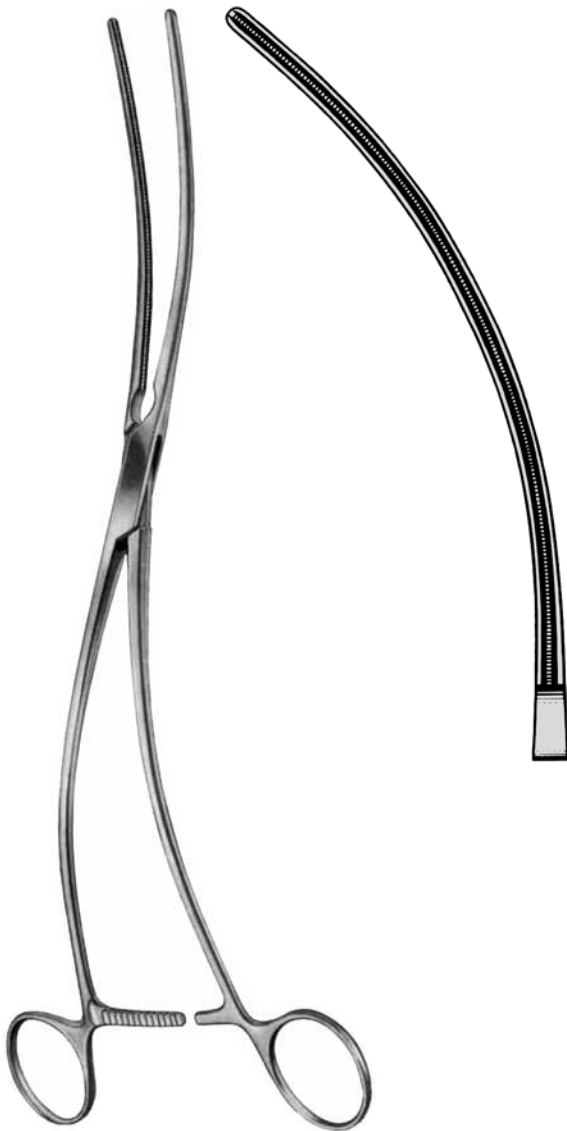

DEBAKEY
41.0610 31,5 cm



DEBAKEY
41.0620 28 cm

ATRAUMATISCHE GEFÄSSKLEMMEN
NON-TRAUMATIC VASCULAR CLAMPS
PINCES-CLAMPS VASCULAIRES ATRAUMATIQUES
PINZAS-CLAMPS VASCULARES ATRAUMATICAS
PINZE VASCOLARI CON STRIATURA ATRAUMATICA

Aorta-Klemmen
Aorta clamps
Pincés pour l'aorte
Pinzas para aorta
Pinze per aorta

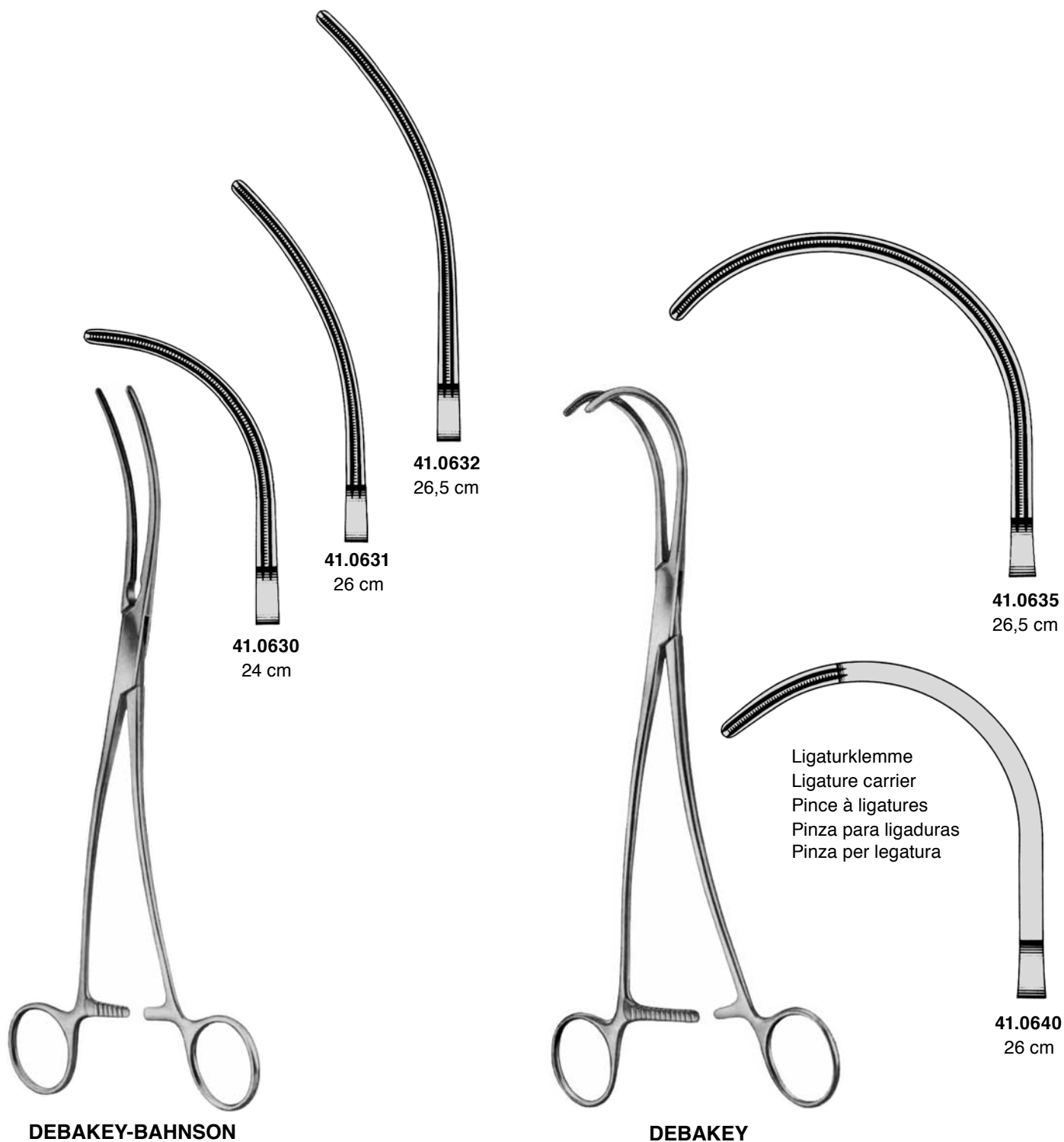

Aorta-Klemmen
Aorta clamps
Pinces pour l'aorte
Pinzas para aorta
Pinze per aorta

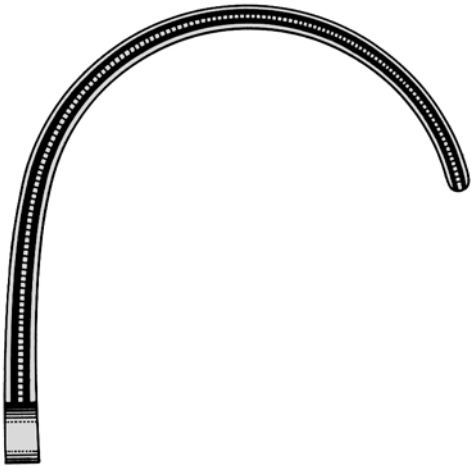

WEBER
41.0642 26 cm
links
left
à gauche
a izquierda
sinistra



WEBER
41.0643 26 cm
rechts
right
à droite
a derecha
destra

ATRAUMATISCHE GEFÄSSKLEMMEN
NON-TRAUMATIC VASCULAR CLAMPS
PINCES-CLAMPS VASCULAIRES ATRAUMATIQUES
PINZAS-CLAMPS VASCULARES ATRAUMATICAS
PINZE VASCOLARI CON STRIATURA ATRAUMATICA

Aorta-Klemmen
Aorta clamps
Pinces pour l'aorte
Pinzas para aorta
Pinze per aorta



DIETHRICH
41.0645
21 cm

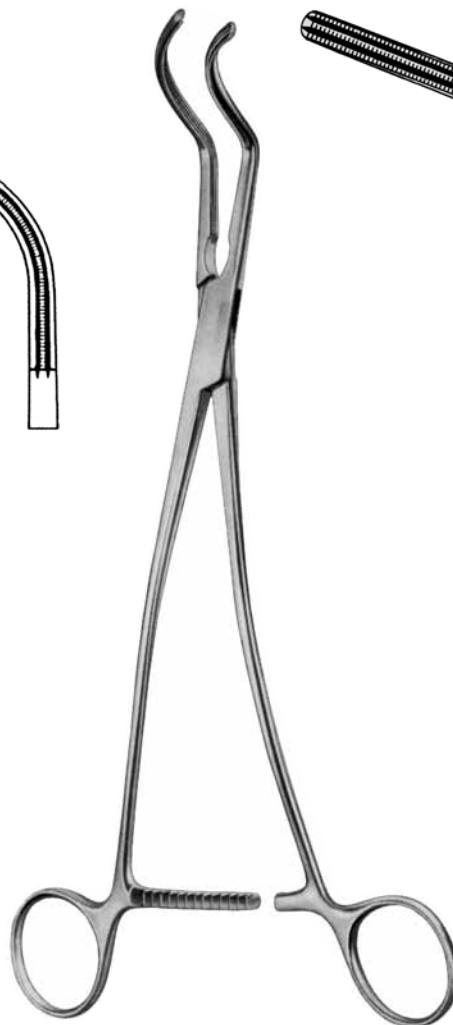
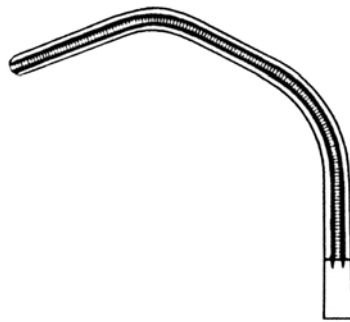

DEBAKEY
41.0650
26 cm



ATRAUMATISCHE GEFÄSSKLEMMEN
NON-TRAUMATIC VASCULAR CLAMPS
PINCES-CLAMPS VASCULAIRES ATRAUMATIQUES
PINZAS-CLAMPS VASCULARES ATRAUMATICAS
PINZE VASCOLARI CON STRIATURA ATRAUMATICA



CALNE
41.0649
 27 cm

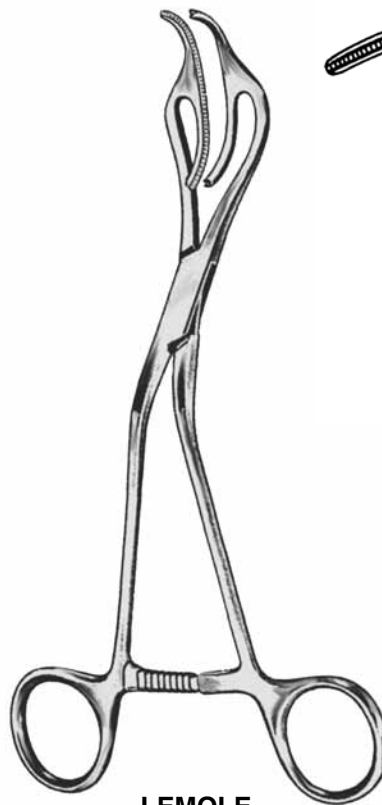

LEMOLE
 20,5 cm

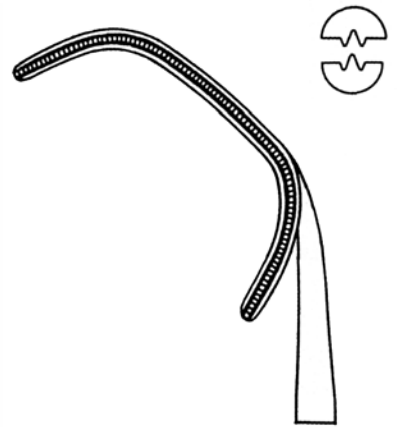

41.0652
 4,1x1,6 cm
41.0654
 4,5x2,3 cm

Aorta-Klemmen
 Aorta clamps
 Pinces pour l'aorte
 Pinzas para aorta
 Pinze per aorta



WYLIE

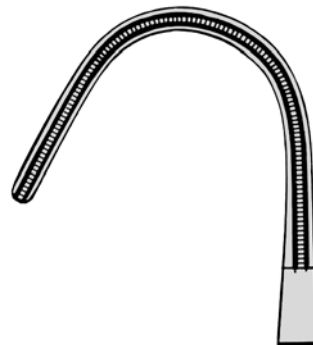

41.0655
 23 cm

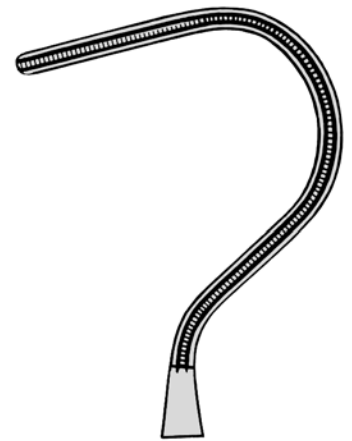

41.0656
 22 cm

ATRAUMATISCHE GEFÄSSKLEMMEN
NON-TRAUMATIC VASCULAR CLAMPS
PINCES-CLAMPS VASCULAIRES ATRAUMATIQUES
PINZAS-CLAMPS VASCULARES ATRAUMATICAS
PINZE VASCOLARI CON STRIATURA ATRAUMATICA



Aorta-Klemmen
 Aorta clamps
 Pinces pour l'aorte
 Pinzas para aorta
 Pinze per aorta



LAMBERT-KAY
 41.0657
 21 cm

DEBAKEY-LAMBERT
 41.0659
 26 cm

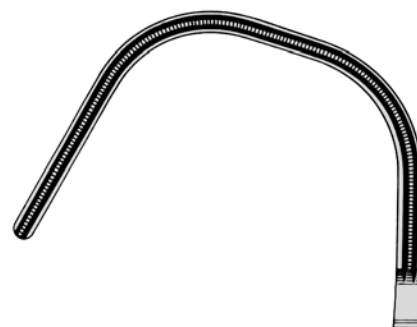

LAMBERT-KAY
 41.0658
 21 cm



SATINSKY

Tangential-Verschluss-Klemmen
 Tangential occlusion clamps
 Pinces pour occlusion tangentielle
 Pinzas para oclusión tangencial
 Pinze per occlusione tangenziale

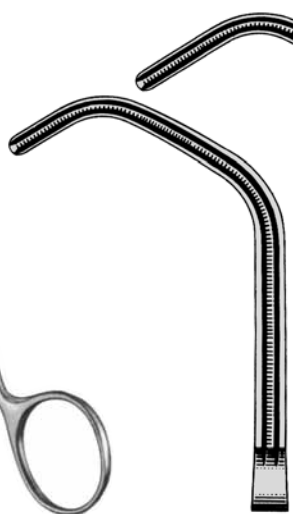

41.0660
 20 cm

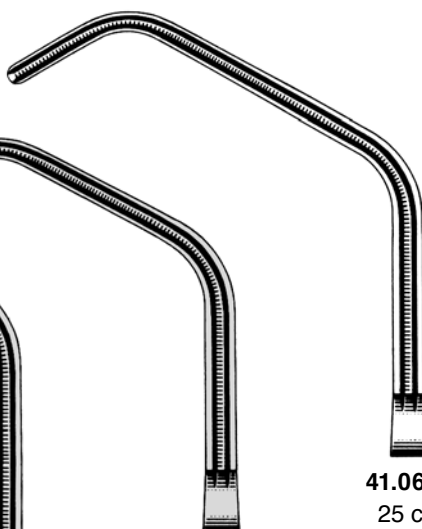

41.0662
 24 cm

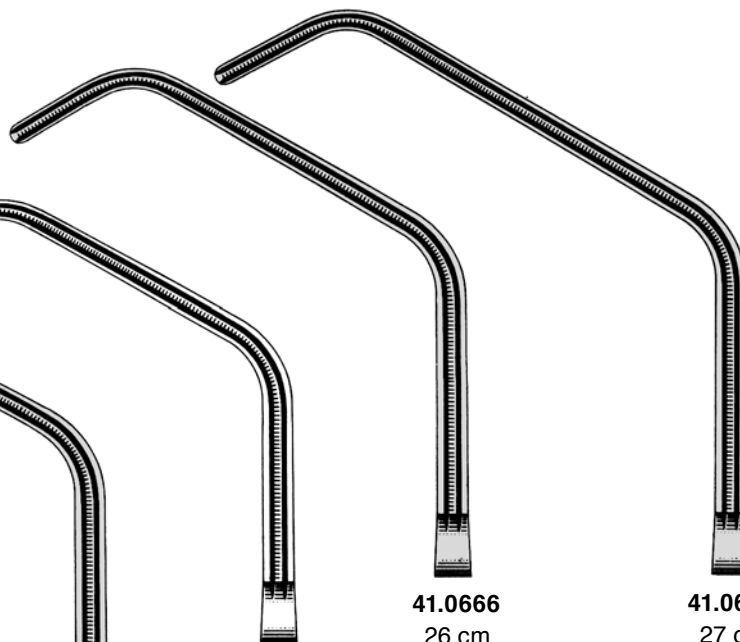

41.0664
 25 cm

41.0666
 26 cm

41.0668
 27 cm

SATINSKY
 41.0670
 Satz 41.0660-41.0668
 Set 41.0660-41.0668
 Jeu 41.0660-41.0668
 Juego 41.0660-41.0668

Mehrzweckklemmen
 Multipurpose clamps
 Pinces polyvalents
 Pinzas para multiples aplicaciones
 Pinze per vari applicazione

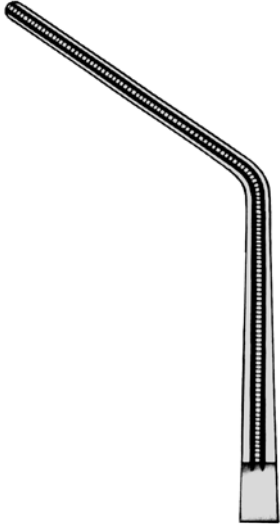

41.0680
 25 cm 60°

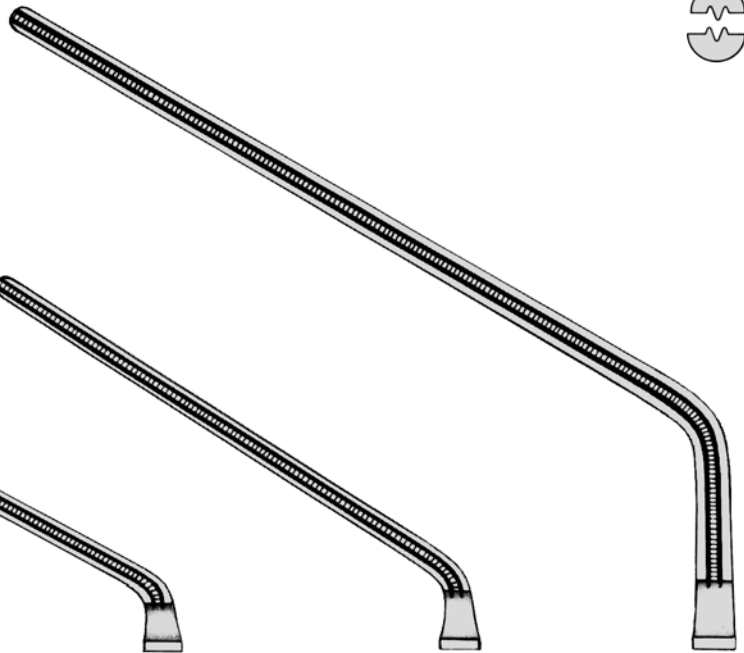

41.0686
 31 cm 60°

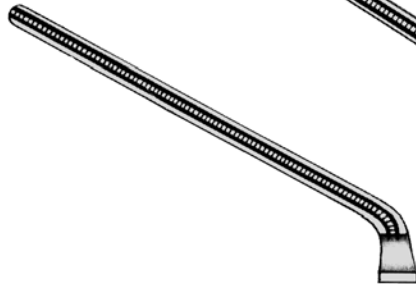

41.0682
 21 cm 60°

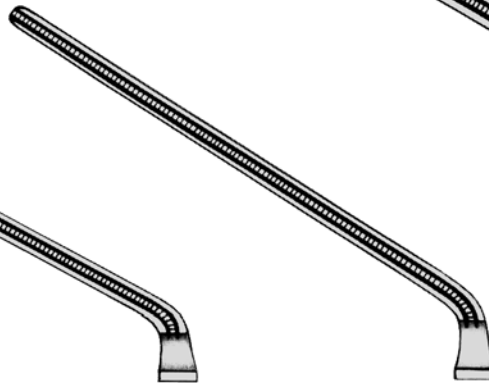

41.0684
 24 cm 60°



DEBAKEY

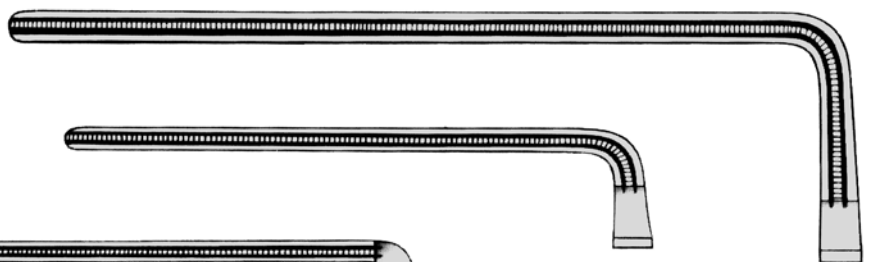

41.0696
 28 cm 90°

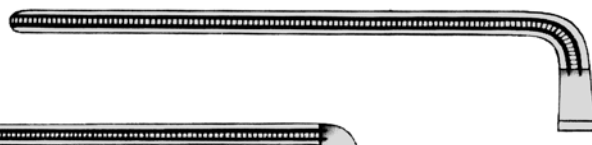

41.0694
 21 cm 90°



41.0692
 18 cm 90°



41.0690
 23 cm 90°

ATRAUMATISCHE GEFÄSSKLEMMEN
NON-TRAUMATIC VASCULAR CLAMPS
PINCES-CLAMPS VASCULAIRES ATRAUMATIQUES
PINZAS-CLAMPS VASCULARES ATRAUMATICAS
PINZE VASCOLARI CON STRIATURA ATRAUMATICA

Aorta-Klemmen
Aorta clamps
Pinces pour l'aorte
Pinzas para aorta
Pinze per aorta



DEBAKEY-MORRIS

Vena-Cava-Klemmen
Vena cava clamps
Pinces pour vena cava
Pinzas de vena cava
Pinze per vena cava



DEBAKEY-SATINSKY

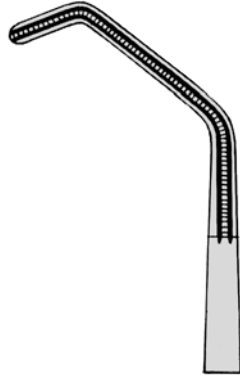

41.0825
23,5 cm

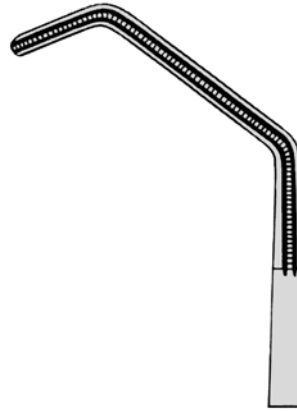

41.0826
24 cm

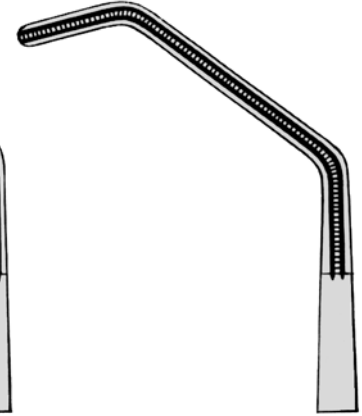

41.0827
24,5 cm

DEBAKEY-SATINSKY

41.0828

Klemmen Satz 41.0825-41.0827

Clamps Set 41.0825-41.0827

Jeu 41.0825-41.0827

Juego 41.0825-41.0827

Serie 41.0825 - 41.0827

ATRAUMATISCHE GEFÄSSKLEMMEN
NON-TRAUMATIC VASCULAR CLAMPS
PINCES-CLAMPS VASCULAIRES ATRAUMATIQUES
PINZAS-CLAMPS VASCULARES ATRAUMATICAS
PINZE VASCOLARI CON STRIATURA ATRAUMATICA

Thorax- und Aurikelklemmen
Thoracic and Auricle C lamps
Pinces thoraciques et auriculaires
Pinzas torácica y para la aurícula atril
Pinze per torace e ventricolari



41.0831
#1 25 cm



41.0832
#2 24 cm



DEBAKEY-HARKEN
24 cm

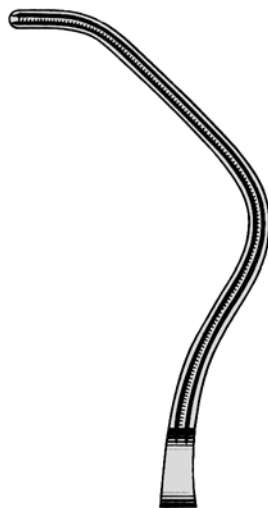

41.0833
#3 24 cm



41.0834
#4 24 cm

ATRAUMATISCHE GEFÄSSKLEMMEN
 NON-TRAUMATIC VASCULAR CLAMPS
 PINCES-CLAMPS VASCULAIRES ATRAUMATIQUES
 PINZAS-CLAMPS VASCULARES ATRAUMATICAS
 PINZE VASCOLARI CON STRIATURA ATRAUMATICA



DEBAKEY-BECK

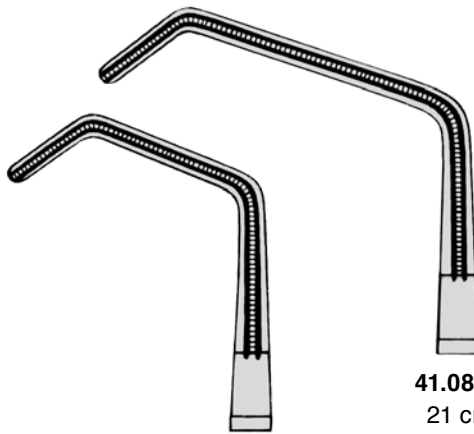

41.0886
19,5 cm

41.0887
21 cm

Vena-Cava-Klemmen
 Vena cava clamps
 Pincés pour vena cava
 Pinzas de vena cava
 Pinze per vena cava



GLOVER



41.0910
20,5 cm



41.0915
22 cm



41.0917
26 cm

Patent-Ductus-Klemmen
 Patent ductus clamps
 Pincés pour patent ductus
 Pinzas para conducto arterial
 Pinze per patent ductus



GLOVER



41.0911
20,5 cm

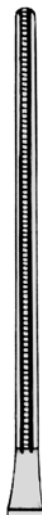

41.0916
22 cm

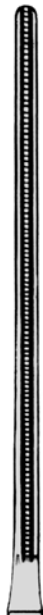

41.0918
25,5 cm



GLOVER



41.0912
21 cm



41.0913
22 cm

ATRAUMATISCHE GEFÄSSKLEMMEN
NON-TRAUMATIC VASCULAR CLAMPS
PINCES-CLAMPS VASCULAIRES ATRAUMATIQUES
PINZAS-CLAMPS VASCULARES ATRAUMATICAS
PINZE VASCOLARI CON STRIATURA ATRAUMATICA

Anastomosenklemmen
Anastomosis clamps
Pinces à anastomoses
Pinzas para anastomosis
Pinze per anastomosi



41.0930
21 cm

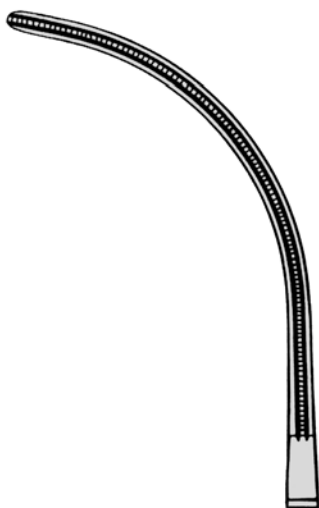

41.0932
24 cm

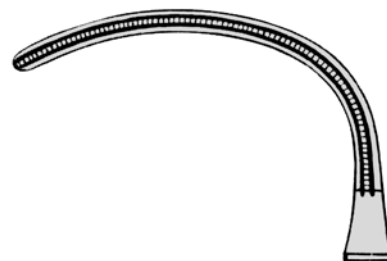

41.0940
18,5 cm



GLOVER

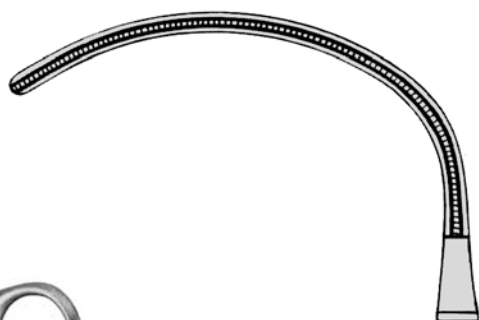

41.0942
22 cm



41.0945
21 cm



41.0947
26 cm

ATRAUMISCHE GEFÄSSKLEMMEN
NON-TRAUMATIC VASCULAR CLAMPS
PINCES-CLAMPS VASCULAIRES ATRAUMATIQUES
PINZAS-CLAMPS VASCULARES ATRAUMATICAS
PINZE VASCOLARI CON STRIATURA ATRAUMATICA



DEBAKEY



41.1160
21,5 cm



41.1162
23 cm



41.1164
27cm



41.1166
31,5 cm

Mehrzweckklemmen
 Multipurpose clamps
 Pinces polyvalants
 Pinzas para multiples aplicaciones
 Pinze per vari applicazione



DEBAKEY



41.1161
21,5 cm



41.1163
23 cm



41.1165
27 cm

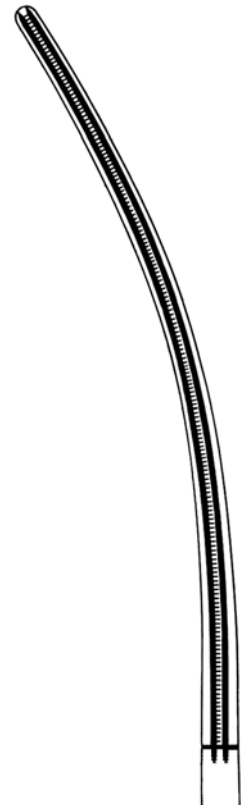

41.1167
31 cm

ATRAUMATISCHE GEFÄSSKLEMMEN
NON-TRAUMATIC VASCULAR CLAMPS
PINCES-CLAMPS VASCULAIRES ATRAUMATIQUES
PINZAS-CLAMPS VASCULARES ATRAUMATICAS
PINZE VASCOLARI CON STRIATURA ATRAUMATICA



DEBAKEY



41.1360
19 cm



41.1363
23 cm

Präparierklemmen
 Dissecting Forceps
 Pincès à disséquer
 Pinzas para disección
 Pinze per dissezione

Bronchusklemmen
 Bronchus Clamps
 Pincès-clamps pour bronches
 Pinzas para los bronquios
 Pinze per bronchi



LEES

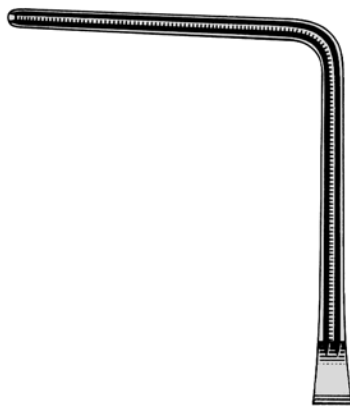

41.1370
23 cm 90°



LEES

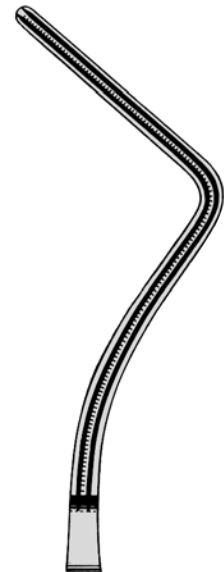

41.1372
25 cm

Mehrzweckklemmen
 Multipurpose clamps
 Pinces polyvalents
 Pinzas para multiples aplicaciones
 Pinze per vari applicazione

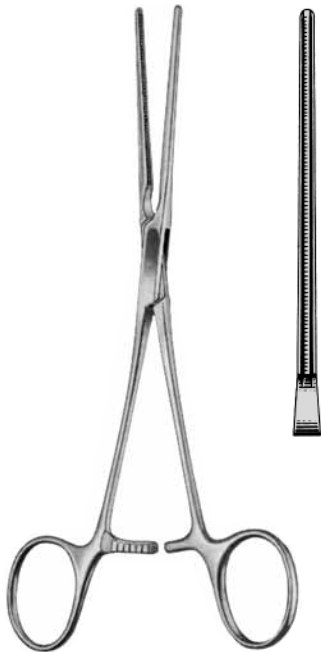

DEBAKEY
 41.1522 17 cm



DEBAKEY
 41.1523 16,5 cm



DEBAKEY-GLOVER
 41.1524 17 cm

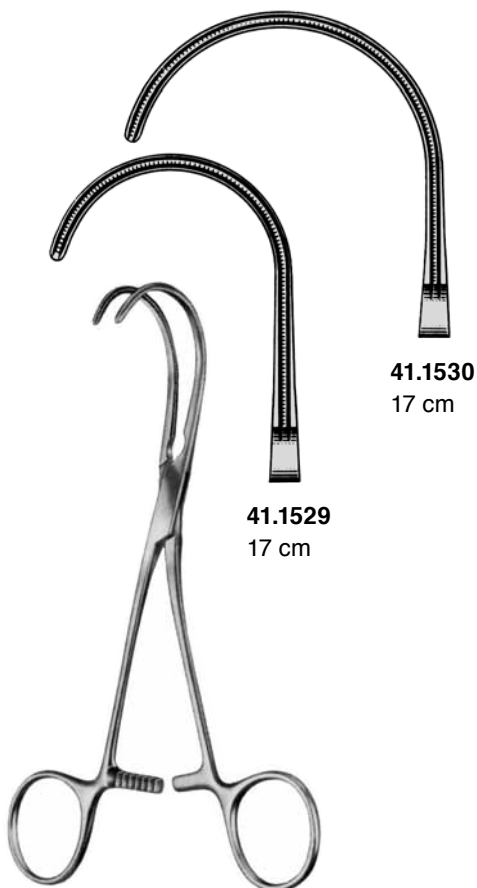

41.1529
 17 cm

DEBAKEY

41.1530
 17 cm



DEBAKEY

41.1535
 16 cm 30°



41.1537
 15,5 cm 45°



41.1539
 14 cm 90°

ATRAUMATISCHE GEFÄSSKLEMMEN
NON-TRAUMATIC VASCULAR CLAMPS
PINCES-CLAMPS VASCULAIRES ATRAUMATIQUES
PINZAS-CLAMPS VASCULARES ATRAUMATICAS
PINZE VASCOLARI CON STRIATURA ATRAUMATICA

Anastomosenklemmen
 Anastomosis clamps
 Pincès à anastomoses
 Pinzas para anastomosis
 Pinze per anastomosi



DEBAKEY-BECK
 41.1550 16 cm



DEBAKEY-GLOVER
 41.1555 17 cm

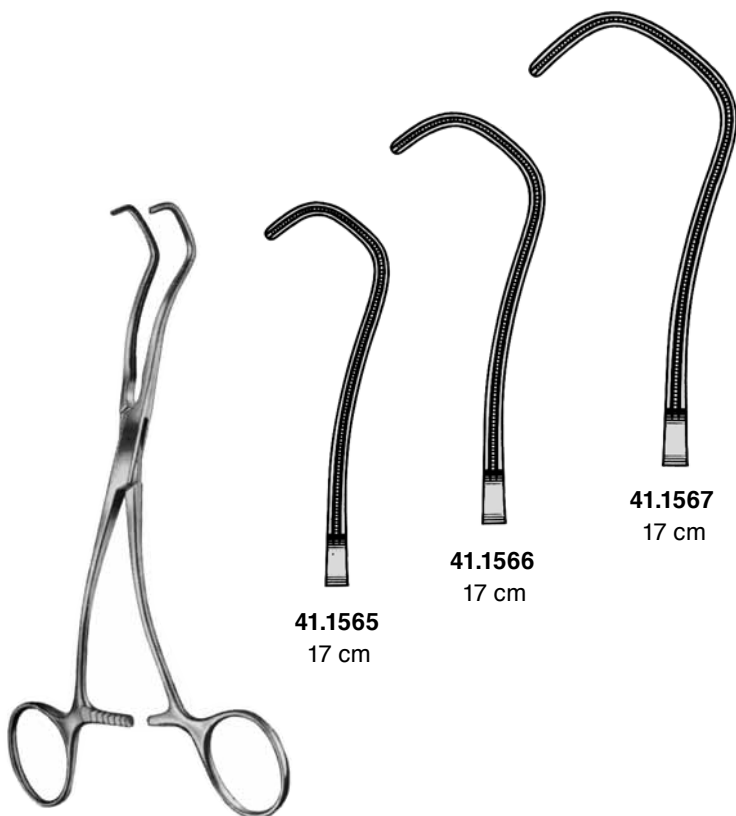

DEBAKEY-DERRA

41.1565
 17 cm

41.1566
 17 cm

41.1567
 17 cm

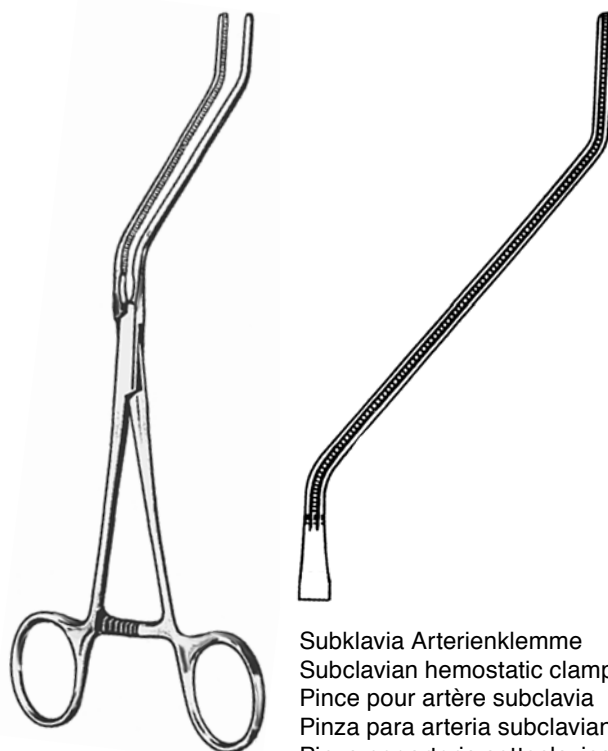

HENLY
 41.1571
 20 cm

Subklavia Arterienklemme
 Subclavian hemostatic clamp
 Pince pour artère subclavia
 Pinza para arteria subclaviana
 Pinza per arteria sottoclavicale

Anastomosenklemmen
Anastomosis clamps
Pinces à anastomoses
Pinzas para anastomosis
Pinze per anastomosi

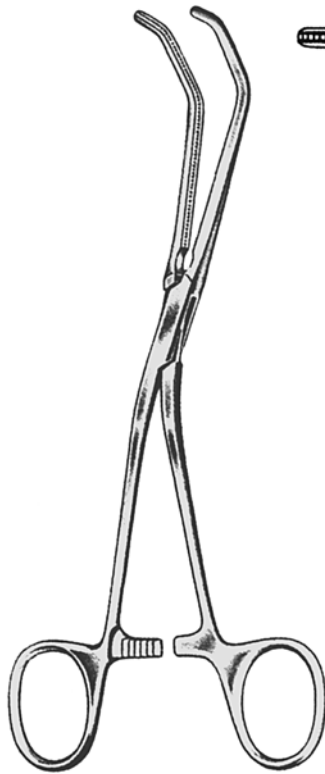

DEBAKEY-REYNOLDS

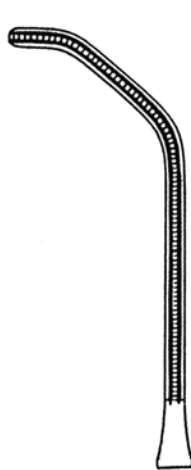

41.1580
18 cm

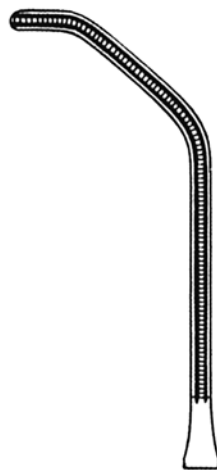

41.1581
18 cm



41.1585
16,5 cm

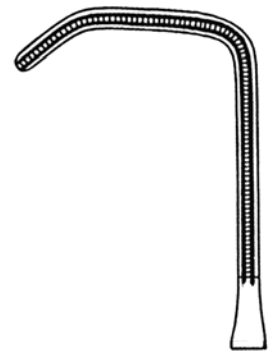

41.1586
16,5 cm



DEBAKEY-BECK

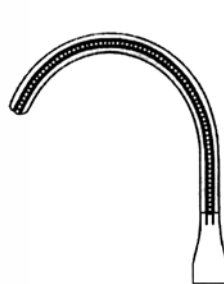

41.1590
15 cm

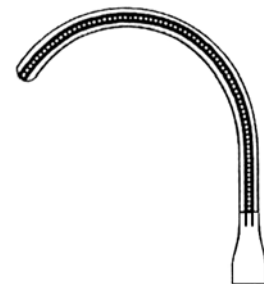

41.1591
15 cm

ATRAUMATISCHE GEFÄSSKLEMMEN
NON-TRAUMATIC VASCULAR CLAMPS
PINCES-CLAMPS VASCULAIRES ATRAUMATIQUES
PINZAS-CLAMPS VASCULARES ATRAUMATICAS
PINZE VASCOLARI CON STRIATURA ATRAUMATICA

Bauch-Aorta-Klemmen
Abdominal aorta clamps
Pinces pour l'aorte abdominale
Pinzas para aorta abdominal
Pinze per aorta addominale



DEBAKEY
41.1593
17 cm

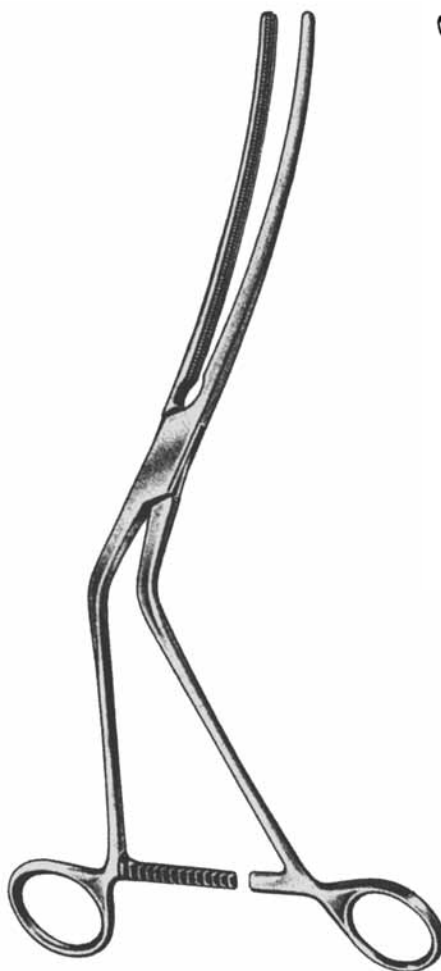

WYLIE



41.1657
27 cm

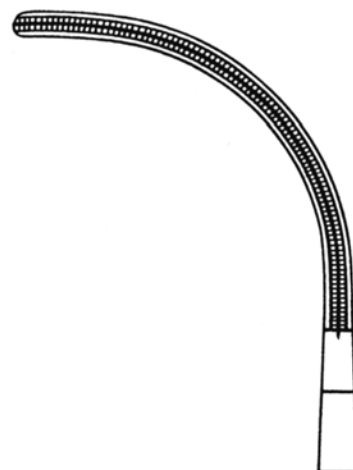

41.1658
26 cm



SATINSKY
40.0900
15 cm

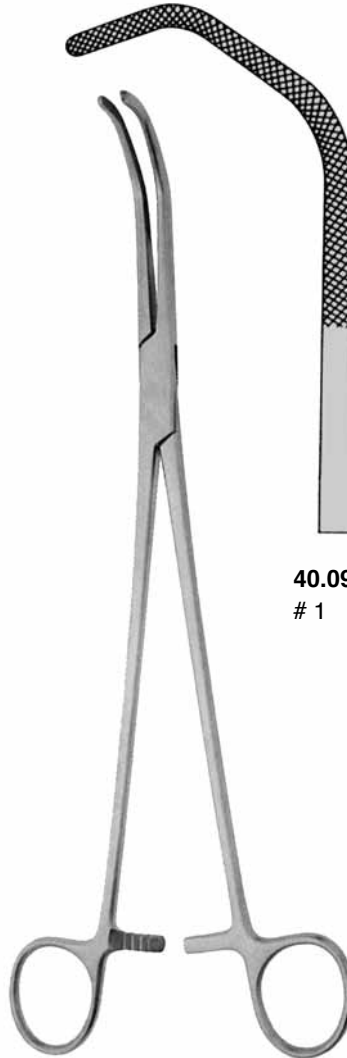

40.0902
1

SATINSKY
26 cm

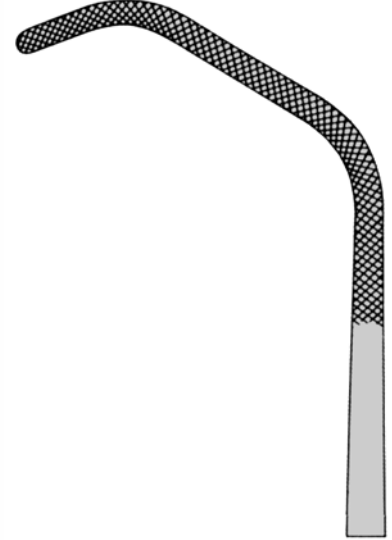

40.0904
2

