

KRANIO-MAXILLOFAZIALE CHIRURGIE  
CRANIO-MAXILLO-FACIAL SURGERY  
CHIRURGIE DU CRANE ET MAXILLO-FACIALE  
CIRUGIA CRANEO-MAXILOFACIAL  
CHIRURGIA CRANIO-MACILLO-FACCIALE

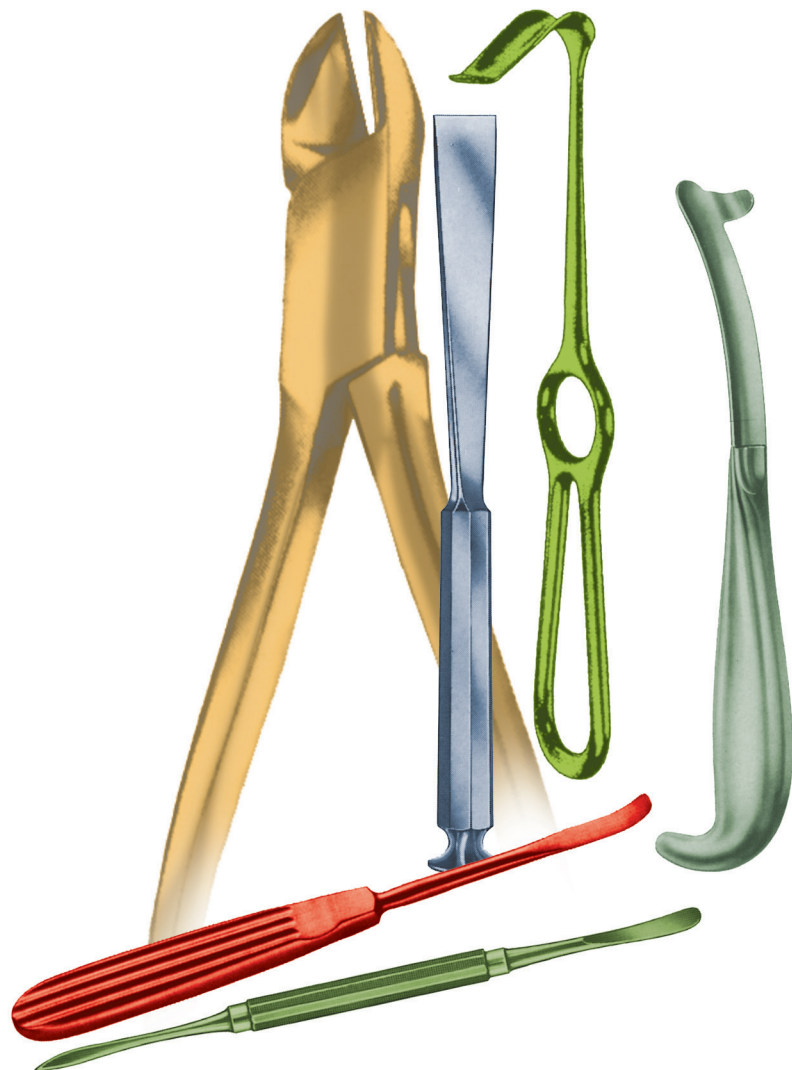

**WANGENHAKEN**  
**CHEEK RETRACTORS**  
**ECARTEURS A JOUWES**  
**SEPARADORES DE MEJILLAS**  
**SEPARATORI PER GUANCIA**



**34.0070**  
 19 cm



**34.4020**  
 40x12 mm



**34.4022**  
 55x14 mm



**DOCKHORN**  
 20 cm



**BÜCHS**  
**34.4030** 20,5 cm

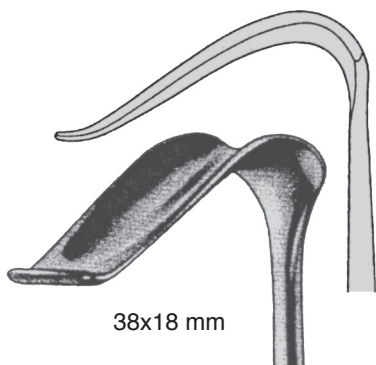

38x18 mm



**STEINHÄUSER**  
**34.4040** 24,5 cm



links  
 left  
 à gauche  
 izquierdo  
 sinistra

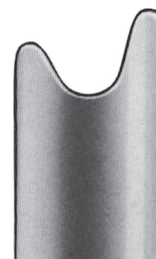

rechts  
 right  
 à droite  
 derecho  
 destra

Zygoma-Wundhaken  
 Zygomatic Retractor  
 Ecarteur cygomatique  
 Separador cigomático  
 Divaricatore per zigoma



**STEINHÄUSER**  
**34.4042** 24,5 cm

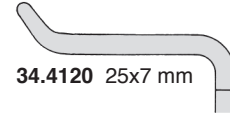
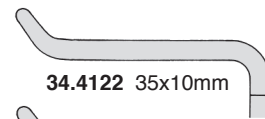
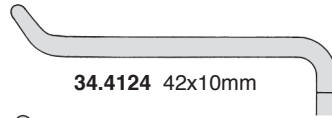
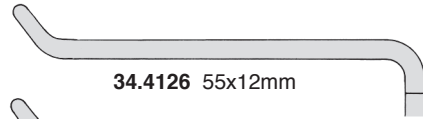
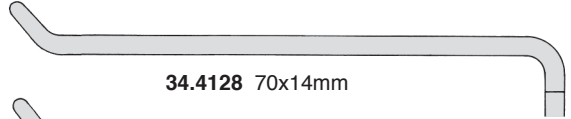
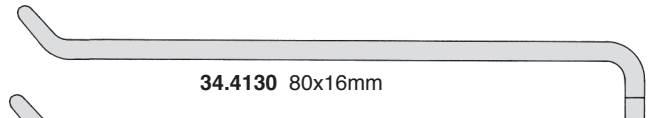
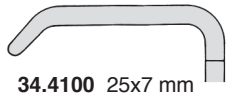
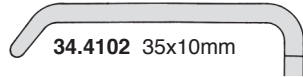
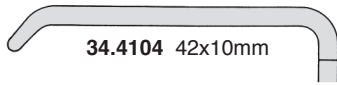
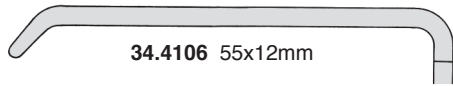
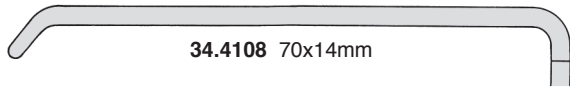
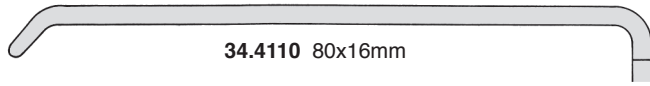

**OBWEGESER**  
34.4100-34.4110  
22 cm



**OBWEGESER**  
34.4120-34.4130  
22 cm

RAMUSHAKEN  
RAMUS RETRACTORS  
ECARTEURS POUR RAMUS  
SEPARADORES DE RAMA  
SEPARATORI PER RAMO

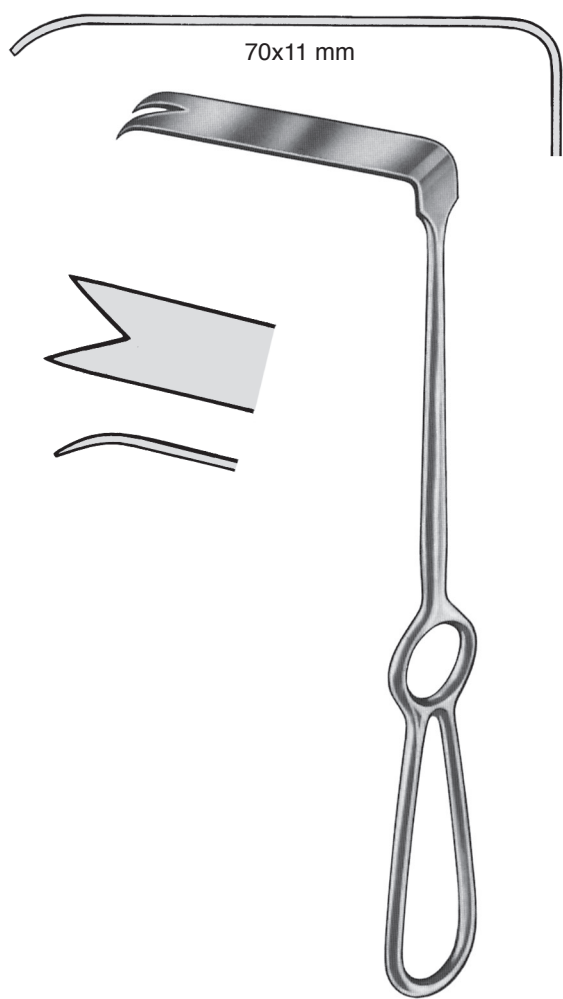

70x11 mm

**OBWEGESER**  
34.4140 22 cm

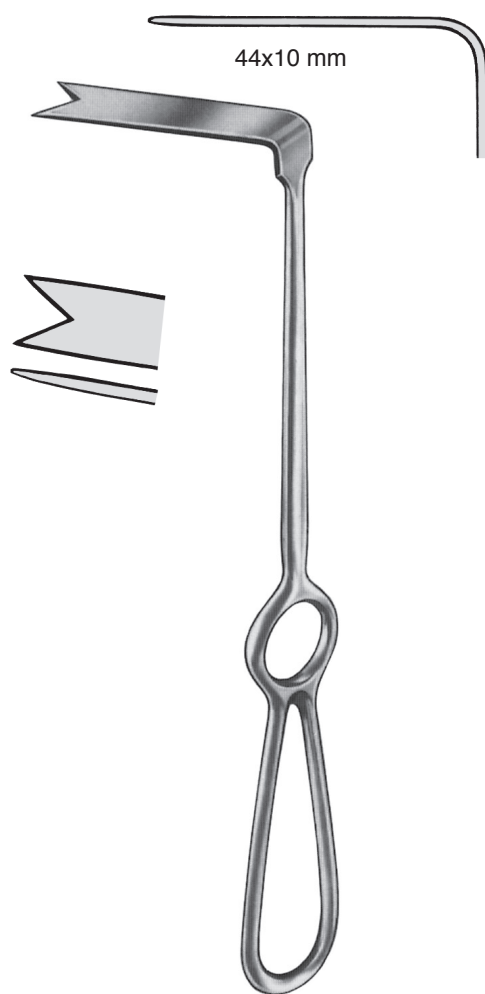

44x10 mm

**OBWEGESER**  
34.4145 22 cm

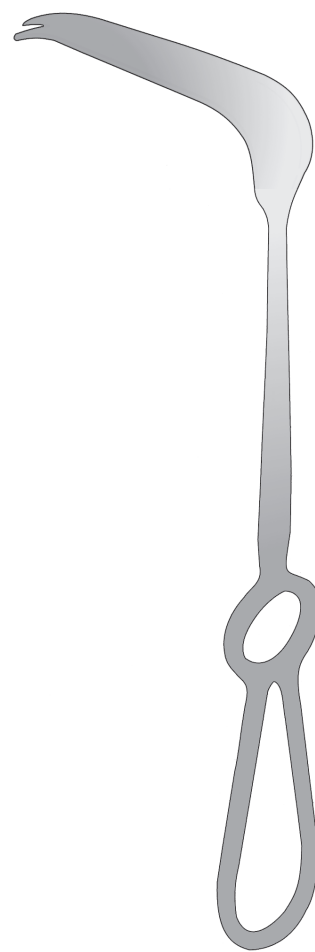

**OBWEGESER**  
22 cm  
34.3146  
11x15x70 mm  
34.4148  
12x22x70 mm

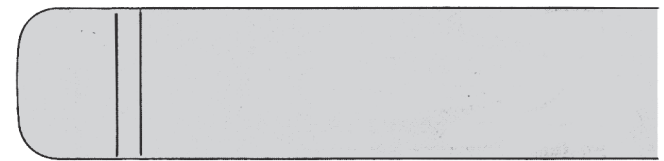
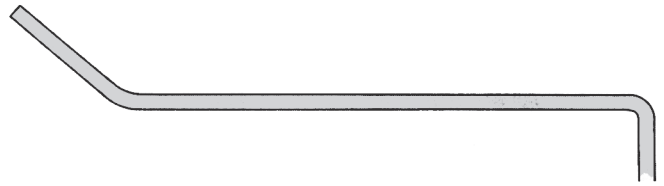

**34.4150**  
20 mm



**34.4152**  
25 mm



**34.4154**  
30 mm

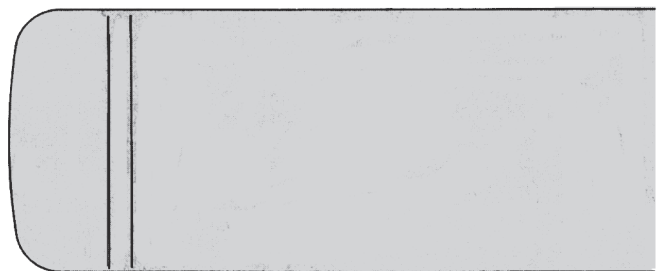

**34.4156**  
35 mm



**RAMUS**  
16 cm

Kinnhalter  
Chin Retractor  
Fixe-menton  
Gancho de mentón  
Guancio per mento



**OBWEGESER**  
34.4160  
15 cm

Progenierinnen  
Channel Retractors  
Ecarteurs mandibulaires  
Separadores mandibulares  
Separatori mandibolari



**OBWEGESER**  
34.4170 8 mm  
34.4172 10 mm  
16 cm

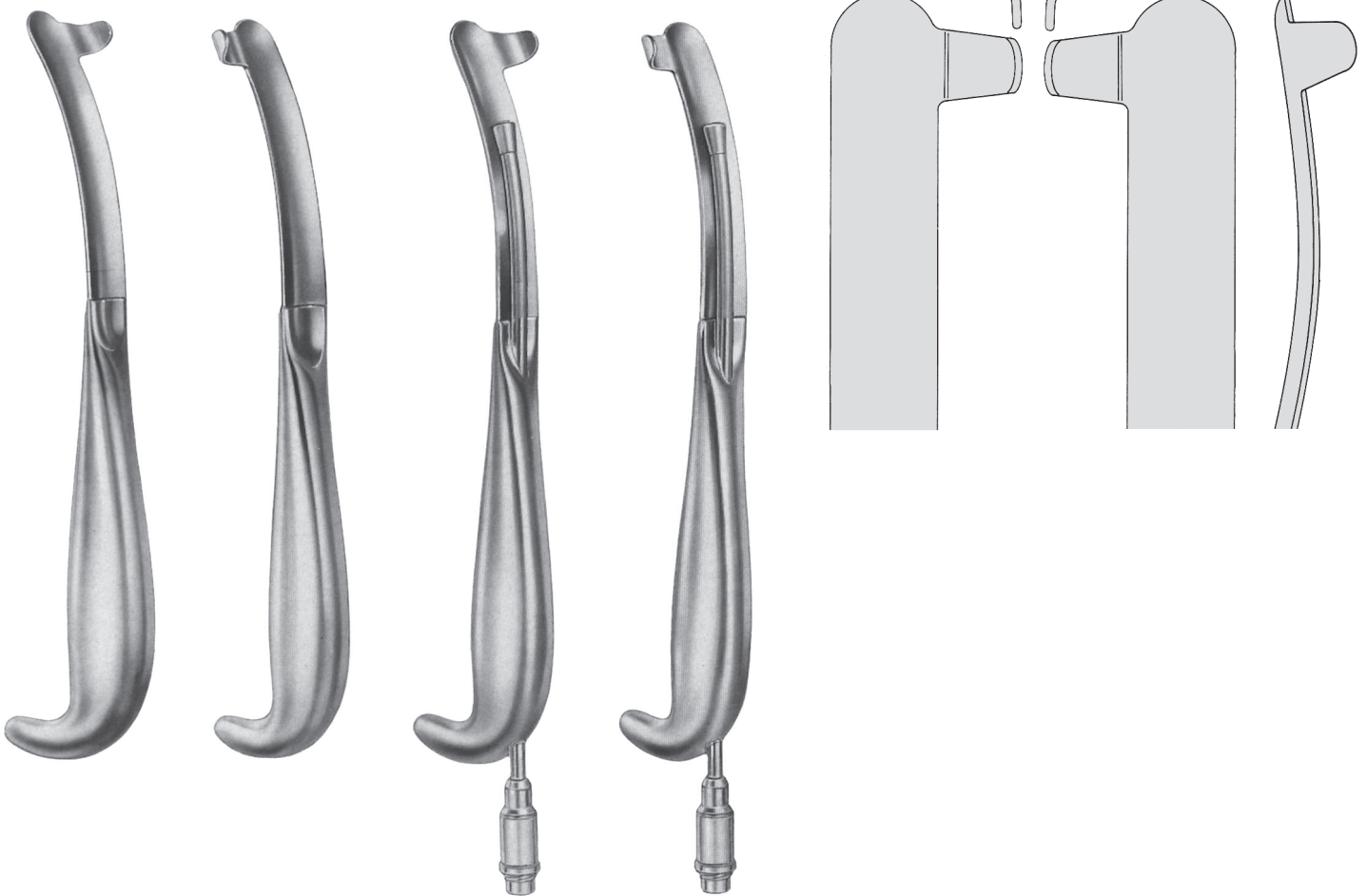

**BAUER**  
**34.4200**  
 21 cm  
 26 / 16 mm  
 rechts  
 right  
 à droite  
 derecha  
 destra

**BAUER**  
**34.4202**  
 21 cm  
 26 / 16 mm  
 links  
 left  
 à gauche  
 izquierda  
 sinistra

**BAUER**  
**34.4205**  
 21 cm  
 26 / 16 mm  
 rechts  
 right  
 à droite  
 derecha  
 destra

**BAUER**  
**34.4207**  
 21 cm  
 26 / 16 mm  
 links  
 left  
 à gauche  
 izquierda  
 sinistra

mit Kaltlichtaufsatz / with F.O. illumination /  
 avec support lumière froide /  
 con portador de luz fria / con luce fredda



**INTRA ORAL**  
**34.4220**  
24 cm  
25 mm

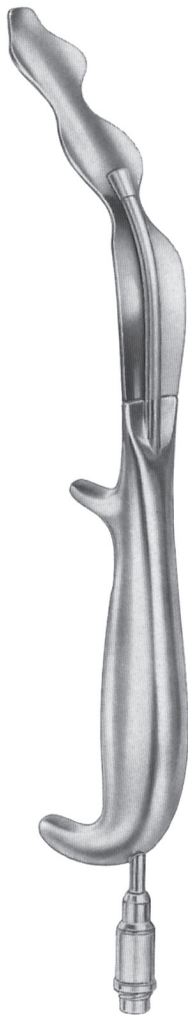

**INTRA ORAL**  
**34.4225**  
24 cm  
25 mm

mit Kaltlichtaufsatz  
with F.O. illumination  
avec support lumière froide  
con portador de luz fria  
con illuminazione alogena

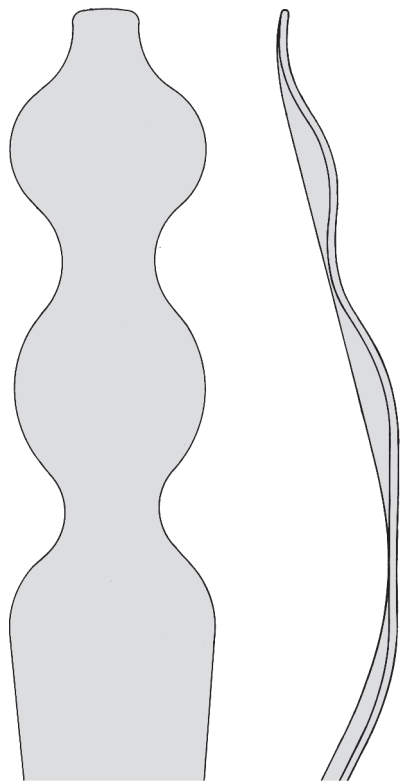





**EXTRA ORAL**  
**34.4210**  
24 cm  
9,5 / 16 mm

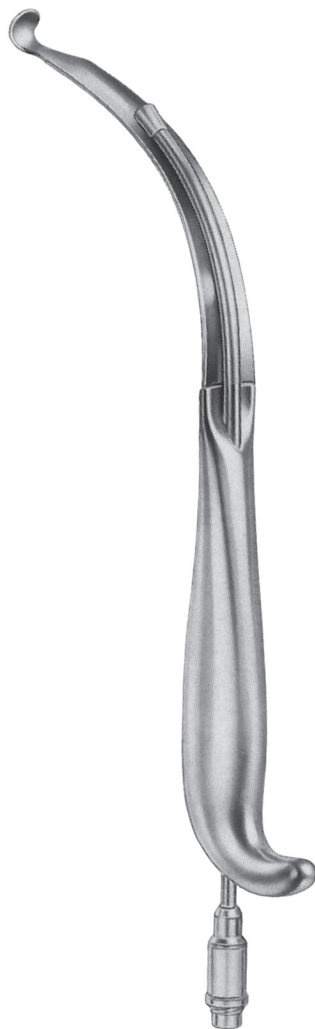

**EXTRA ORAL**  
**34.4215**  
24 cm  
9,5 / 16 mm  
mit Kaltlichtaufsatz  
with F.O. illumination  
avec support lumière froide  
con portador de luz fria  
con illuminazione alogena

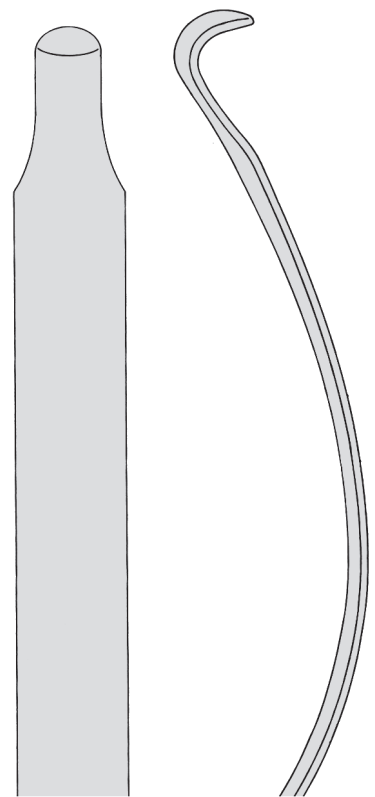

EXTRAORALE RETRAKTOREN  
 EXTRA-ORAL RETRACTORS  
 RETRACTEURS EXTRAORAUX  
 SEPARADORES EXTRA ORALES  
 SEPARATORI EXTRAORALI

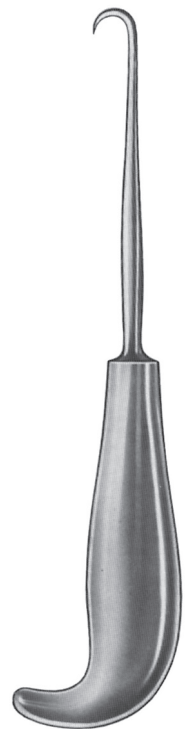
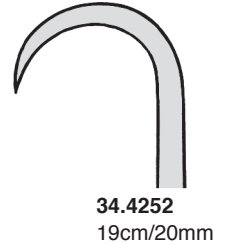
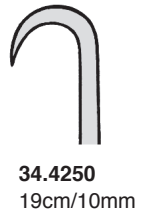
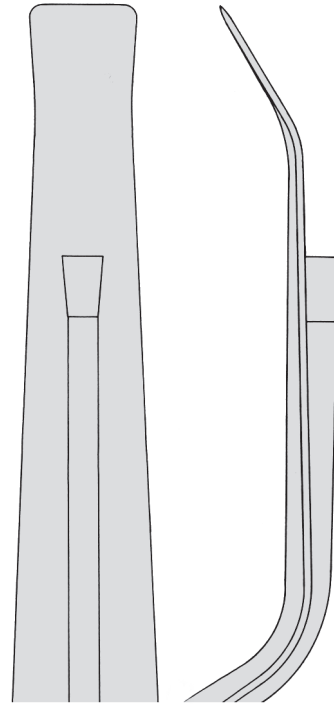
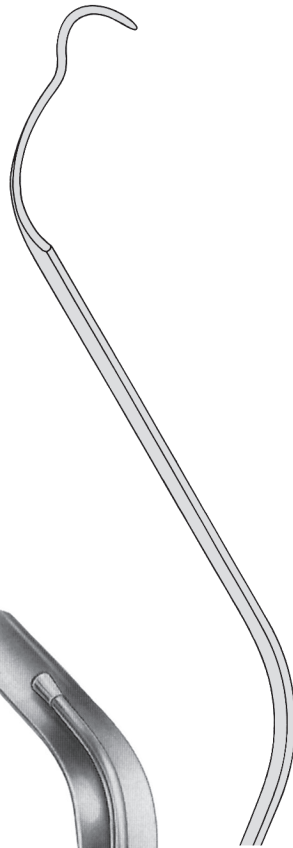
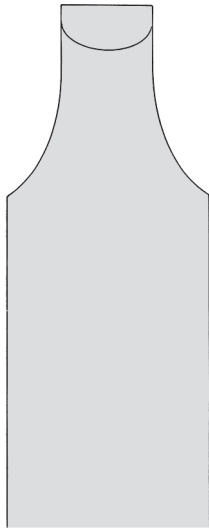

Mehrzweckhaken  
 Mult-purpose Retractor  
 Ecarteur à usage universelle  
 Separador de aplicaciones varias  
 Separatore multiuso

**DINGMANN**  
 Zygoma-Haken  
 Zygoma Hooks  
 Ecarteur zygomatiques  
 Ganchos zigomáticos  
 Divaricatori per zigoma

**LeVASSEUR-MERRILL**  
**34.4260** 25 cm  
 12,5 / 27 mm

**LeVASSEUR-MERRILL**  
**34.4265** 25 cm, 12,5 / 27 mm  
 mit Kaltlichtaufsatz  
 with F.O. illumination  
 avec support lumière froide  
 con portador de luz fria  
 con illuminazione alogena

**SHEA**  
**34.4275** 24 cm, 14,5 mm  
 mit Kaltlichtaufsatz  
 with F.O. illumination  
 avec support lumière froide  
 con portador de luz fria  
 con illuminazione alogena

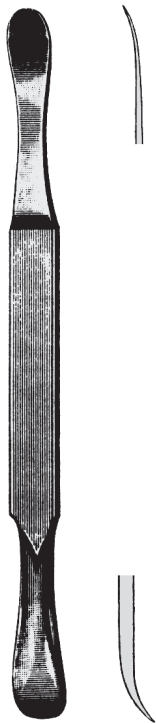

**SELDIN**  
**34.4300 #23**  
 19,5 cm



**GILLIES**  
**34.4310** 21 cm



**DINGMAN**  
**34.4320** 21 cm

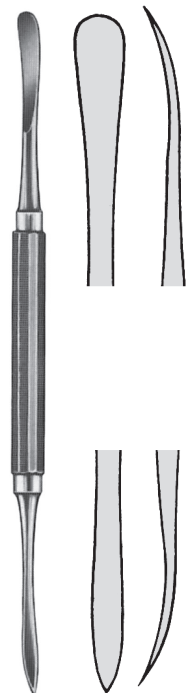

**DINGMAN**  
**34.4325** 18 cm

Kronendrucker  
 Band Pusher  
 Adapteur de couronnes  
 Empujador de coronas  
 Preminastro



**MERSHON**  
**34.4390** 14,5 cm

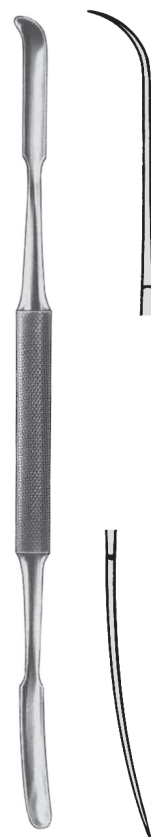

**OBWEGESER-FREER**  
**34.4561** 21 cm



**OBWEGESER-FREER**  
**34.4563** 21 cm

ELEVATOREN, RASPTOREN  
ELEVATORS, RASPATORIES  
ELEVATEURS, RUGINES  
ELEVADORES, PERIOSTOTOMOS  
ELEVATORI, PERIOSTOTOMI

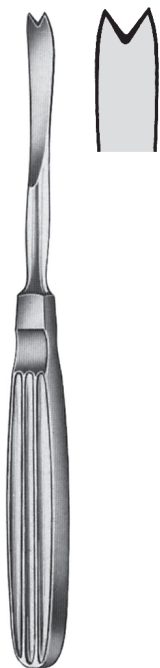

**OBWEGESER**  
34.4570 17,5 cm



**TESSIER**  
18 cm



**34.4501**  
6 mm  
30°

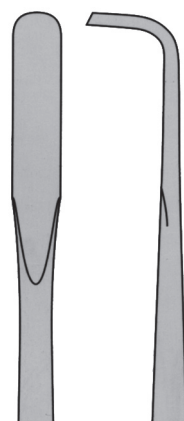

**34.4503**  
6 mm  
60°



**OBWEGESER**  
17,5 cm



**34.4506**  
6 mm



**34.4507**  
7 mm



**34.4509**  
9 mm

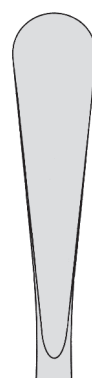

**34.4511**  
11 mm





**OBWEGESER**  
20 cm



**34.4525**  
5 mm



**34.4527**  
7 mm



**34.4529**  
9 mm

Gaumenspatelraspatorien  
Cleft-Palate Raspatories  
Raspatoires du palais  
Legras para paladar  
Periostotomi p.fessura del palato

rechts  
right  
droite  
derecha  
destra



**34.4540**  
14 cm



**34.4542**  
14 cm

links  
left  
gauche  
izquierda  
sinistra

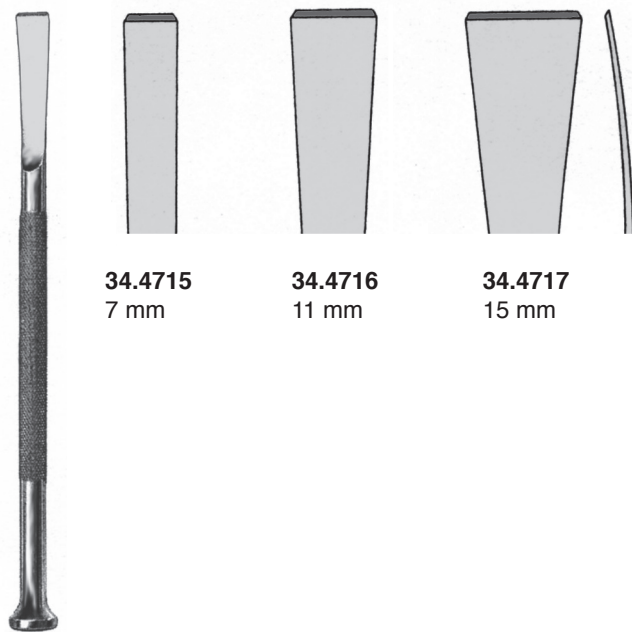

34.4715  
7 mm

34.4716  
11 mm

34.4717  
15 mm

**STEINHÄUSER**  
19 cm

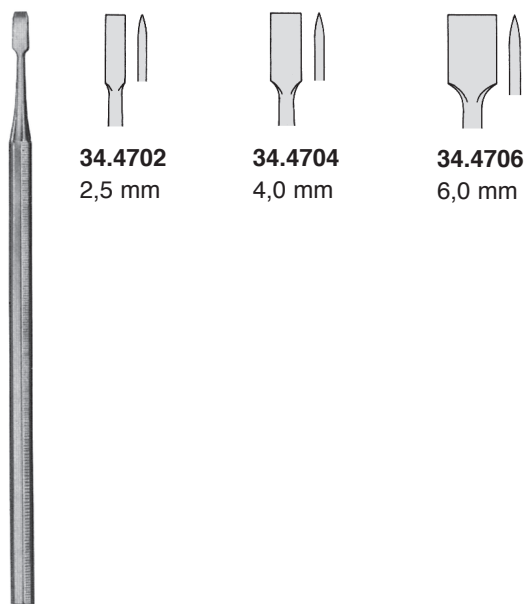

34.4702  
2,5 mm

34.4704  
4,0 mm

34.4706  
6,0 mm

**OSTEOTOM**  
15 cm

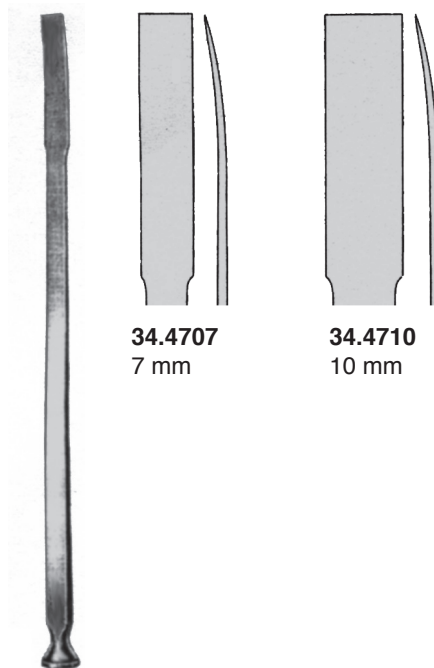

34.4707  
7 mm

34.4710  
10 mm

**STEINHÄUSER**  
17 cm



**OBWEGESER**  
 34.4730 18,5 cm



**OBWEGESER**  
 34.4743 18,5 cm



**OBWEGESER**  
 34.4750 23,5 cm



34.4760



34.4761

**TESSIER**  
 20 cm / 10 mm



**OBWEGESER**  
 34.4770  
 21 cm / 7 mm

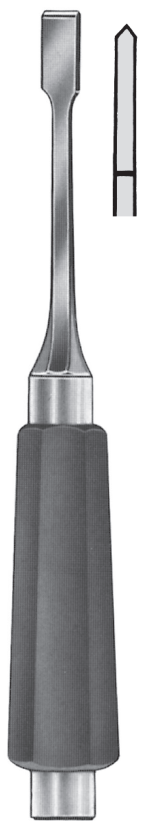

**OBWEGESER**  
 34.4772  
 21 cm / 10 mm



**OBWEGESER**  
 34.5000 14 cm



**KELSEY-FRY**  
 34.5010 15 cm



**KELSEY-FRY**  
 34.5012 18 cm



**34.5020**  
 18 cm



**OBWEGESER**  
 34.5030 23 cm

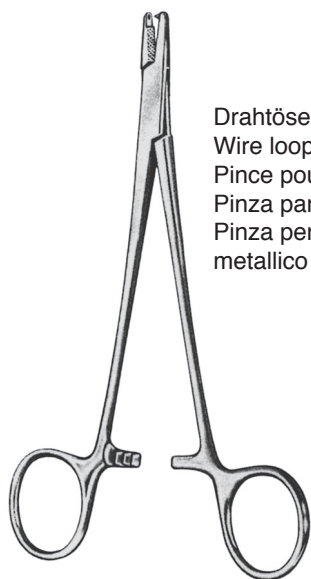

**OBWEGESER**  
 34.5100 15 cm

Drahtösenzange  
 Wire loop forceps  
 Pince pour anses  
 Pinza para ases  
 Pinza per ochiello in filo  
 metallico

Cerclagedraht  
 Bone wire  
 Fil d'acier  
 Hilo para huesos  
 Filo per ossa



**23.4004** 10 m / 0,4 mm  
**23.4005** 10 m / 0,5 mm



**23.4135** 14,5 cm





**ZIEGLER**  
 23.4170 18 cm



**MAYO-HABERISSER**  
 Drahtzwirbelzangen  
 Wire twisting forceps  
 Pinces serre-fil  
 Pinzas-tensoras de alambre  
 Pinzas tendifili d'acciaio



**23.4220**  
 15 cm



**23.4221**  
 15 cm

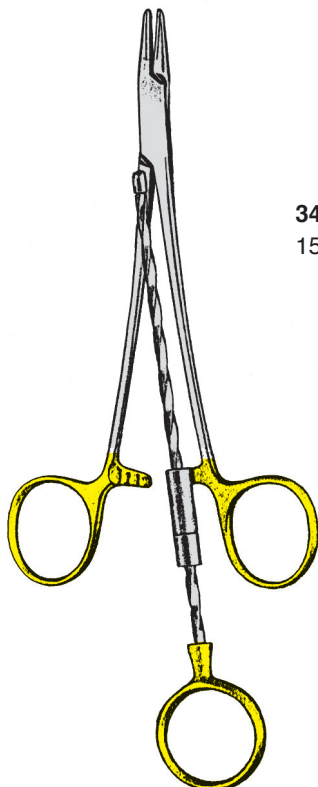

**34.5120**  
 15 cm



**34.5122**  
 15 cm



**34.5124**  
 15 cm



**34.5126**  
 18 cm



links  
left  
à gauche  
a izquierda  
sinistra

**TESSIER**  
**34.5200**  
15 cm



rechts  
right  
à droite  
a derecha  
destra

**TESSIER**  
**34.5202**  
15 cm

**PRO-MED** ist Ihnen behilflich bei der Zusammenstellung von Operationsbestecken für die verschiedensten Disziplinen. Fragen Sie nach unseren vorbereiteten OP-Bestecken.

For your convenience a wide variety of Suggested Operating Sets for most general and specialized procedures is available from **PRO-MED**. Please contact us or your local dealer.

**PRO-MED** vous propose de multiples compositions de boîtes opératoires multidisciplinaires. Demandez nos suggestions pour de nombreuses interventions.

**PRO-MED** le ayuda en componer varias cajas de instrumentos quirúrgicos. Pregunte por nuestro instrumental quirúrgico preparado.

Per la vostra comodità **PRO-MED** Vi aiuta nella raccolta di strumenti chirurgici per le varie discipline. Vi preghiamo di chiedere informazioni sui nostri set di strumenti chirurgici già preparati.

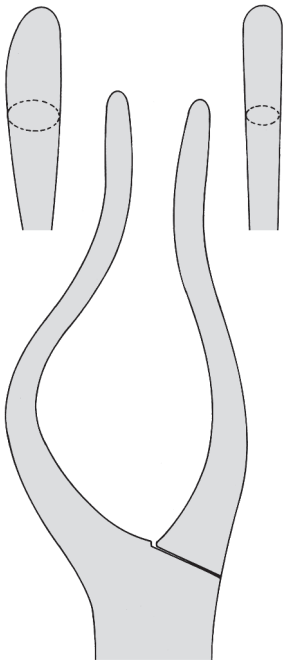

**34.5300L**  
**34.5310R**  
 für Säuglinge / Kleinkinder  
 for babies  
 pour nourissons  
 para lactantes  
 per lattanti

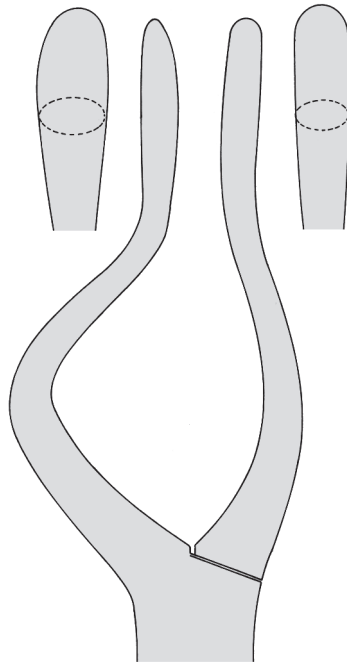

**34.5302L**  
**34.5312R**  
 für Kinder / Jugendliche  
 for children / juveniles  
 pour enfants / juvéniles  
 para niños / menors  
 per bambini

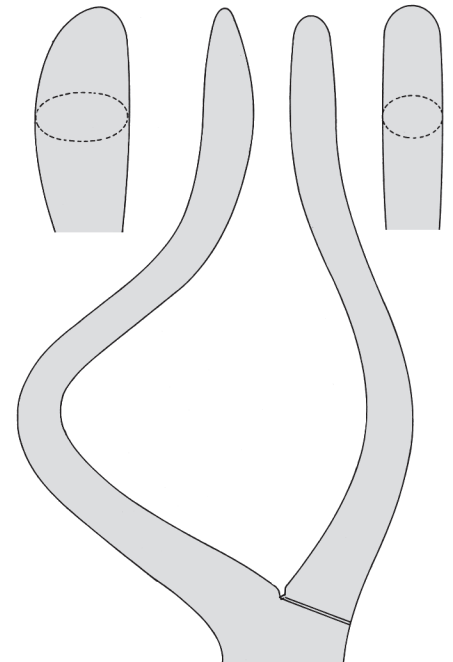

**34.5304L**  
**34.5314R**  
 für Erwachsene  
 for adults  
 pour adultes  
 para adultos  
 per adulti



Links  
 left  
 à gauche  
 a izquierda  
 sinistra

**ROWE**  
**34.5300 - 34.5304**



Rechts  
 right  
 à droite  
 a derecha  
 destra

**ROWE**  
**34.5310 - 34.5314**

