

KNOCHENCHIRURGIE
BONE SURGERY
CHIRURGIE OSSEUSE
CIRUGIA OSEA
CHIRURGIA OSSEA

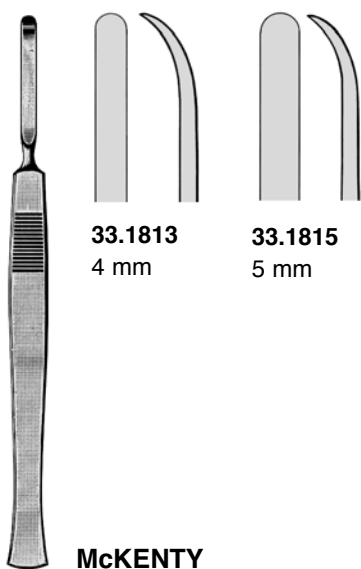

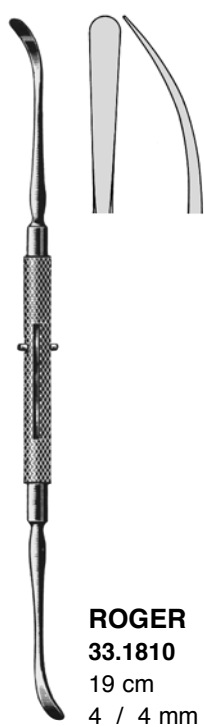

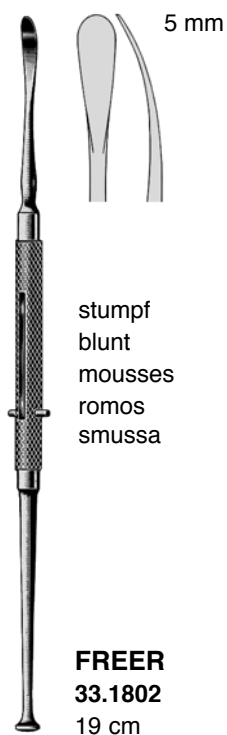

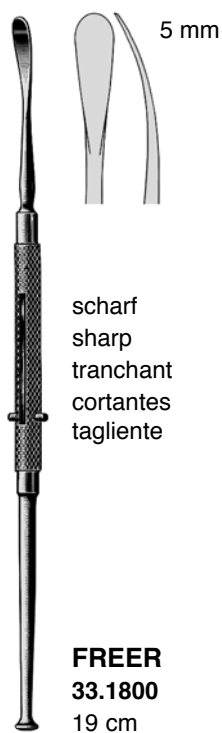

BALLENGER
 33.1820 19 cm
 6 / 6 mm



HAJEK-BALLENGER
 33.1830 19 cm
 33.1832 22 cm
 6 / 6 mm

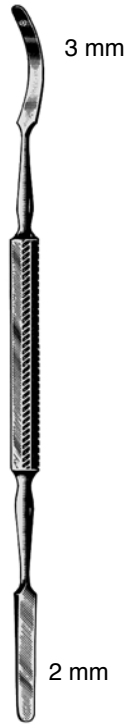

McDONALD
 33.1835 19 cm



WATSON-CHEYNE
 33.1836 17,5 cm



COTTLE
 33.1840 19 cm
 4 mm



MASING
 33.1842
 21 cm
 3 / 2 mm

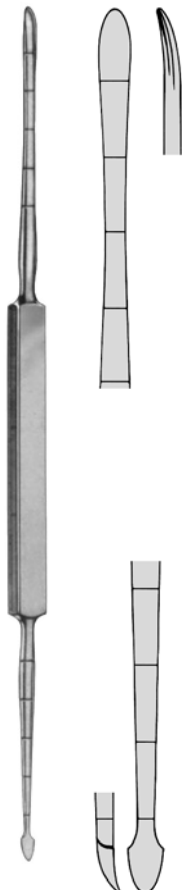

COTTLE
 33.1844
 23 cm
 4,5 / 4,5 mm

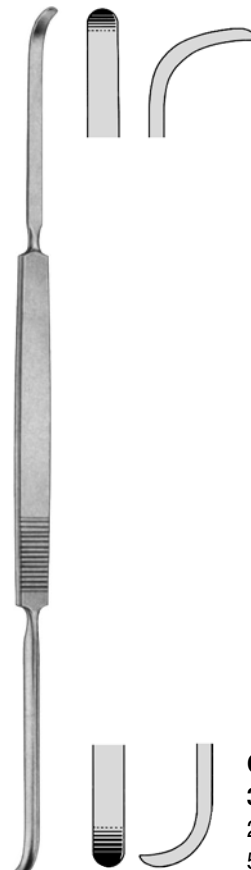

COTTLE
 33.1845
 22 cm
 5 / 5 mm



COTTLE
 33.1847
 18 cm,
 8 mm

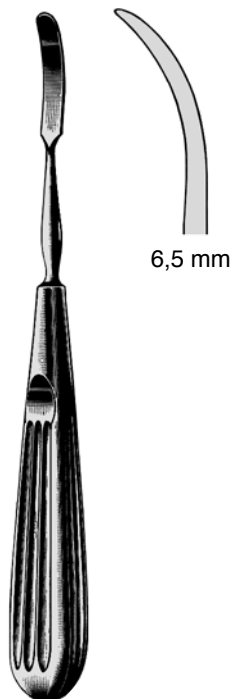

JOSEPH
33.1850 16 cm



JOSEPH-MASING
33.1853 22 cm



KILLIAN
33.1860 18 cm

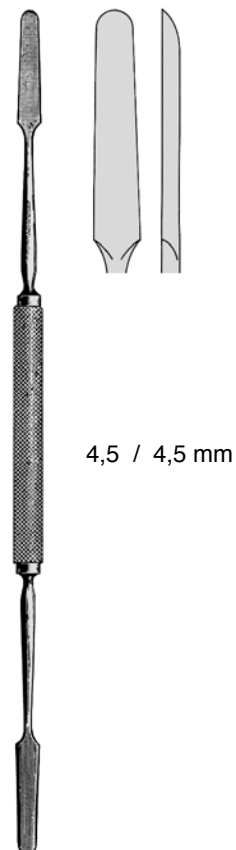

KILLIAN
33.1862 22 cm



HOWARTH (Burton)
33.1865 21,5 cm

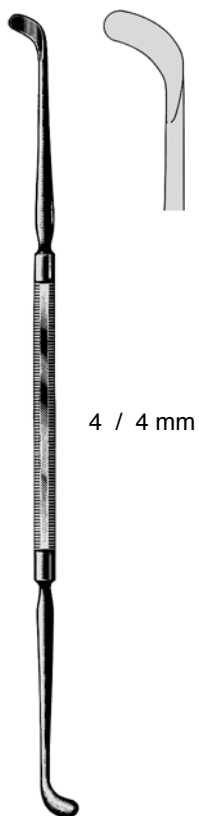

PENNINGTON
33.1870 21 cm

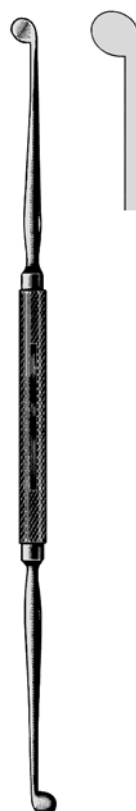

PIERCE
33.1875 21 cm



WATSON-CHEYNE
33.1866 12,5 cm
33.1867 19,0 cm



23.0010
 14 cm / 3 mm



23.0012
 15 cm / 5 mm



23.0014
 15 cm / 7 mm



23.0015
 12 cm / 16 mm



23.0016
 16 cm / 15 mm

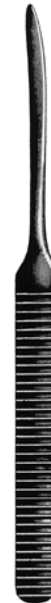

WILLIGER
23.0020
 16 cm / 5,5 mm



WILLIGER
23.0022
 17 cm / 7 mm



WALTON
23.0025 16 cm

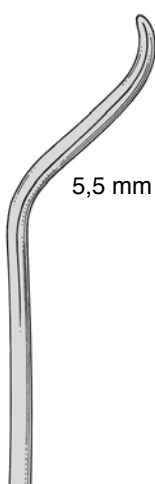

5,5 mm



KOENIG
23.0028 15 cm



4,5 mm



KOENIG
23.0029 15 cm



4,5 mm



SEBILEAU
23.0030
 17 cm / 5 mm

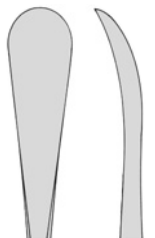

6 mm

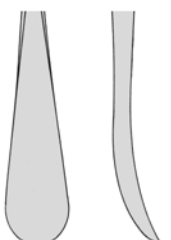

8 mm

ALDERDYCE
23.0036 21 cm

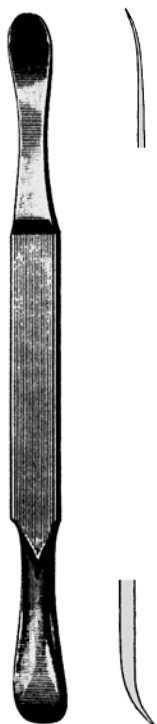

SELDIN
34.4300 #23
19,5 cm



GILLIES
34.4310 21 cm



DINGMAN
34.4325 18 cm

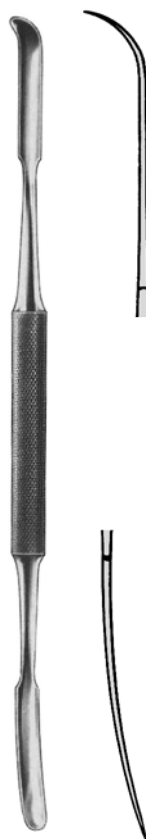

OBWEGESER-FREER
34.4561 21 cm



OBWEGESER-FREER
34.4563 21 cm



LANGENBECK

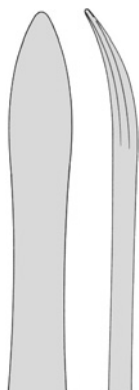

23.0050
20 cm / 8 mm



23.0052
20 cm / 10 mm

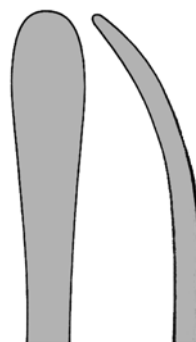

23.0054
23 cm / 11 mm



LANGENBECK

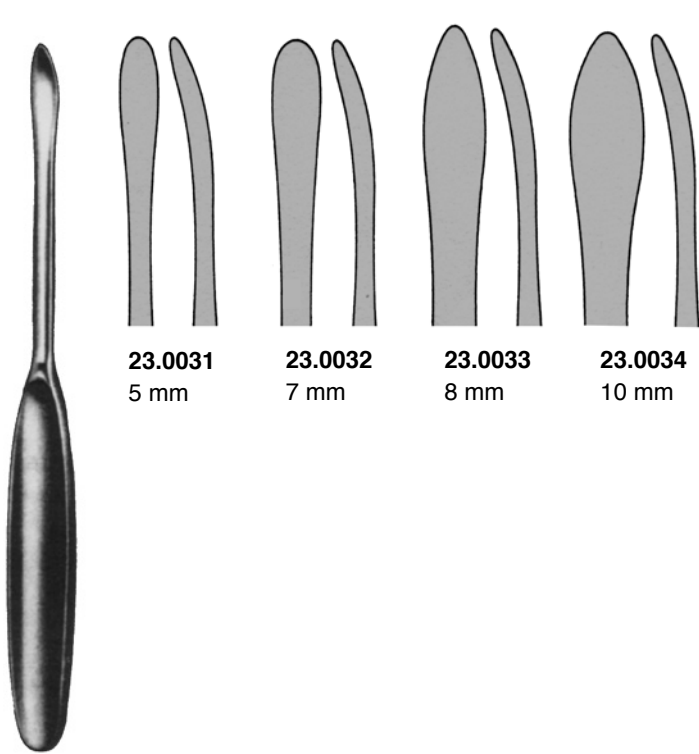

23.0031
5 mm

23.0032
7 mm

23.0033
8 mm

23.0034
10 mm

MARTIN-LANGENBECK
17 cm

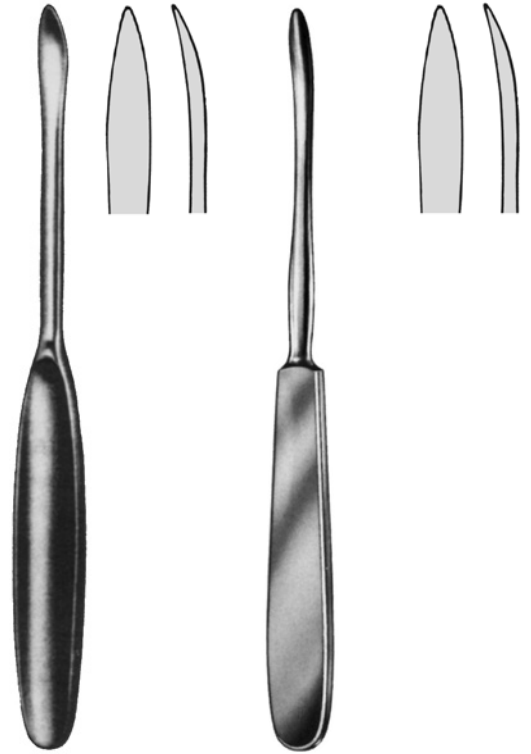

MARTIN-LANGENBECK
23.0035 20 cm / 6 mm

QUERVAIN
23.0060 20 cm / 6 mm

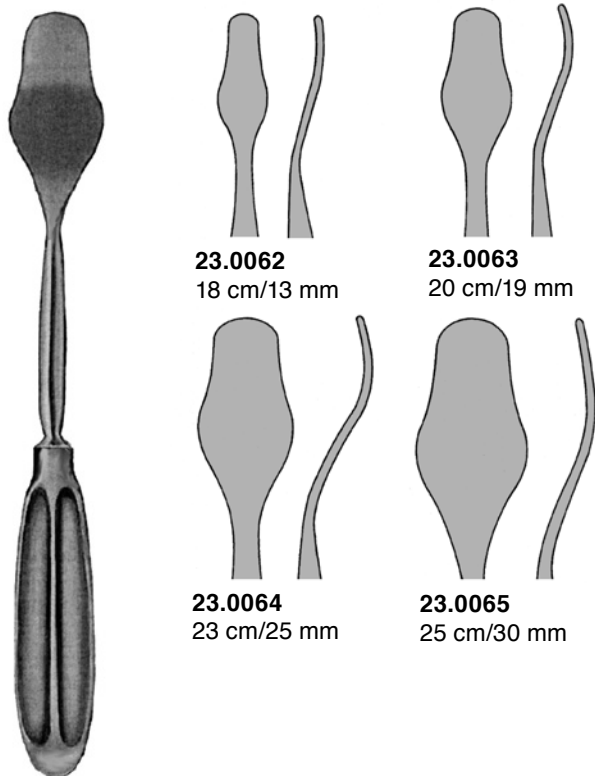

23.0062
18 cm/13 mm

23.0063
20 cm/19 mm

23.0064
23 cm/25 mm

23.0065
25 cm/30 mm

CHANDLER

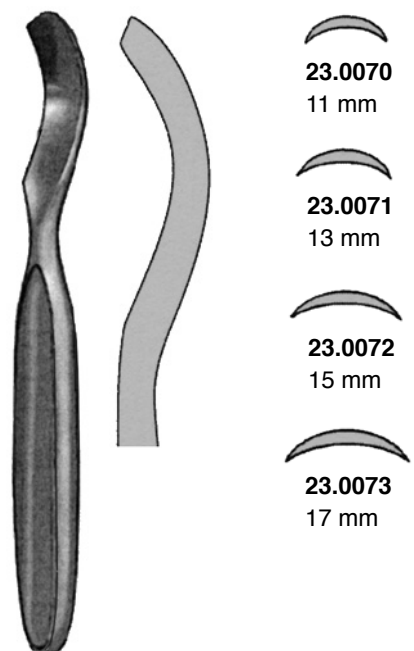

23.0070
11 mm

23.0071
13 mm

23.0072
15 mm

23.0073
17 mm

McGLAMRY
16,5 cm

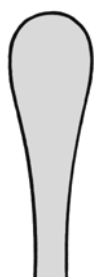

23.0080
10 mm

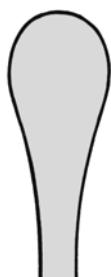

23.0081
13 mm



23.0082
19 mm



23.0083
25 mm

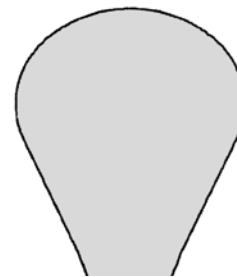

23.0084
32 mm

Griff - Handle - Manche - Mango - Manico
rostfrei - stainless - inoxydable - inoxidable - inossidabile



COBB
28 cm

23.0380
10 mm

23.0381
13 mm

23.0382
19 mm

23.0383
25 mm

23.0384
32 mm

Griff - Handle - Manche - Mango - Manico
Aluminium - aluminum - aluminium - aluminio alluminio



KEY

23.0090 17 cm / 3 mm

23.0091 17 cm / 6 mm

23.0092 17 cm / 9 mm

23.0093 17 cm / 12 mm

23.0094 19 cm / 19 mm

23.0095 19 cm / 25 mm

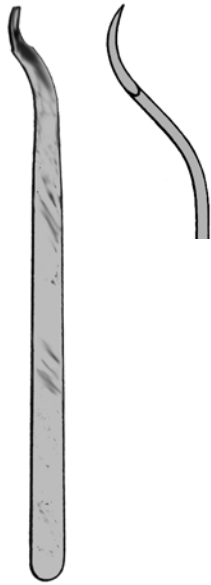

BUCK-GRAMCKO
 23.0199
 15 cm / 7,5 mm



HOHMANN-MINI
 16 cm



23.0200
 6 mm

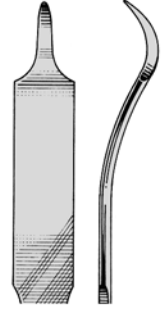

23.0201
 8 mm

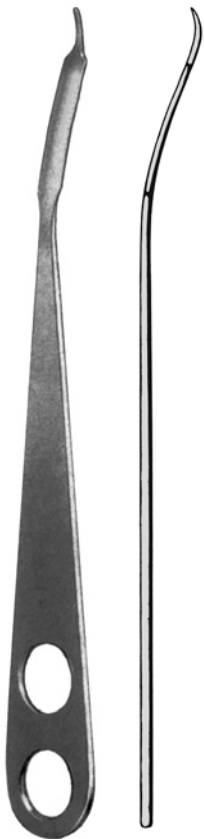

HOHMANN
 23.0202
 22 cm / 8 mm

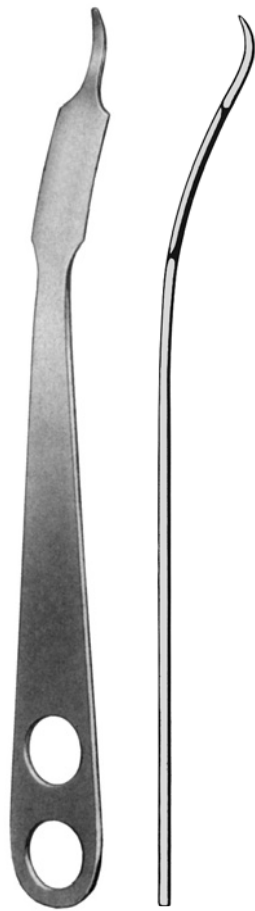

HOHMANN
 23.0203
 22 cm / 17 mm

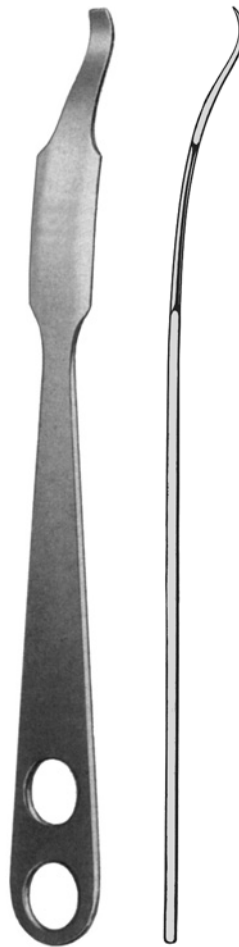

HOHMANN
 23.0204
 26 cm / 24 mm



HOHMANN
 23.0205
 28,5 cm / 34 mm



HOHMANN
23.0210
24 cm / 42 mm



HOHMANN
23.0212
24 cm / 65 mm

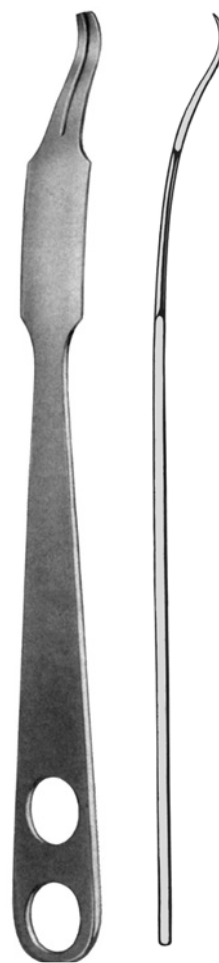

HOHMANN
23.0214
26 cm / 22 mm



HOHMANN
23.0220
24 cm / 43 mm



HOHMANN-ALDINGER
23.0225
27 cm / 24 mm



BLOUNT
23.0245
26 cm #1

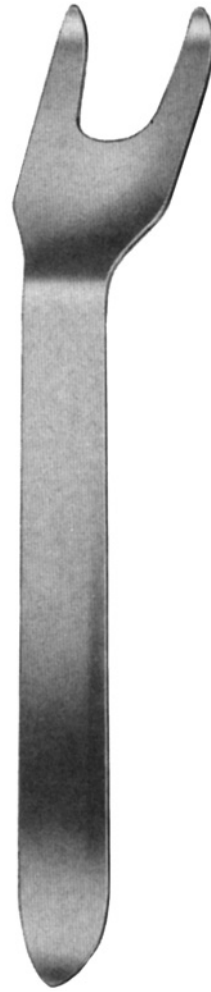

BLOUNT
23.0246
26 cm #2



23.0250
27 cm 24 mm / 13 mm

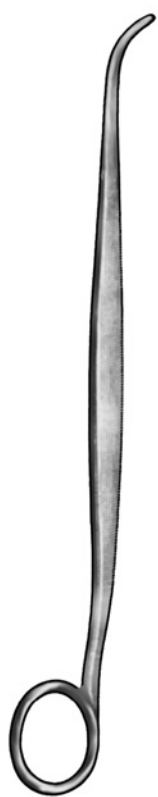

LANE-TRETHOWAN
23.0330
21,5 cm

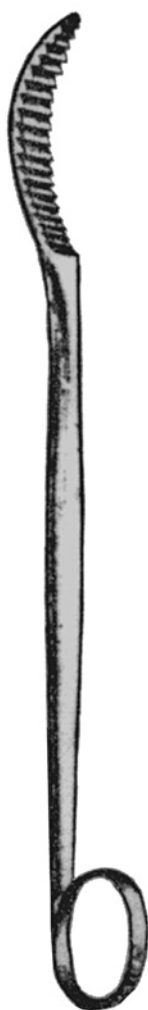

LANE
23.0332
25 cm



BRISTOW
23.0334
23 cm



WATSON-JONES
23.0338
28 cm



23 cm

Knochenhaken
 Bone hooks
 Ecarteurs pour os
 Separadores para huesos
 Divaricatori per osse



23.0251 6x10mm

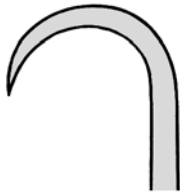

23.0252 11x18mm

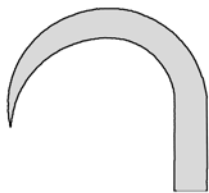

23.0253 12x21mm



MURPHY-LANE

23.0350

30 cm

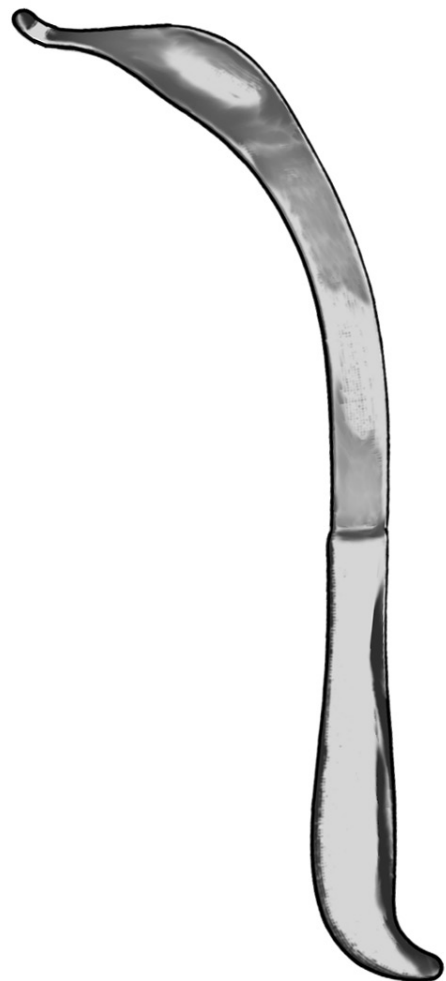

AUFRANC

23.0360 spitz gerieft/sharp serrated/
 pointu striée/agudo estriado/ acuto con striatura

23.0361 spitz glatt/sharp smooth/
 pointu lisse/agudo liso/ acuto liscio

23.0362 stumpf gerieft/blunt serrated/
 mousse striée/romo estriado/ tronco con striatura

23.0363 stumpf glatt/blunt smooth/
 mousse lisse/romo liso/tronco liscio

26 cm / 32 mm

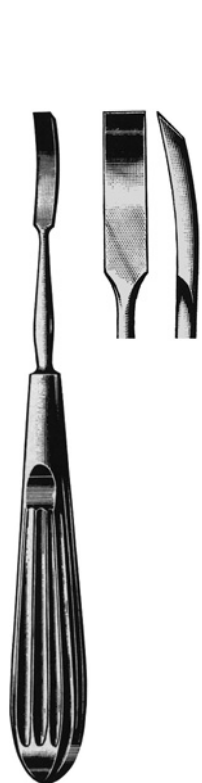

LEMPERT
32.1530
 18 cm

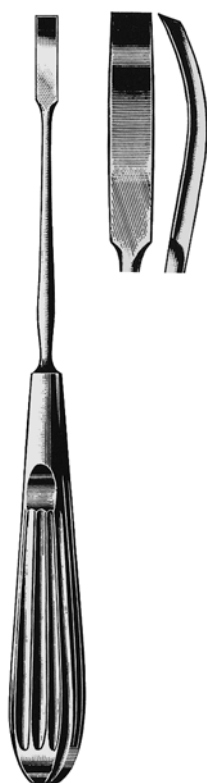

LEMPERT
32.1531
 20 cm



LEMPERT
 17 cm



32.1532
 2 mm



32.1533
 3 mm



32.1534
 4 mm



32.1535
 5 mm



32.1537
 3,5 mm



TESSIER
 18 cm



34.4501
 6 mm
 30°

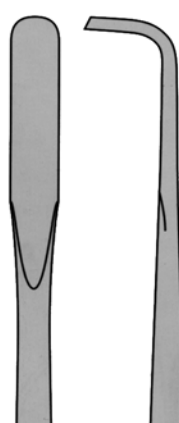

34.4503
 6 mm
 60°



OBWEGESER
17,5 cm



34.4506
6 mm



34.4507
7 mm



34.4509
9 mm

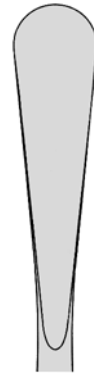

34.4511
11 mm



OBWEGESER
20 cm



34.4525
5 mm



34.4527
7 mm



34.4529
9 mm

mit Ferrozellgriff
with artificial wood-handles
avec manches en bois artificiel
con mangos de madera artificial
con manici in plastica

RASPATORIEN
RASPATORIES
RUGINES
LEGRAS
PERIOSTOTOMI



RASPATORIUM
23.0417
19 cm / 3 mm



RASPATORIUM
23.0418
19 cm / 6 mm



RASPATORIUM
23.0419
19 cm / 6 mm



RASPATORIUM
23.0421
19 cm / 6 mm

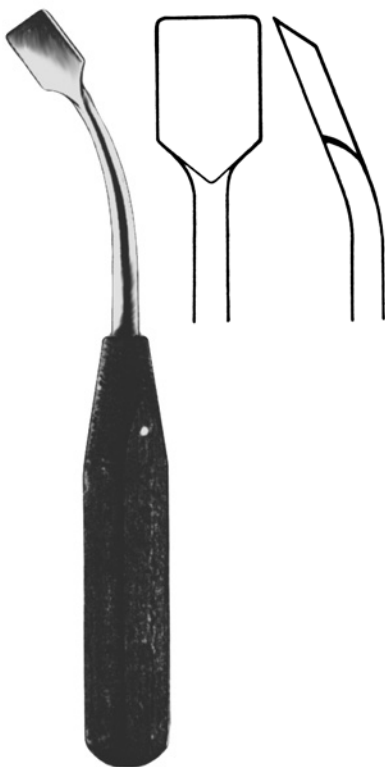

RASPATORIUM
23.0423
19 cm / 13 mm



RASPATORIUM
23.0424
19 cm / 14 mm

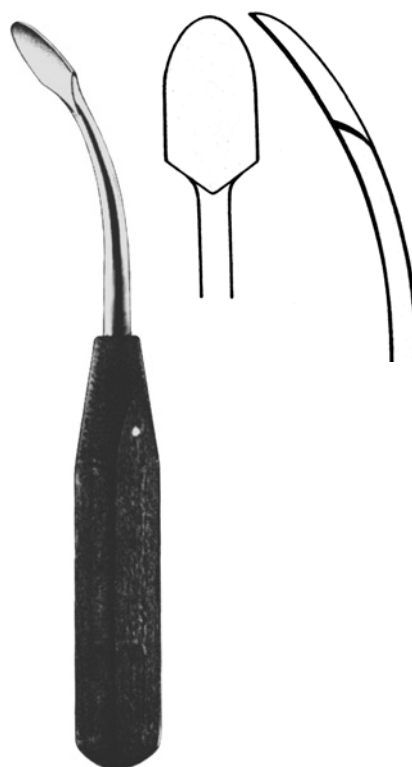

RASPATORIUM
23.0425
19 cm / 14 mm

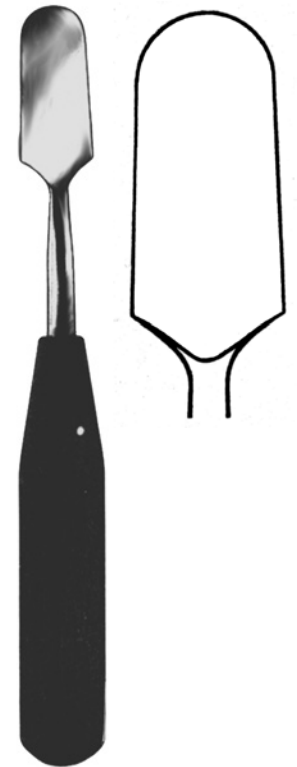

RASPATORIUM
23.0426
20 cm / 20 mm

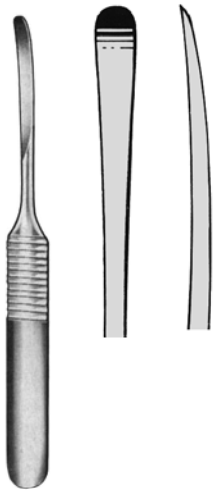

WILLIGER
23.0500
 13 cm / 5 mm



WILLIGER
23.0502
 16 cm / 5 mm



WILLIGER
23.0503
 16 cm / 7 mm

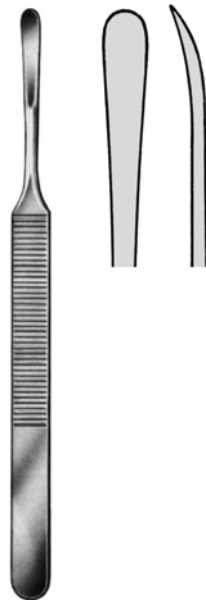

KOENIG
23.0505
 15,5 cm / 5 mm

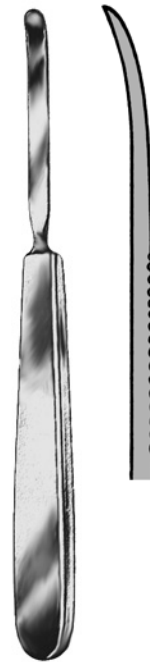

RASPATORIUM
 17 cm

23.0506
 6 mm

23.0508
 8 mm



SEWALL
23.0510
 20 cm / 6 mm



23.0515
 16 cm / 5 mm



23.0516
 16 cm / 6 mm



23.0517
 16 cm / 7 mm



23.0511
 16 cm / 4 mm



23.0512
 16 cm / 5 mm

KAHRE-WILLIGER

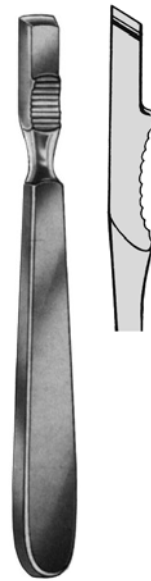

FARABEUF
23.0520
 15 cm / 13 mm



FARABEUF
23.0521
 15 cm / 13 mm

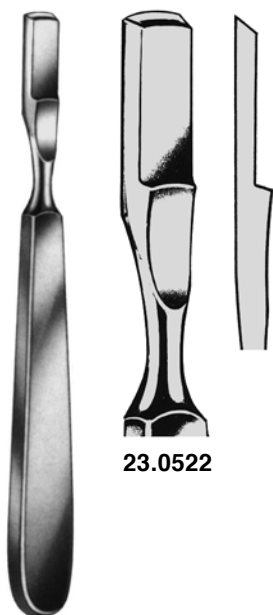

FARABEUF-COLLIN
15,5 cm / 11 mm

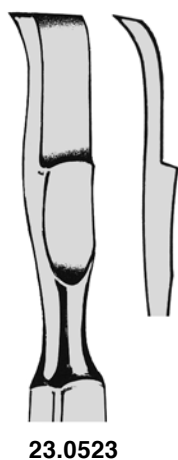

FARABEUF
23.0524
19 cm

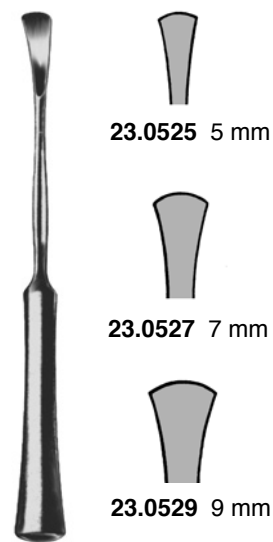

HYLIN
14,5 cm



LANGENBECK
23.0530
19 cm / 16 mm

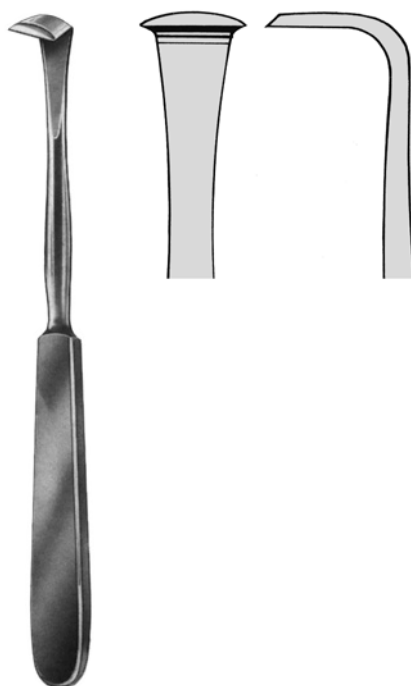

LANGENBECK
23.0531 19 cm



PENNYBAKER
23.0535
16,5 cm / 6 mm



JANSEN
 23.0536
 16,5 cm / 15 mm



LAMBOTTE



23.0540 5 mm
 23.0542 10 mm
 23.0544 15 mm
 23.0546 20 mm
 23.0548 25 mm

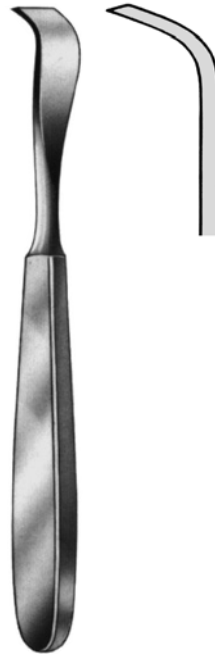

SCHNEIDER
 23.0550
 17,5 cm / 13 mm



SCHNEIDER-SAUERBRUCH
 23.0552
 19 cm

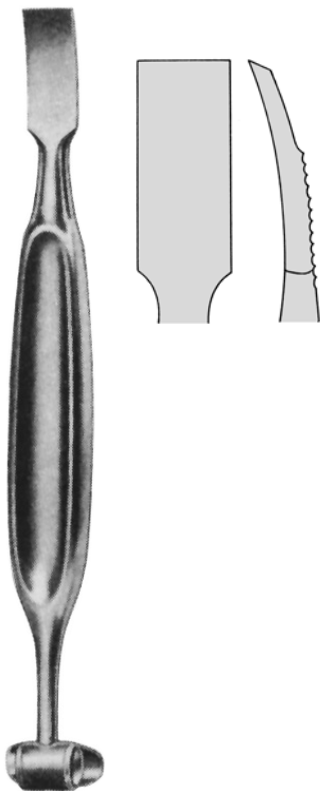

ALEXANDER
 23.0560
 21 cm

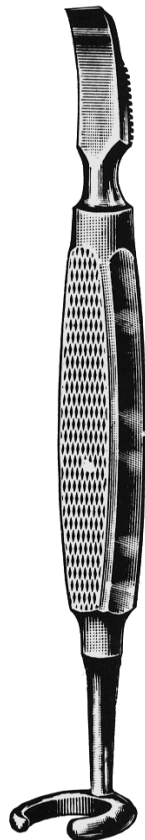

MATSON-ALEXANDER
 23.0562
 22 cm

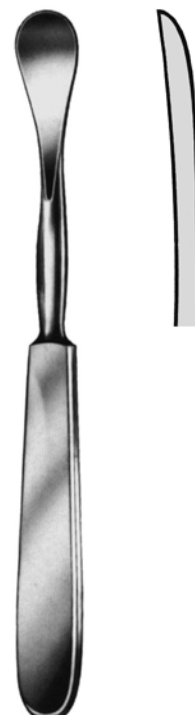

SEDILLOT
 23.0570
 18 cm / 18 mm



SEDILLOT
 23.0575
 21 cm / 15 mm

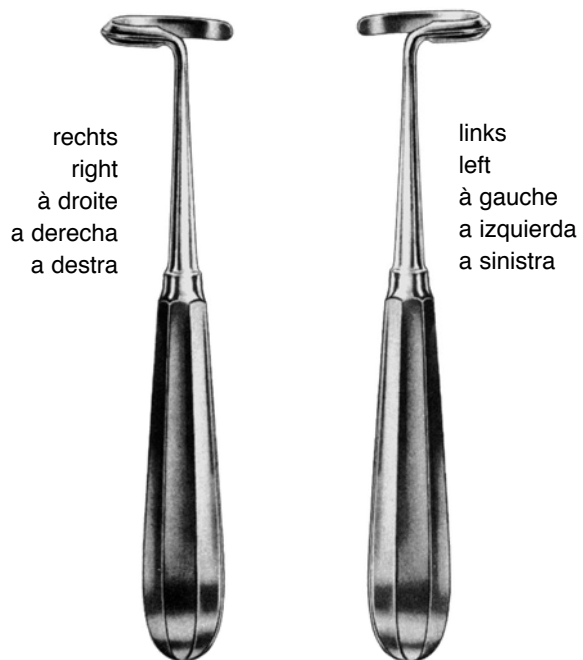

23.0580 17 cm **23.0581**
Kinder / Children / Enfants / Niños / Bambini



23.0582 17 cm **23.0583**
23.0584 24 cm **23.0585**

Erwachsene / Adults / Adultes / Adultos / Adulti



MATSON
23.0590

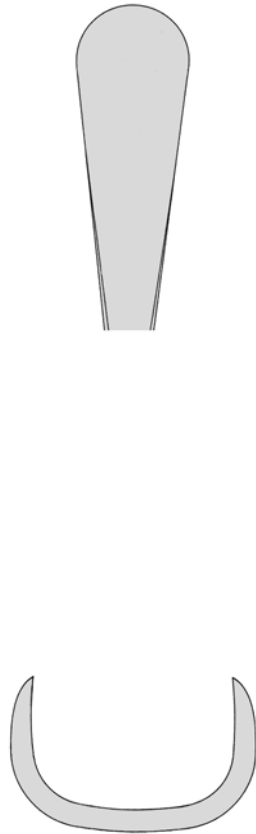

OVERHOLT
23.0592
28,5 cm #3



OVERHOLT
23.0593
29 cm #1



OVERHOLT
23.0594
28,5 cm #2



23.0601
 17,5 cm
 #1



23.0602
 21 cm
 #2



23.0603
 17,5 cm
 #3



23.0604
 21 cm
 #4



23.0605
 20,5 cm
 #5



23.0606
 20,5 cm
 #6



23.0607
 22,5 cm
 #7

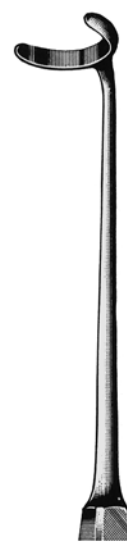

SEMB



WAGNER
 33 cm

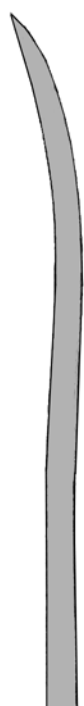

23.0608
 8 mm

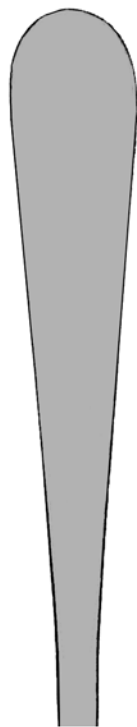
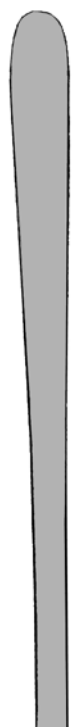

23.0609
 17 mm

Kunststoffgriff
 plastic handle
 manche en matière plastique
 mangos de madera artificial
 manico in plastica



RASPATORIUM
23.0610
 27,5 cm / 21 mm

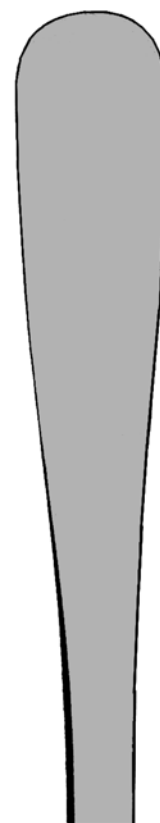
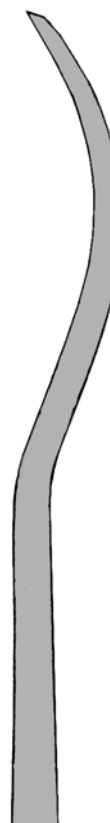

Kunststoffgriff
 plastic handle
 manche en matière plastique
 mangos de madera artificial
 manico in plastica



COBB
25 cm

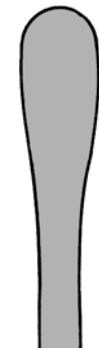
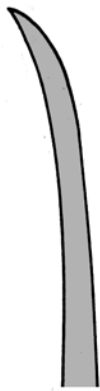

23.0611
10mm

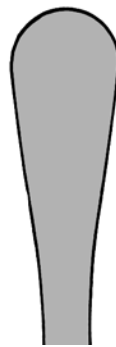

23.0612
13 mm

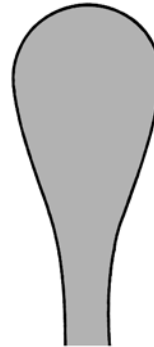

23.0613
19 mm

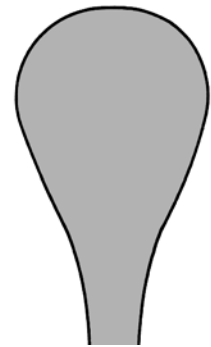

23.0614
25 mm

Kunststoffgriff
plastic handle
manche en matière plastique
mangos de madera artificial
manico in plastica



CUSHING
19 cm

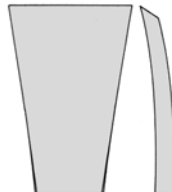

23.0620

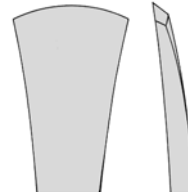

23.0621



MARTIN-CUSHING

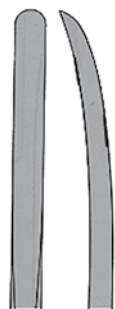

23.0624
 17,5cm/4mm



23.0625
 17,5cm/5mm



23.0626
 19,5cm/6mm



23.0627
 19,5cm/7mm



23.0628
 17cm/8mm



35 cm

Hohlheft
 hollow handle
 manche creux
 mango hueco
 manico cavo



23.0790
 13 mm



23.0792
 16 mm



23.0794
 19 mm



23.0796
 25 mm

Bariatrisch

bariatrische Chirurgie
 Bariatric Surgery
 Chirurgie bariatrique
 Cirugia bariiatrica
 Chirurgia bariiatrica

KNOCHENFEILEN, KNOCHENRASPELN
BONE FILES AND RASPS
LIMES A OS, RAPES
LIMAS PARA HUESOS, ESCOFINAS
LIME PER OSSA, RASPE



JOSEPH
16 cm



33.2200
fein / fine
fine / fina
fino



33.2201
grob / coarse
grosse / gruesa
grezzo



MALTZ
18 cm

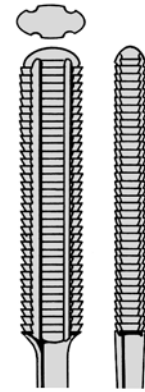

33.2210



MALTZ
19 cm

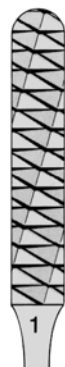

33.2211
12



33.2212
14

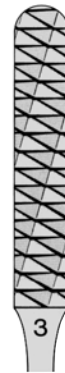

33.2213
16

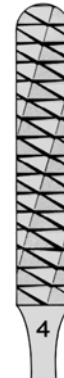

33.2214
20

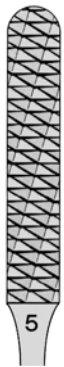

33.2215
24

Zähne / teeth / dents / dientes / denti

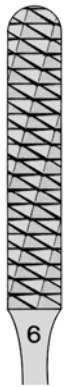

33.2216
30

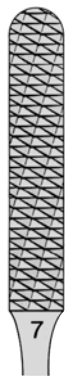

33.2217
36

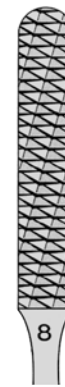

33.2218
44

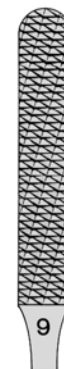

33.2219
52

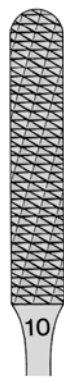

33.2220
62

Zähne / teeth / dents / dientes / denti

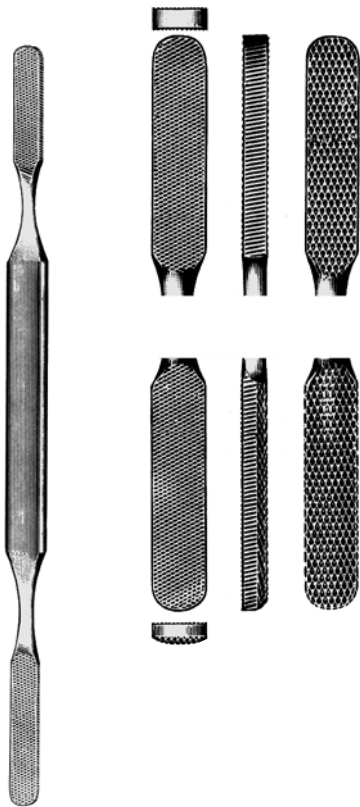

FOMON
33.2224
21 cm



FOMON
33.2225
21 cm
fein / fine
fine / fina
fino



FOMON
33.2226
21 cm
grob / coarse
grosse / gruesa
grezzo

KNOCHENFEILEN, KNOCHENRASPELN
BONE FILES AND RASPS
LIMES A OS, RAPES
LIMAS PARA HUESOS, ESCOFINAS
LIME PER OSSA, RASPE

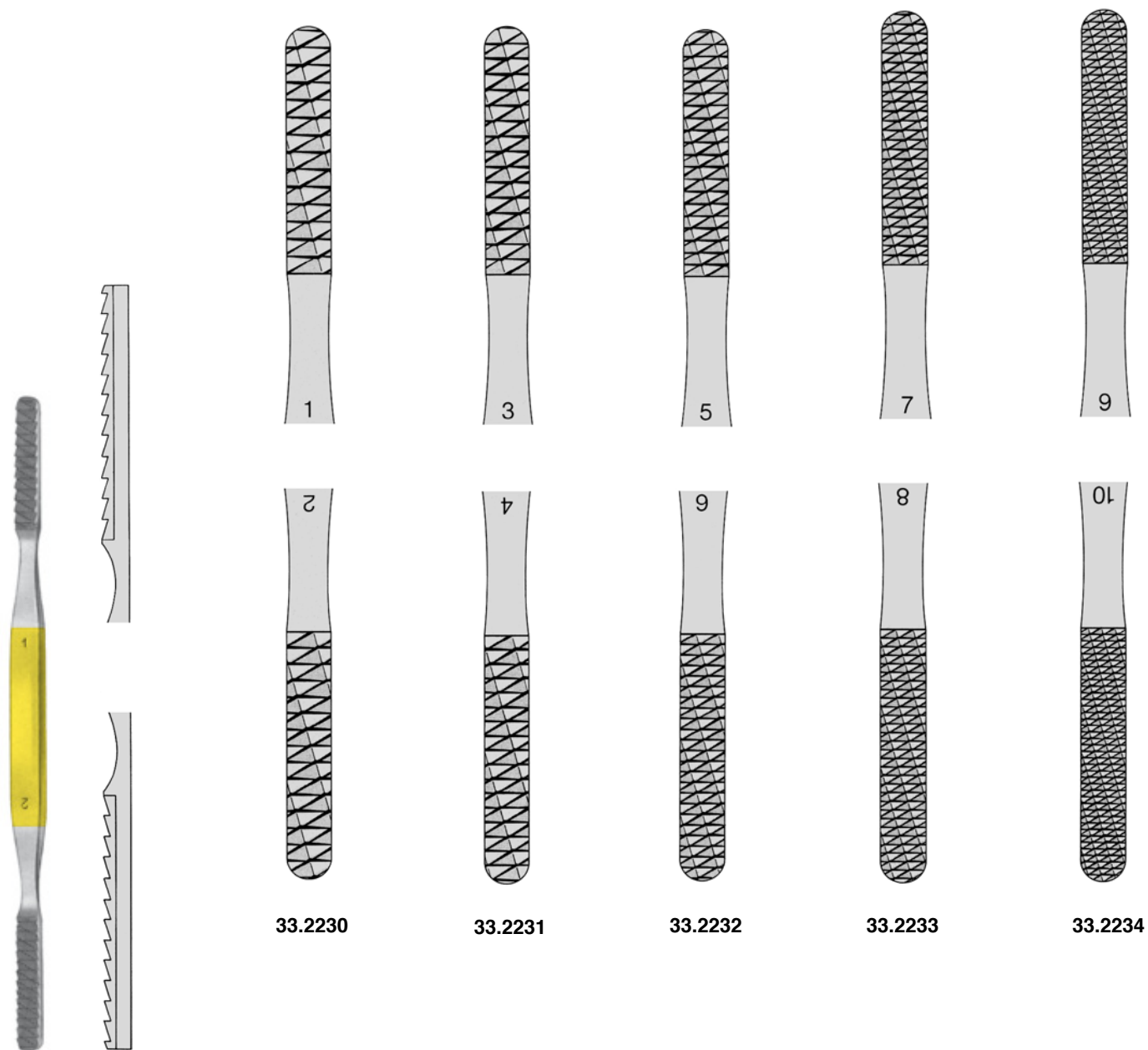

FOMON
20 cm



WIENER
18 cm



33.2250



33.2255



AUFRICHT
21 cm



33.2260

auf Stoß schneidend
 up-cutting
 tranchant à impact
 cortante a empuje
 tagliente a urto

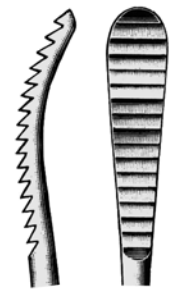

33.2265

auf Zug schneidend
 down-cutting
 tranchant à traction
 cortante a tracción
 tagliente a trazione



LEWIS
18 cm



33.2270
fein / fine
fine / fina
fino



33.2275
grob / coarse
grosse / gruesa
grezzo



COTTLE
33.2281
21 cm

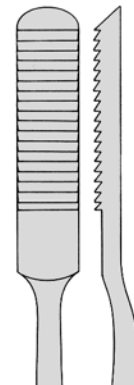

KNOCHENFEILEN, KNOCHENRASPELN
BONE FILES AND RASPS
LIMES A OS, RAPES
LIMAS PARA HUESOS, ESCOFINAS
LIME PER OSSA, RASPE



7,5 x 16 mm

5 x 10 mm

MILLER
33.2310
 18 cm

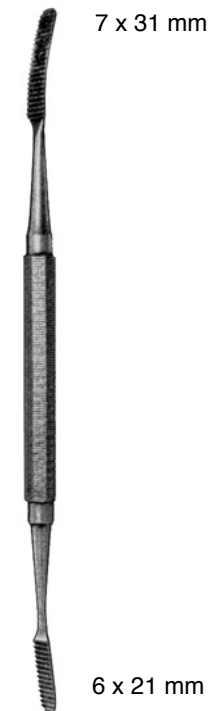

7 x 31 mm

6 x 21 mm

MILLER
33.2311
 18 cm



4 x 32 mm

4,5 x 10 mm

MILLER
33.2312
 18 cm



MILLER
33.2320
 18,5 cm
 "STRAIGHT-CUT"

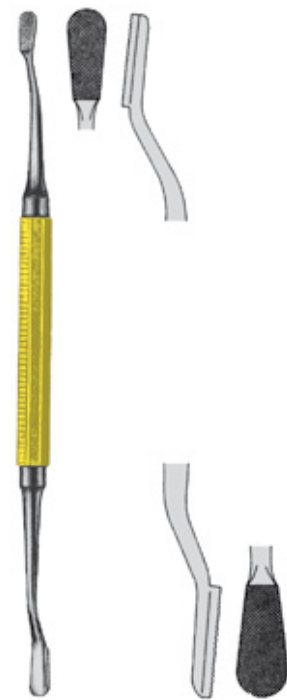

MILLER
33.2322
 18,5 cm
 "CROSS-CUT"

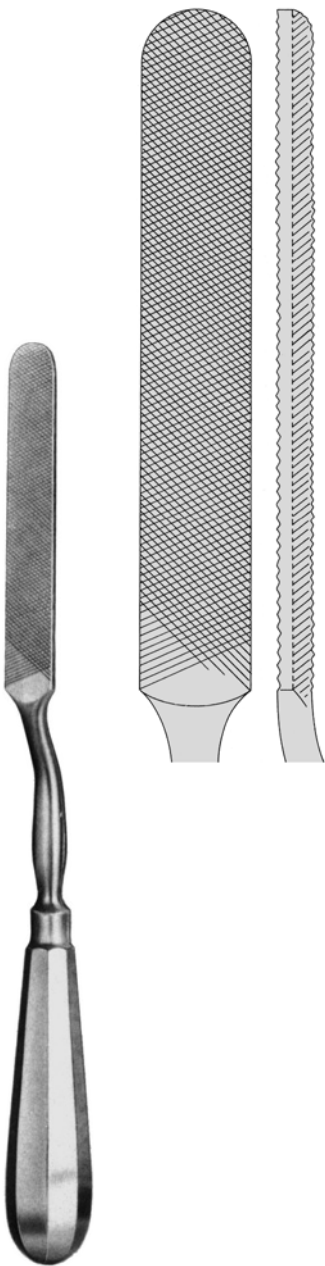

23.0800
24 cm

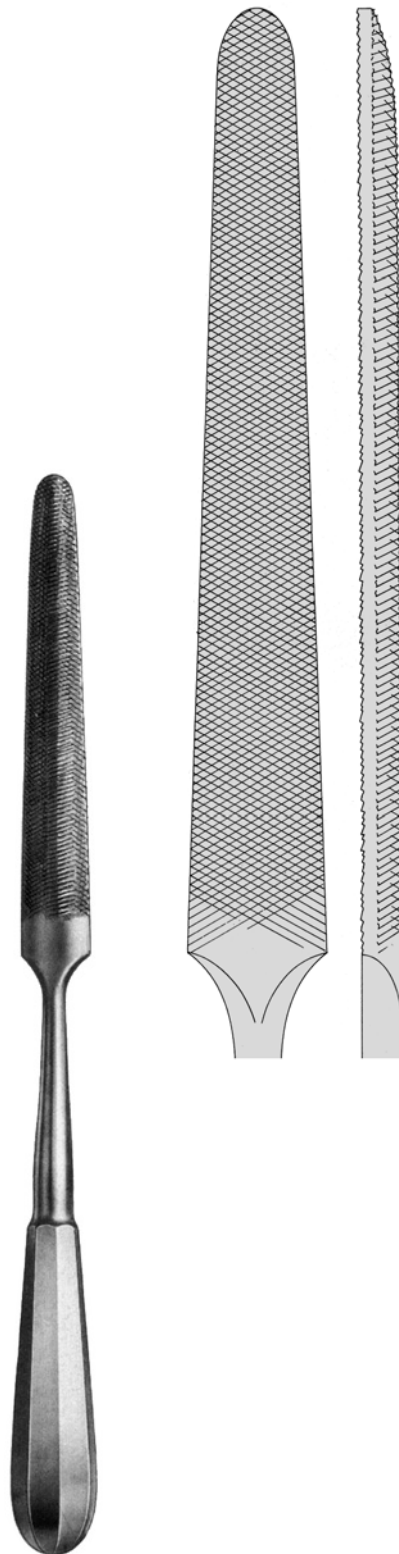

23.0810
28 cm

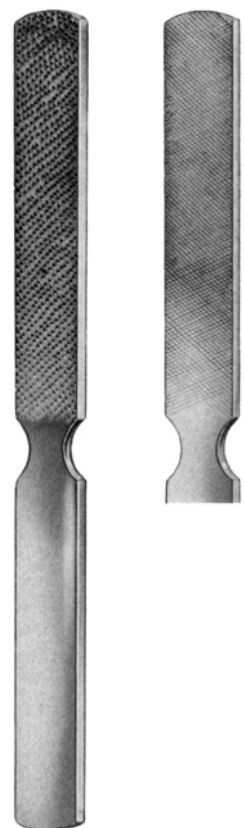

23.0820
22 cm / 20 mm

KNOCHENFEILEN, KNOCHENRASPELN
BONE FILES AND RASPS
LIMES A OS, RAPES
LIMAS PARA HUESOS, ESCOFINAS
LIME PER OSSA, RASPE



PUTTI
23.0830
30 cm



PUTTI
23.0832
28 cm

**KNOCHENSTOPFER, STÖSSEL
BONE TAMPERS, HEMOSTATS
POUSSIERS A OS, BURINS A HEMOSTASE
PUNZONES, CINCELES TAMPONADOR PARA HUESOS
RAMMENDATORE PER OSSA, PESTONI**



15,5 cm

23.0842
2 mm

23.0843
3 mm

23.0844
4 mm

23.0845
5 mm

23.0846
6 mm

23.0848
8 mm

23.0850
10 mm



PASSOW

23.0860 2,5 mm

23.0862 3,5 mm



20 cm

23.0863
3 mm

23.0866
12 mm

23.0864
5 mm

23.0867
14 mm

23.0865
8 mm

23.0868
16 mm



23.0990
15 cm

Reinigungsinstrument
Scaler
Instrument pour nettoyer
Instrumento para limpiar
Strumento per pulire

**SCHARFE LÖFFEL
SHARP CURETTES
CURETTES TRANCHANTES
CUCHARILLAS CORTANTES
CUCCHIAI TAGLIANTI**

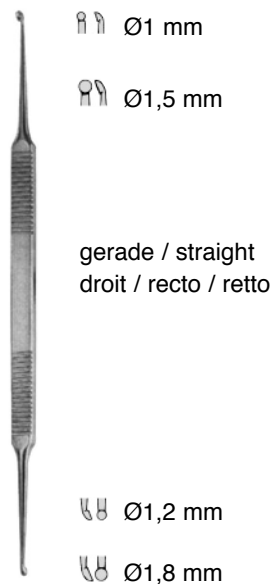

HOUSE

32.1150 Ø1,0 mm / 1,2 mm
32.1152 Ø1,5 mm / 1,8 mm
 16 cm

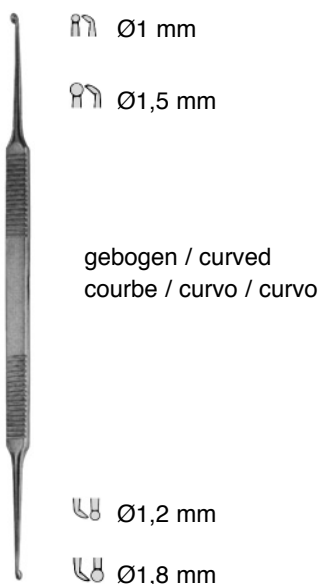

HOUSE

32.1151 Ø1,0 mm / 1,2 mm
32.1153 Ø1,5 mm / 1,8 mm
 16 cm

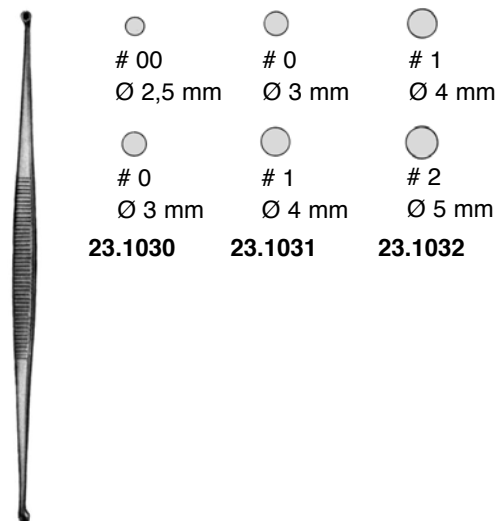

MARTINI

13,5 cm



JANSEN

23.1036 16 cm



JANSEN

23.1037 16 cm

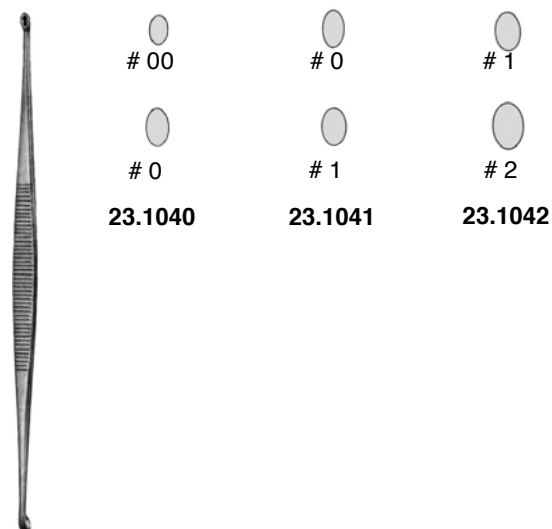

WILLIGER

13,5 cm



VOLKMANN
 17 cm

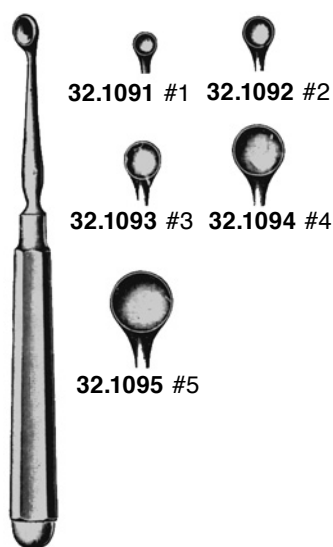
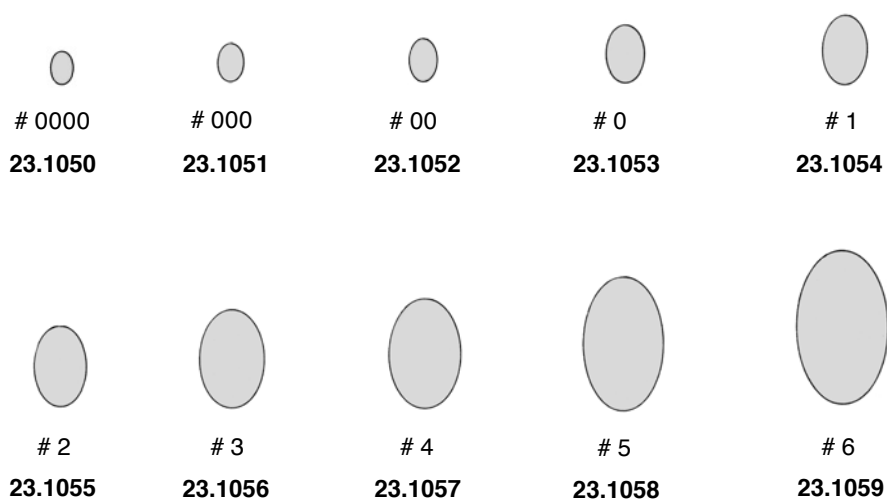

BUCK
 14,5 cm



BISHOP
 16 cm

SCHARFE LÖFFEL
SHARP CURETTES
CURETTES TRANCHANTES
CUCHARILLAS CORTANTES
CUCCHIAI TAGLIANTI



23.1020
00
Ø 2,5 mm

23.1021
0
Ø 3,2 mm

23.1022
1
Ø 4 mm

23.1023
2
Ø 5,7 mm

WILLIGER
17,5 cm

23.1025
00
Ø 3 mm

23.1026
0
Ø 4 mm

23.1027
1
Ø 5 mm

23.1028
2
Ø 6 mm



LEMPERT
21 cm

32.1100
00000
Ø 1,5 mm

32.1101
0000
Ø 2 mm

32.1102
000
Ø 2,2 mm

32.1103
00
Ø 2,5 mm

32.1104
0
Ø 2,7 mm

32.1105
1
Ø 3 mm

32.1106
2
Ø 3,3 mm



SPRATT
17 cm

23.1000
000

23.1002
0

23.1004
2

23.1006
4

23.1001
00

23.1003
1

23.1005
3

23.1007
5



VOLKMANN
23.1010 13 cm
23.1011 14 cm
23.1012 17 cm
23.1013 20 cm



VOLKMANN
23.1015 13 cm
23.1016 16 cm
23.1017 20 cm



BRUNS
 17 cm

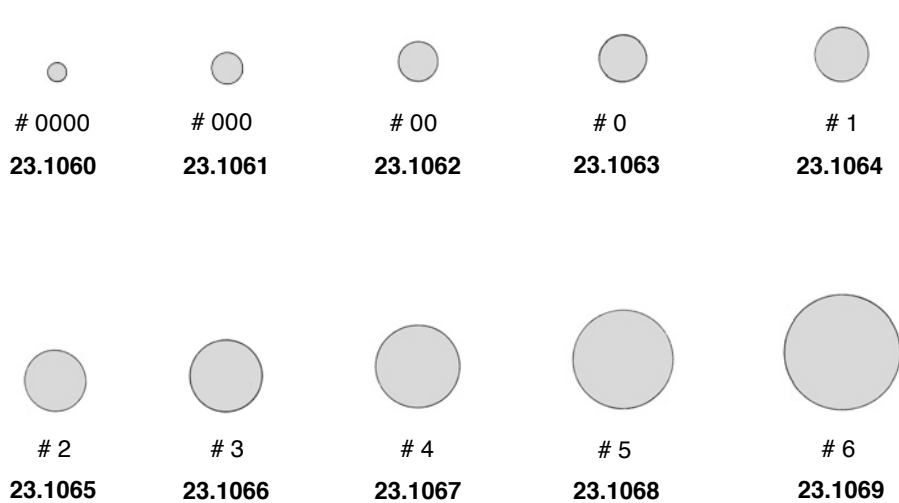

SCHEDE
 17 cm

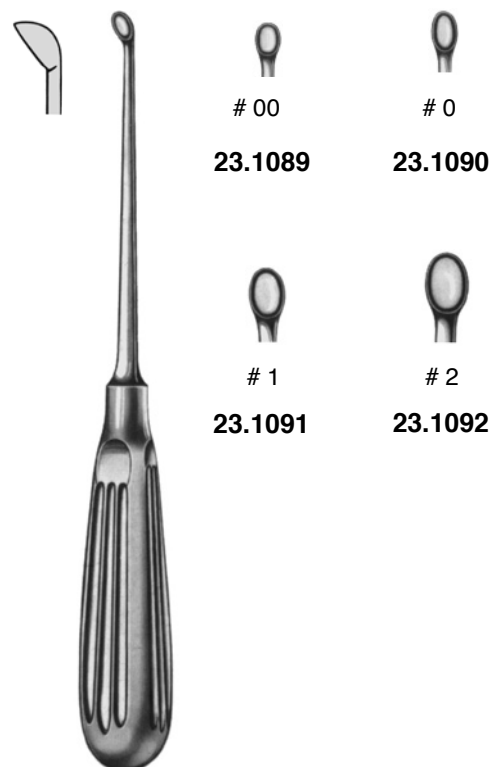
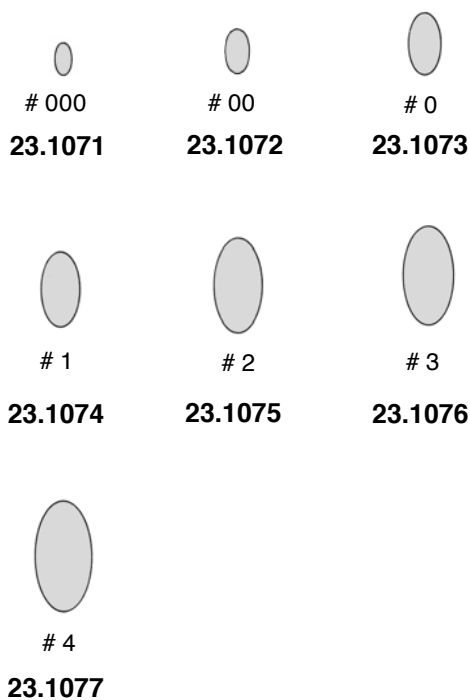

DAUBENSPECK
 20 cm

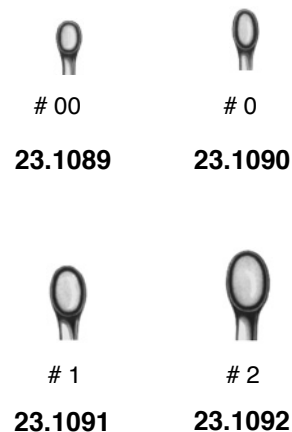

SCHARFE LÖFFEL
SHARP CURETTES
CURETTES TRANCHANTES
CUCHARILLAS CORTANTES
CUCCHIAI TAGLIENTI



VOLKMANN
22cm

23.1101
1, 3/5 mm

23.1102
2, 4/6 mm

23.1103
3, 5/7 mm

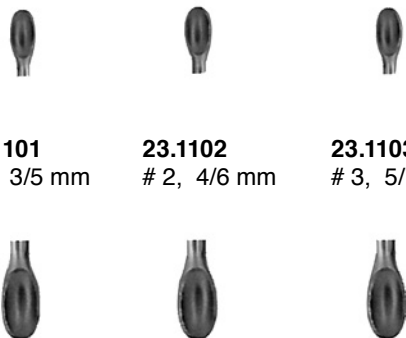

1
23.1094



2
23.1095



3
23.1096

biegsam
malleable
maléable
flexible



HALLE
21 cm

1
23.1104

2
23.1105

3
23.1106

4
23.1107

5
23.1108

6
23.1109



SIMON
24 cm



25 cm



23.1140
3,6 mm



23.1141
4,4 mm



23.1142
5,2 mm



23.1143
6,0 mm



25 cm



23.1144
3,6 mm



23.1145
4,4 mm



23.1146
5,2 mm



23.1147
6,0 mm

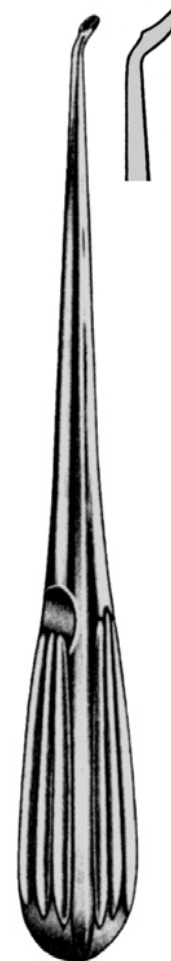

BUSHE
25 cm



23.1148
3 mm



23.1149
4 mm



23.1150
5 mm

**SCHARFE LÖFFEL
SHARP CURETTES
CURETTES TRANCHANTES
CUCHARILLAS CORTANTES
CUCCHIAI TAGLIANTI**



VOLKMANN

27 cm

mit Ferrozellgriff
with artificial wood-handles
avec manches en bois artificiel
con mangos de madera artificial
con manico in plastica



USA

16 cm

gerade / straight / droit / recta / retto

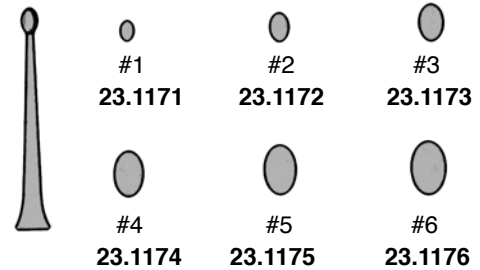

rechts gebogen / curved to right
courbe à droite / curvo derecho / curvo a destra

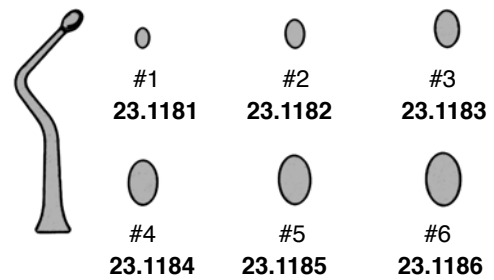

links gebogen / curved to left / courbe à gauche /
curvo izquierdo / curvo a sinistra

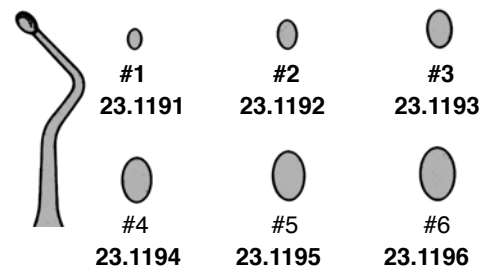



COBB
 28 cm

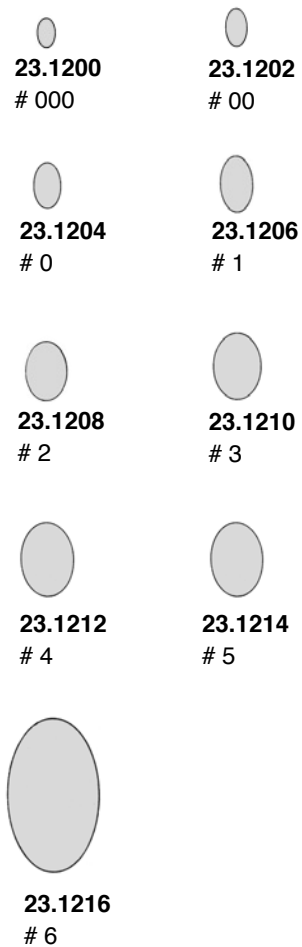





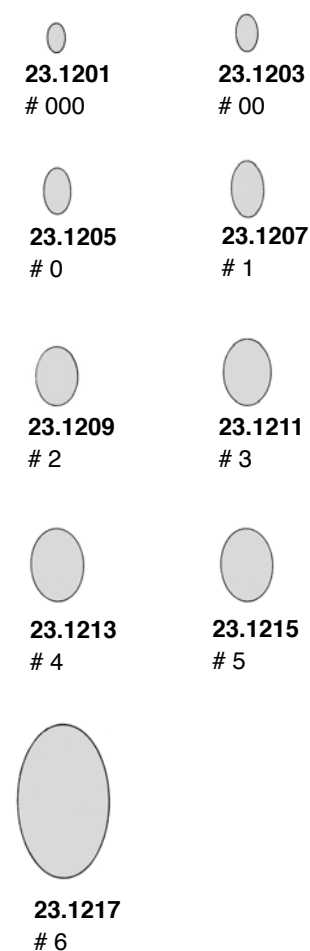











COBB
 28 cm

gebogen
 curved
 courbe
 curva
 curvo



SCHARFE LÖFFEL
SHARP CURETTES
CURETTES TRANCHANTES
CUCHARILLAS CORTANTES
CUCCHIAI TAGLIANTI

mit Hohlgriff
with hollow handle
avec manche creux
con mango hueco
con manico cavo

					
		# 0000			
					
		# 000			
	23 cm				
23.1220.23	# 0000			23.1221.23	# 0000
23.1222.23	# 000			23.1223.23	# 000
23.1224.23	# 00	# 00		23.1225.23	# 00
23.1226.23	# 0			23.1227.23	# 0
23.1228.23	# 1			23.1229.23	# 1
23.1230.23	# 2	# 0		23.1231.23	# 2
23.1232.23	# 3			23.1233.23	# 3
23.1234.23	# 4			23.1235.23	# 4
23.1236.23	# 5			23.1237.23	# 5
23.1238.23	# 6	# 1		23.1239.23	# 6
	28 cm				
23.1220.28	# 0000			23.1221.28	# 0000
23.1222.28	# 000			23.1223.28	# 000
23.1224.28	# 00	# 2		23.1225.28	# 00
23.1226.28	# 0			23.1227.28	# 0
23.1228.28	# 1			23.1229.28	# 1
23.1230.28	# 2			23.1231.28	# 2
23.1232.28	# 3	# 3		23.1233.28	# 3
23.1234.28	# 4			23.1235.28	# 4
23.1236.28	# 5			23.1237.28	# 5
23.1238.28	# 6	# 4		23.1239.28	# 6
	38 cm				
23.1220.38	# 0000			23.1221.38	# 0000
23.1222.38	# 000			23.1223.38	# 000
23.1224.38	# 00			23.1225.38	# 00
23.1226.38	# 0			23.1227.38	# 0
23.1228.38	# 1	# 5		23.1229.38	# 1
23.1230.38	# 2			23.1231.38	# 2
23.1232.38	# 3			23.1233.38	# 3
23.1234.38	# 4			23.1235.38	# 4
23.1236.38	# 5			23.1237.38	# 5
23.1238.38	# 6	# 6		23.1239.38	# 6

30°

SPINAL-LÖFFEL
SPINAL FUSION CURETTES
CURETTES TRANCHANTES POUR LA FUSION SPINALE
CURETAS CORTANTES PARA LA FUSION ESPINAL
CURETTE TAGLIANTI PER LA FUSIONE SPINALE



3



4



5



6

BRUNS

23 cm

23.1111 # 000
 23.1112 # 00
 23.1113 # 0
 23.1114 # 1
 23.1115 # 2
 23.1116 # 3
 23.1117 # 4
 23.1118 # 5
 23.1119 # 6

20 cm

23.1111.20 # 000
 23.1112.20 # 00
 23.1113.20 # 0
 23.1114.20 # 1
 23.1115.20 # 2
 23.1116.20 # 3
 23.1117.20 # 4
 23.1118.20 # 5
 23.1119.20 # 6

BRUNS

23 cm

23.1121 # 000
 23.1122 # 00
 23.1123 # 0
 23.1124 # 1
 23.1125 # 2
 23.1126 # 3
 23.1127 # 4
 23.1128 # 5
 23.1129 # 6

20 cm

23.1121.20 # 000
 23.1122.20 # 00
 23.1123.20 # 0
 23.1124.20 # 1
 23.1125.20 # 2
 23.1126.20 # 3
 23.1127.20 # 4
 23.1128.20 # 5
 23.1129.20 # 6

BRUNS

23 cm

23.1241 # 000
 23.1242 # 00
 23.1243 # 0
 23.1244 # 1
 23.1245 # 2
 23.1246 # 3
 23.1247 # 4
 23.1248 # 5
 23.1249 # 6

BRUNS

23 cm

23.1131 # 000
 23.1132 # 00
 23.1133 # 0
 23.1134 # 1
 23.1135 # 2
 23.1136 # 3
 23.1137 # 4
 23.1138 # 5
 23.1139 # 6

SPINAL-LÖFFEL
 SPINAL FUSION CURETTES
 CURETTES TRANCHANTES POUR LA FUSION SPINALE
 CURETAS CORTANTES PARA LA FUSION ESPINAL
 CURETTE TAGLIENTI PER LA FUSIONE SPINALE



HATFIELD
23 cm

- 23.7000 # 000
- 23.7002 # 00
- 23.7004 # 0
- 23.7006 # 1
- 23.7008 # 2
- 23.7010 # 3
- 23.7012 # 4
- 23.7014 # 5
- 23.7016 # 6



HATFIELD
28 cm

- 23.7020 # 000
- 23.7022 # 00
- 23.7024 # 0
- 23.7026 # 1
- 23.7028 # 2
- 23.7030 # 3
- 23.7032 # 4
- 23.7034 # 5
- 23.7036 # 6



HATFIELD
28 cm

- 23.7021 # 000
- 23.7023 # 00
- 23.7025 # 0
- 23.7027 # 1
- 23.7029 # 2
- 23.7031 # 3
- 23.7033 # 4
- 23.7035 # 5
- 23.7037 # 6



000
3 mm



00
3,5 mm



0
4,5 mm



1
5 mm



2
6 mm



3
7 mm



4
8,5 mm



5
9,5 mm



6
10,5 mm



23.1280
 22 mm Ø
 200g
 bleigefüllt
 lead filled
 alourdi de plomb
 relleno de plomo
 pieno di piombo

23.1281
 22 mm Ø
 Stahl, massiv
 steel, solid
 acier, massif
 acero, macizo
 acciaio massiccio

PARTSCH
 18 cm



23.1290
 26 mm Ø
 300g
 bleigefüllt
 lead filled
 alourdi de plomb
 relleno de plomo
 pieno di piombo

WILLIGER
 24 cm

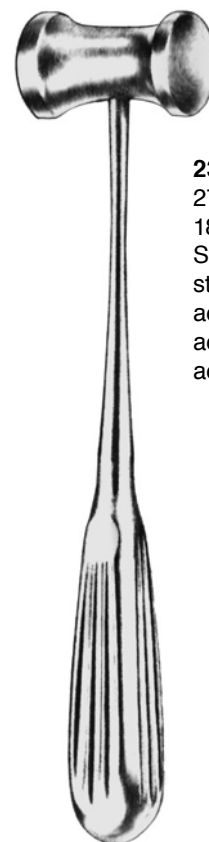

23.1300
 27 mm Ø
 180g
 Stahl, massiv
 steel, solid
 acier, massif
 acero, macizo
 acciaio massiccio

HAJEK
 21 cm



23.1302
 20 mm Ø
 140g
 bleigefüllt
 lead filled
 alourdi de plomb
 relleno de plomo
 pieno di piombo

23.1304
 20 mm Ø
 Stahl, massiv
 steel, solid
 acier, massif
 acero, macizo
 acciaio massiccio

THIESS
 16,5 cm

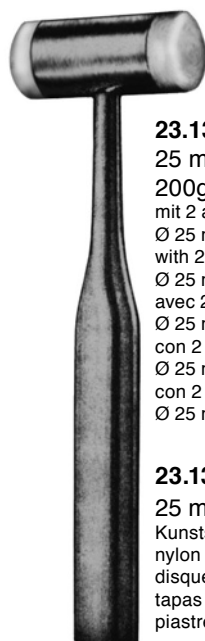

23.1305
 25 mm Ø
 200g
 mit 2 auswechselbaren Nylonbacken
 Ø 25 mm, 23.1306
 with 2 interchangeable nylon disks
 Ø 25 mm, 23.1306
 avec 2 disques en nylon interchangeables
 Ø 25 mm, 23.1306
 con 2 tapas de nilón intercambiables
 Ø 25 mm, 23.1306
 con 2 piastre di nylon intercambiabili
 Ø 25 mm, 23.1306

23.1306
 25 mm Ø
 Kunststoffbacken allein, paarweise
 nylon disks only, pair
 disques en nylon de recharge, paire
 tapas de nilon sueltas, par
 piastre di nylon, paio

18 cm

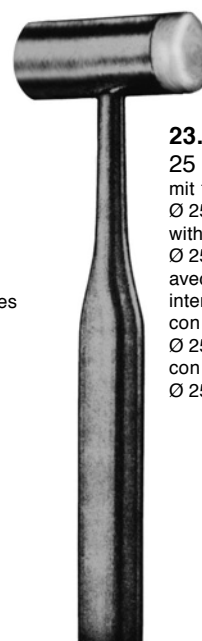

23.1307
 25 mm Ø
 mit 1 auswechselbaren Kunststoffbacke
 Ø 25 mm, 23.1308
 with 1 interchangeable plastic disk
 Ø 25mm. 23.1308
 avec 1 disque en matière plastique
 interchangeable Ø 25 mm, 23.1308
 con 1 tapa de plástico intercambiable
 Ø 25 mm, 23.1308
 con 1 piastra di plastica intercambiabile
 Ø 25 mm, 23.1308

18 cm

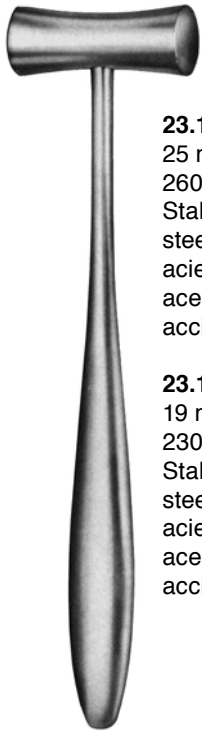

23.1310
 25 mm Ø
 260g
 Stahl, massiv
 steel, solid
 acier, massif
 acero, macizo
 acciaio massiccio

23.1311
 19 mm Ø
 230g
 Stahl, massiv
 steel, solid
 acier, massif
 acero, macizo
 acciaio massiccio

LUCAE
 19 cm

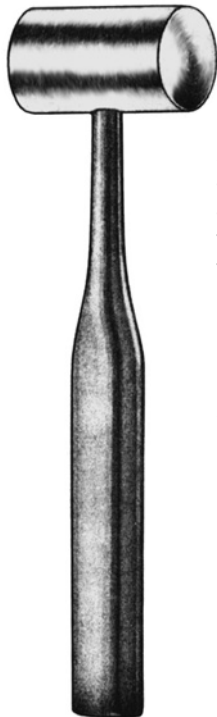

23.1315
 30 mm Ø
 300g
 flach / convex
 flat / convex
 plat / convexe
 piano / convesso

Stahl, massiv
 steel, solid
 acier, massif
 acero, macizo
 acciaio massiccio

COTTLE
 19 cm

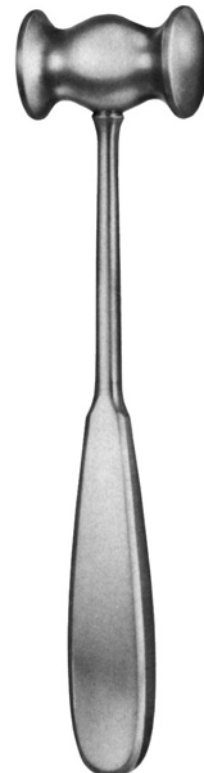

23.1316
 30 mm Ø
 200g
 Stahl, massiv
 steel, solid
 acier, massif
 acero, macizo
 acciaio massiccio

COLLIN
 20 cm



23.1320
 30 mm Ø
 400g
 bleigefüllt
 lead filled
 alourdi de plomb
 relleno de plomo
 pieno di piombo

GERZOG
 18 cm

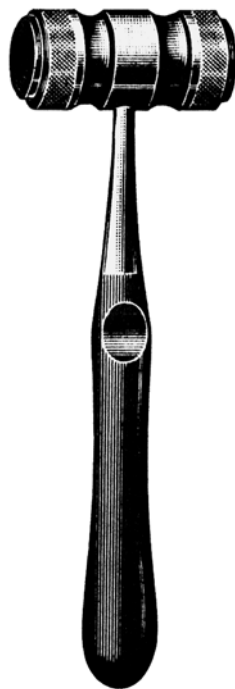

23.1330
 26 mm Ø
 320g
 mit 2 auswechselbaren Nylonbacken
 Ø 26mm, 23.1339
 with 2 interchangeable nylon disks
 Ø 26mm, 23.1339
 avec 2 disques en nylon interchangeables
 Ø 26 mm, 23.1339
 con 2 tapas de nilón intercambiables
 Ø 26 mm, 23.1339
 con 2 piastre di nylon intercambiabili
 Ø 26 mm, 23.1339

23.1332
 mit 2 auswechselbaren Ferrozellbacken
 Ø 26 mm, 23.1338
 with 2 interchangeable phenolic discs
 Ø 26 mm, 23.1338
 avec 2 disques en nylon interchangeables
 Ø 26 mm, 23.1338
 con 2 tapas de nilón intercambiables
 Ø 26 mm, 23.1338
 con 2 piastre di nylon intercambiabili
 Ø 26 mm, 23.1338

23.1339
 Kunststoffbacken allein, paarweise
 plastic disks only, pair
 disques de rechange, plastique
 tapas de plastica suelto par
 piastre di ricambio, paio

MEAD
 17 cm

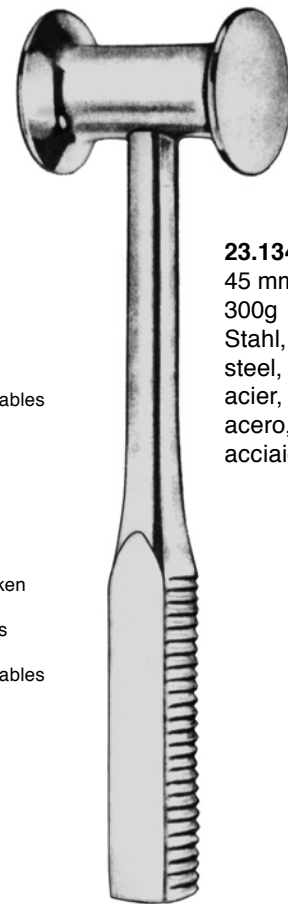

23.1340
 45 mm Ø
 300g
 Stahl, massiv
 steel, solid
 acier, massif
 acero, macizo
 acciaio massiccio

BERGMANN
 24 cm

Stahl, massiv
steel, solid
acier, massif
acero, macizo
acciaio massiccio



BERGMANN

23.1342

24 cm

30 mm Ø

300g

Stahl, massiv
steel, solid
acier, massif
acero, macizo
acciaio massiccio

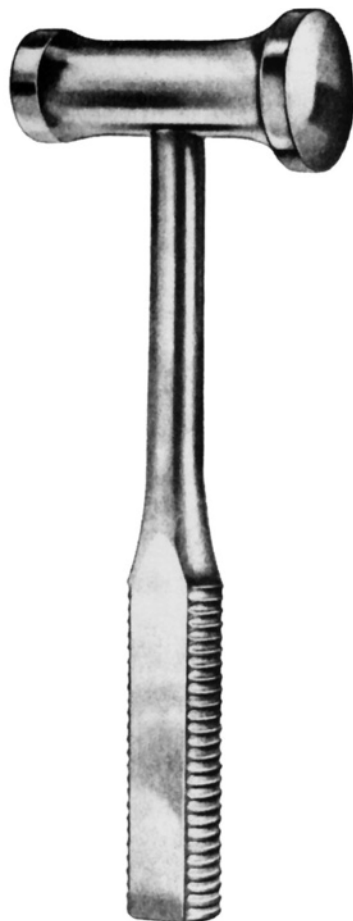

23.1346

24 cm

28 / 42 mm Ø

400g

Stahl, massiv
steel, solid
acier, massif
acero, macizo
acciaio massiccio

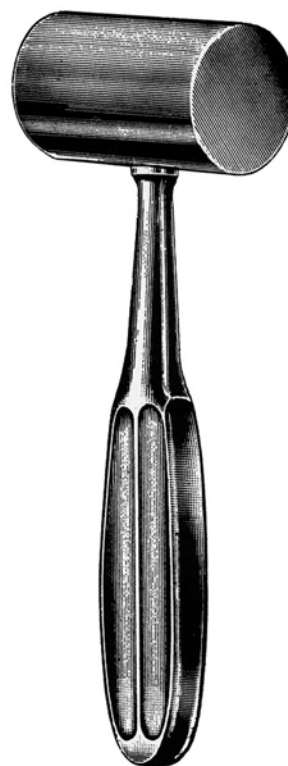

KIRK

23.1350

20 cm

40 mm Ø

680g

Kunststoff
plastic material
matiere plastique
material plastica
legno artificiale



23.1360

26 cm

42 mm Ø

250g

23.1362

26 cm

50 mm Ø

350g

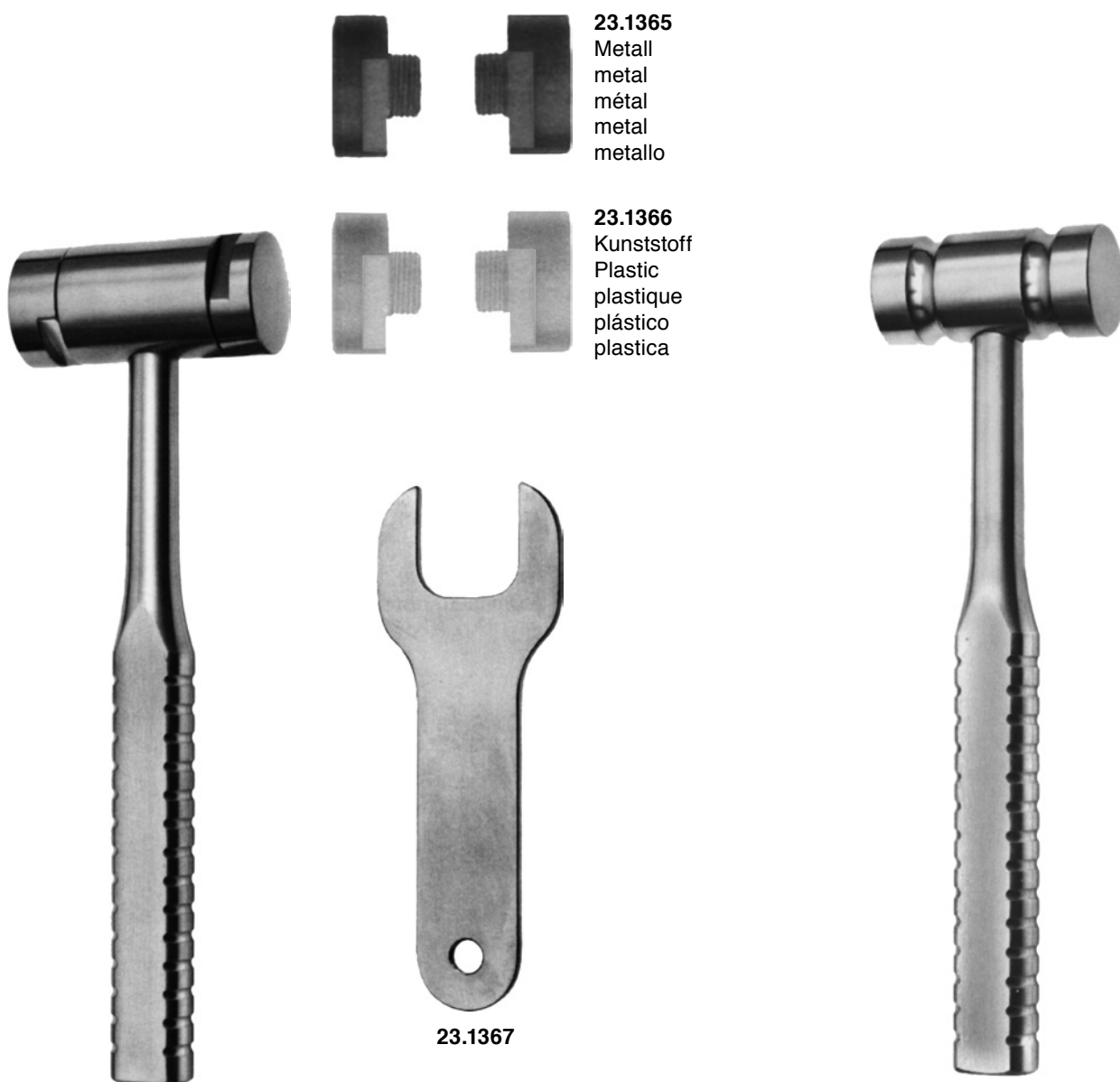

23.1365
Metall
metal
métal
metal
metallo

23.1366
Kunststoff
Plastic
plastique
plástico
plastica

23.1367

WAGNER

23.1364

24 cm, Ø 35 mm,
250g/440g

mit 1 Paar Metallbacken 23.1365, 1 Paar Kunststoffbacken 23.1366,
und 1 Schlüssel 23.1367

with 1 pair of metal disks 23.1365, 1 pair of plastic disks 23.1366,
and 1 wrench 23.1367

avec 1 paire de disques métalliques 23.1365, 1 paire de disques
plastiques 23.1366 et 1 clef 23.1367

con 1 par de tapas de metal 23.1365, 1 par de tapase de
plástico y 1 llave 23.1367

con 1 paio di piastre di metallo 23.1365, 1 paio di piastre di plastica
e 1 chiave 23.1367

23.1368

24 cm Ø 35mm
540g/720g

23.1369

24cm Ø 40mm
740g/920g

Stahl, massiv
steel, solid
acier, massif
acero, macizo
acciaio massiccio

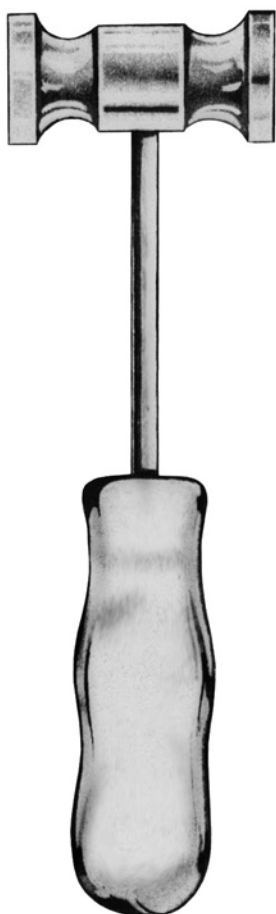

23.1371
24 cm
500g

23.1372
24 cm
800g



23.1374
26cm Ø35mm
450g/760g

23.1375
26cm Ø45mm
900g/1100g



23.1376
26 cm Ø32 mm
500g/700g



23.1377
24cm Ø35mm
380g/560g

23.1378
24cm Ø40mm
560g/740g

23.1379
24cm Ø45mm
800g/980g

Stahl, massiv
steel, solid
acier, massif
acero, macizo
acciaio massiccio

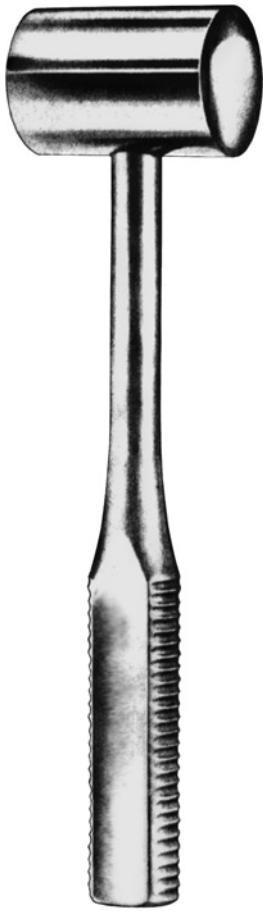

OMBREDANNE

23.1380
24 cm
40 mm Ø
550g

Kupferfüllung
copper filled
alourdi de cuivre
relleno de cobre
testa di rame

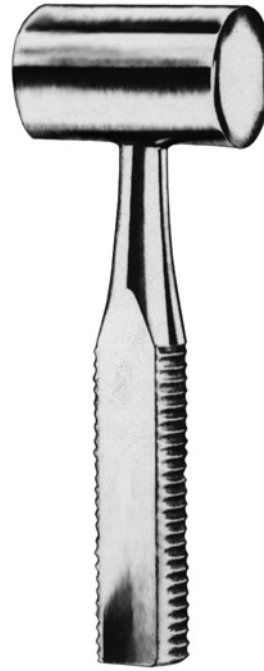

HEATH

23.1385
18 cm
40 mm Ø
700g

23.1386
18 cm
45 mm Ø
700g

mit auswechselbaren Kunststoffbacken
with interchangeable plastic discs
avec disques en matière plastique
interchangeables
con tapas plasticas intercambiables
con piastre di plastica

Stahl massiv / steel solid / acier, massif / acero, macizo / acciaio massiccio



23.1390
24 cm
27 mm Ø
300g



23.1391
24 cm
35 mm Ø
500g



23.1392
24 cm
40 mm Ø
700g



23.1398
24 cm
30 mm Ø
250g

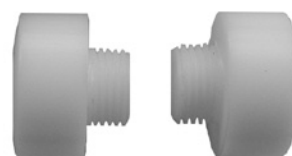

23.1399
Paar Ersatzbacken f. 23.1398
Spare disks pair for 23.1398
Disques de rechange pour 23.1398
Tapas/recambio para 23.1398
1 paio di piastre di plastica per 23.1398

MEISSEL, OSTEOTOME, HOHLMEISSEL
 CHISELS, OSTEOTOMES, GOUGES
 CISEAUX-BURINS, CINCELLES, GOUGES
 CINCELLES, GUBIAS, OSTEOTOMOS
 SCALPELLI, OSTEOTOMI, SGORBIE

Septummeißel / Septum Chisels / Ciseaux-burins pour la cloison nasale / Cinceles para tabique nasal / Scalpelli per il setto nasale

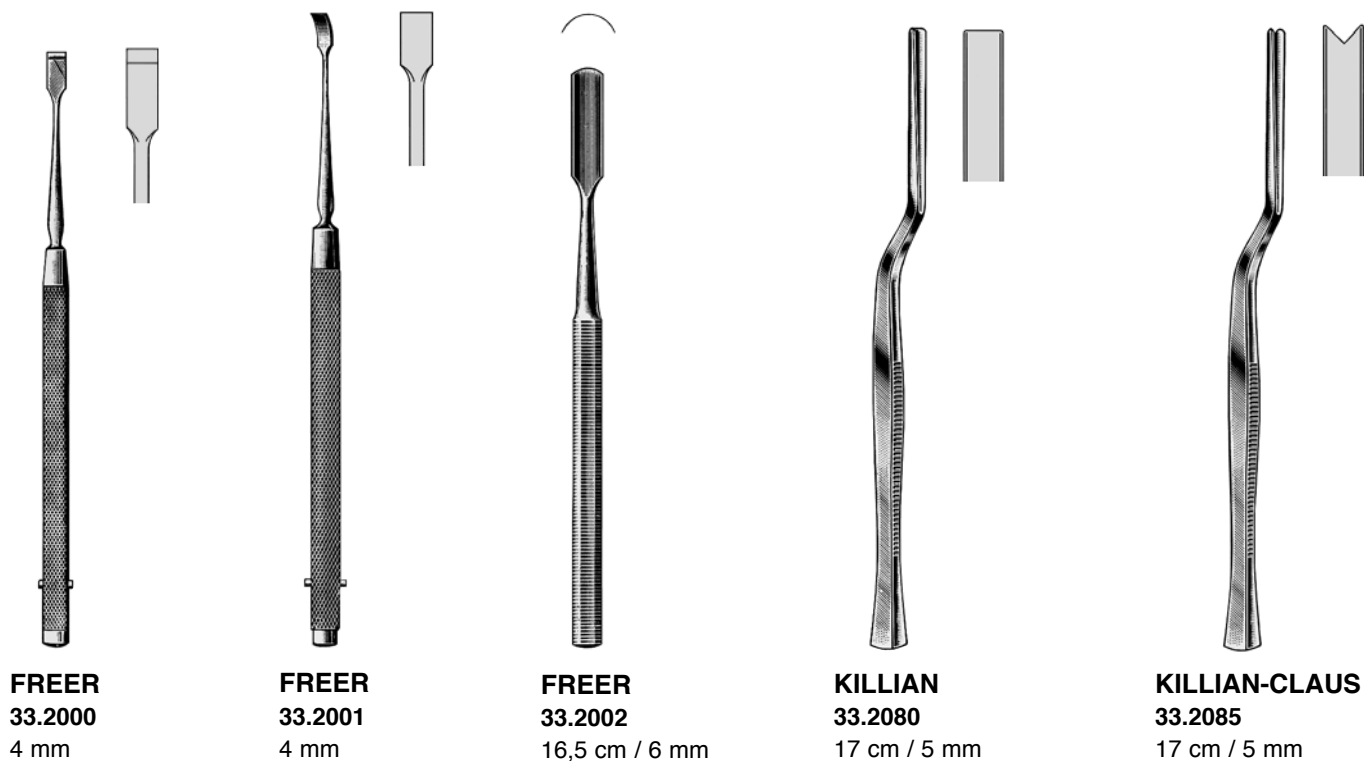

Osteotome / Osteotomes / Ostéotomes / Osteótomos / Osteotomi

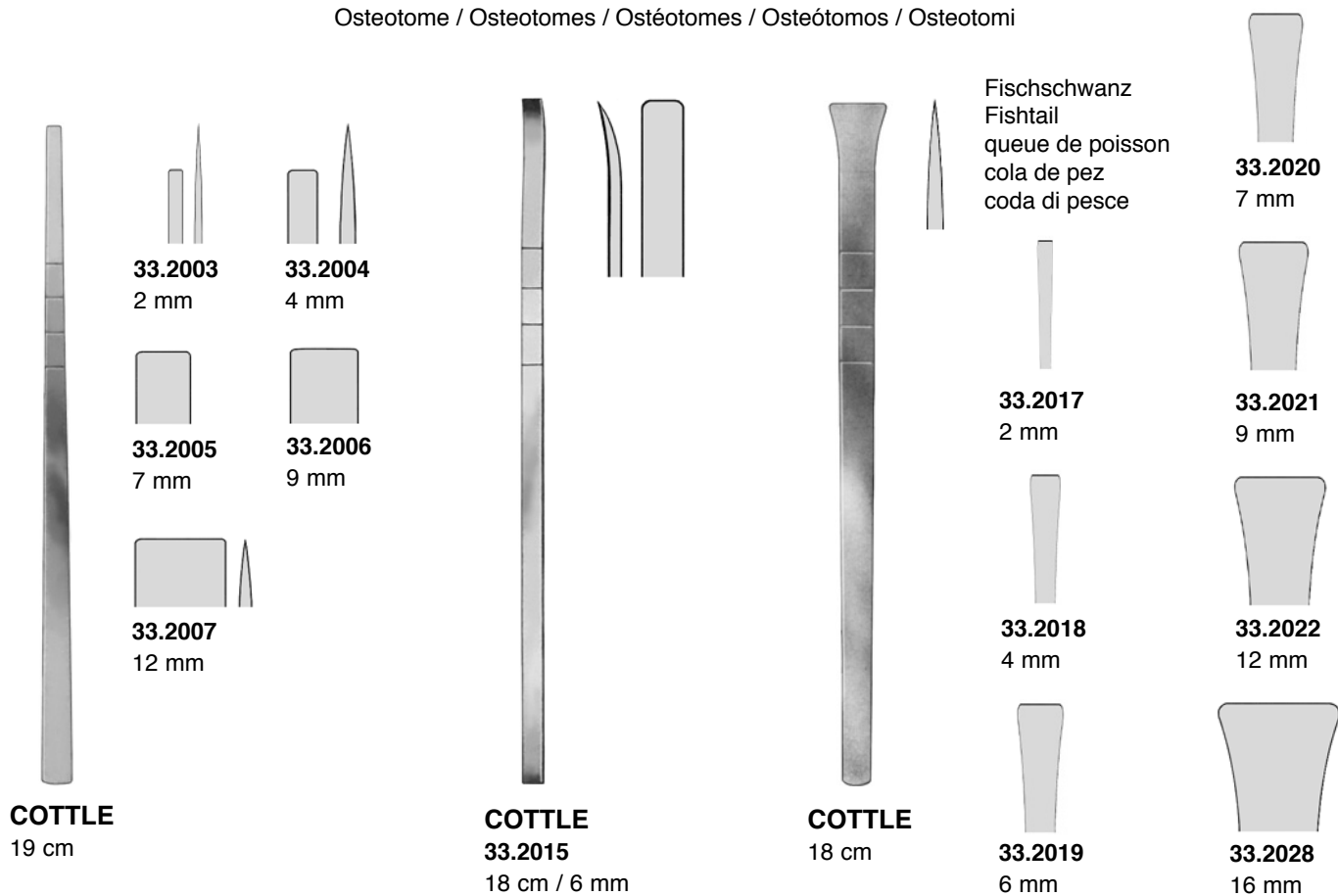

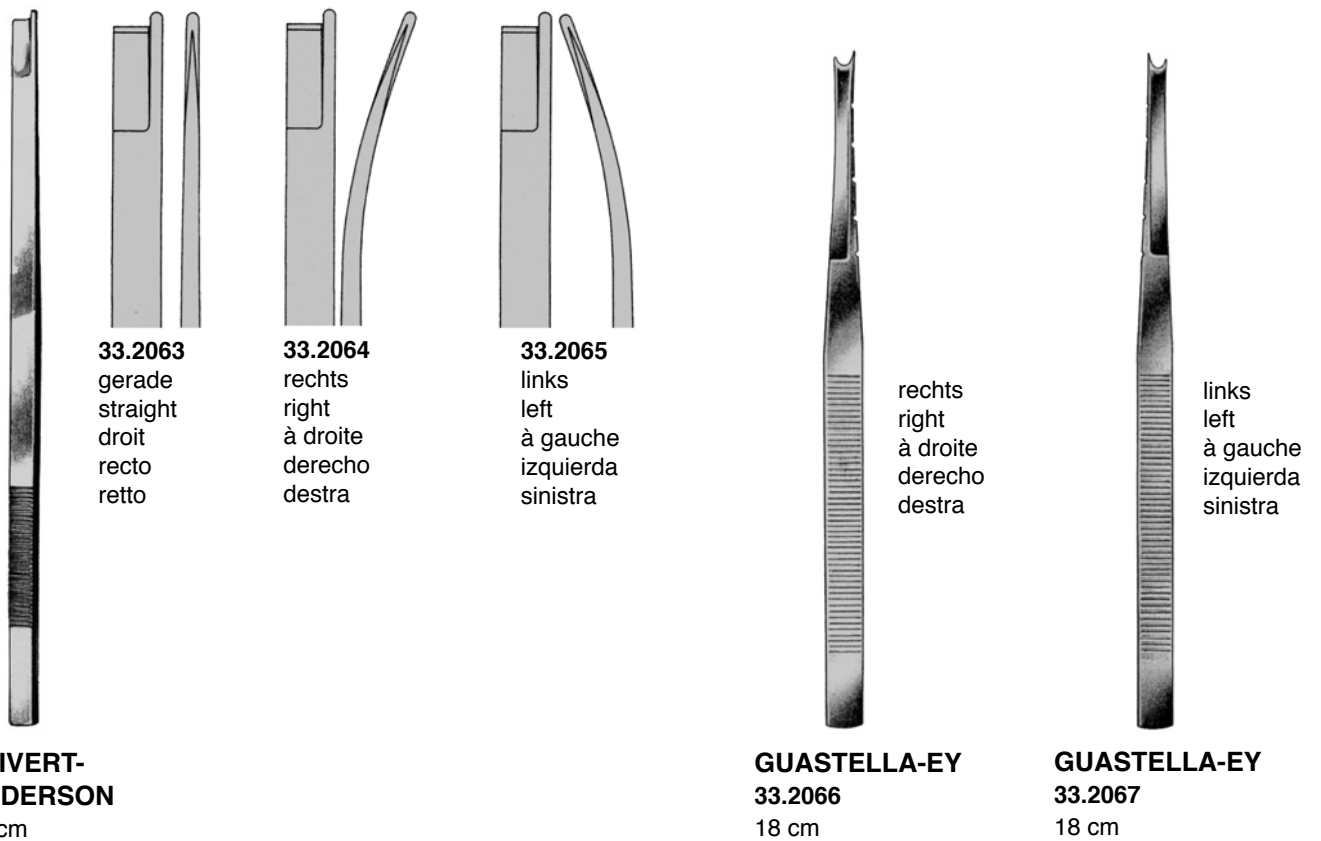
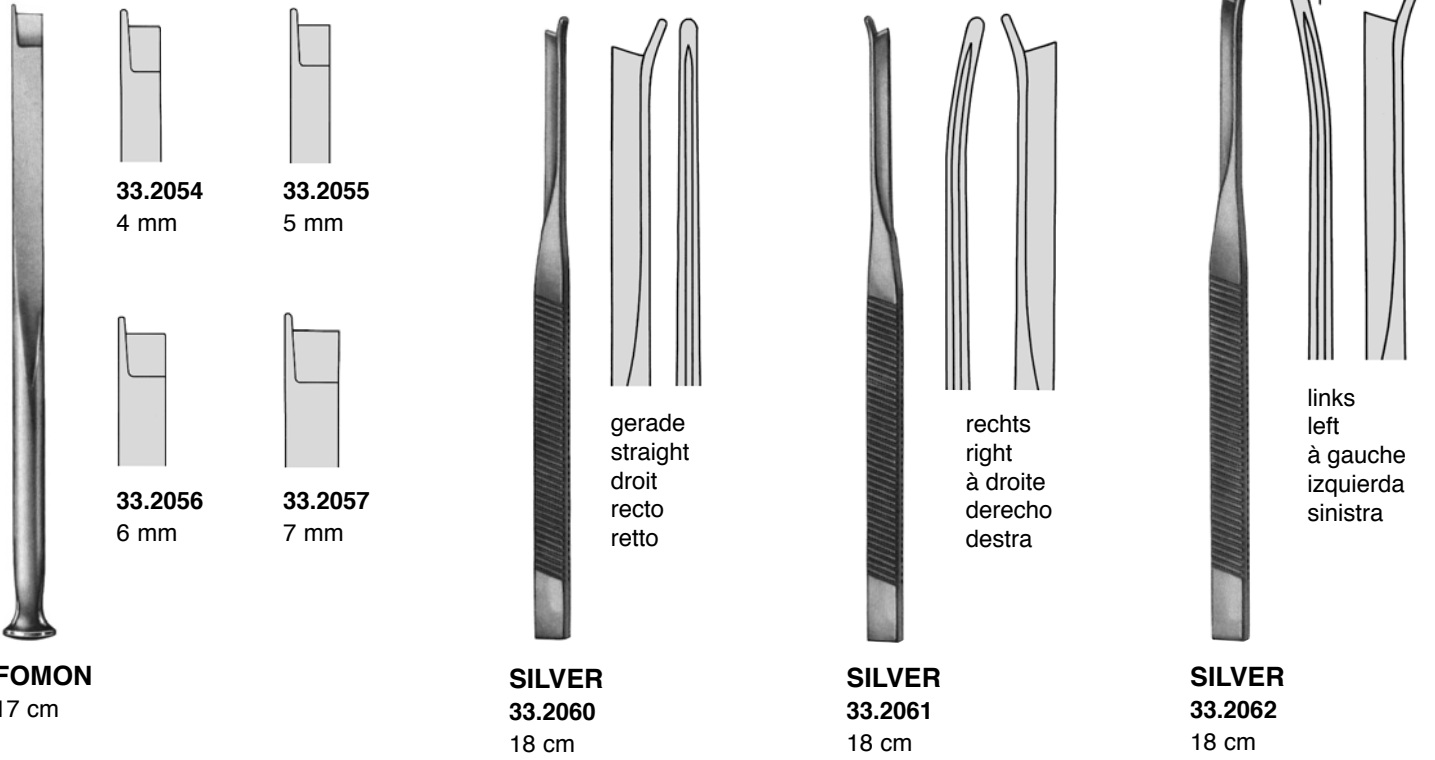

MEISSEL, OSTEOTOME, HOHLMEISSEL
 CHISELS, OSTEOTOMES, GOUGES
 CISEAUX-BURINS, CINCELLES, GOUGES
 CINCELLES, GUBIAS, OSTEOTOMOS
 SCALPELLI, OSTEOTOMI, SGORBIE

Meissel / Chisels / Ciseaux-burins / Cinceles / Scalpelli

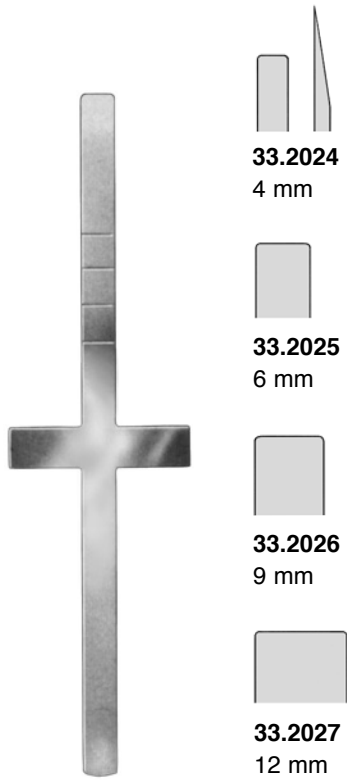

COTTLE
18 cm

33.2024
4 mm

33.2025
6 mm

33.2026
9 mm

33.2027
12 mm



LUCAS
33.2070
16 cm / 4 mm
33.2072
16 cm / 6 mm



LUCAS
33.2076
16 cm / 3 mm
33.2078
16 cm / 5 mm

Antrum-Meissel
 Antrum Trocar-Chisel
 Giuzge antral
 Gubia antral
 Sgorbia per cavita mascellare

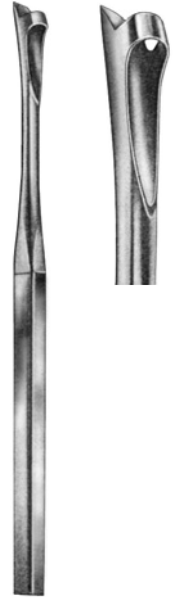

FAULKNER
33.2088
15 cm

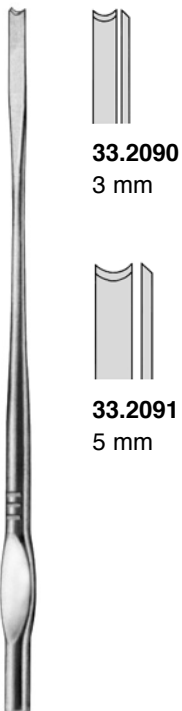

WALTER
19 cm

33.2090
3 mm

33.2091
5 mm

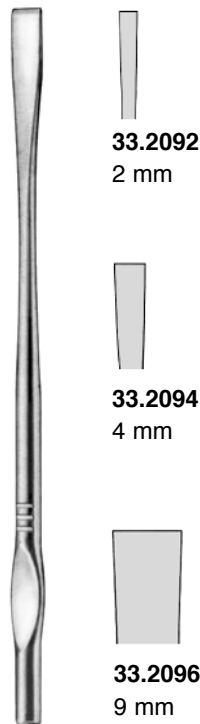

WALTER
19 cm

33.2092
2 mm

33.2094
4 mm

33.2096
9 mm

33.2093
3 mm

33.2095
7 mm

33.2097
12 mm

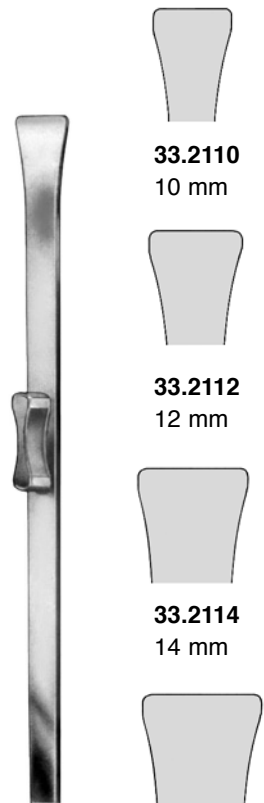

RUBIN
18 cm

33.2110
10 mm

33.2112
12 mm

33.2114
14 mm

33.2116
16 mm



CINELLI
16 cm

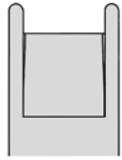

33.2120
10 mm

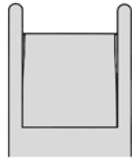

33.2122
12 mm

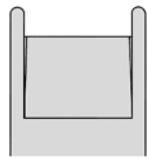

33.2124
14 mm

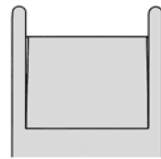

33.2126
16 mm

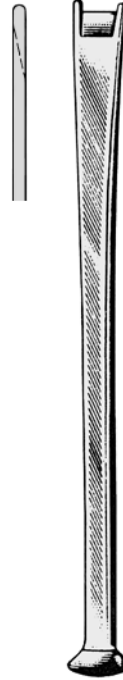

MOBERG
18 cm

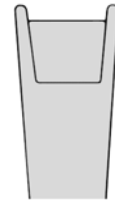

33.2130
10 mm

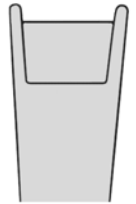

33.2132
12 mm

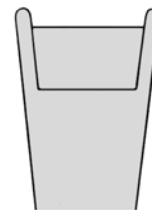

33.2134
14 mm

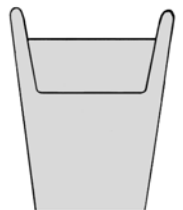

33.2136
16 mm



MCINDOE



33.2140
16 cm / 8 mm



33.2141
16 cm / 10 mm



33.2142
16 cm / 12 mm

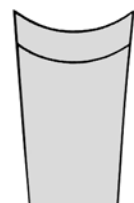

33.2143
17 cm / 15 mm

MEISSEL, OSTEOTOME, HOHLMEISSEL
CHISELS, OSTEOTOMES, GOUGES
CISEAUX-BURINS, CINCELLES, GOUGES
CINCELLES, GUBIAS, OSTEOTOMOS
SCALPELLI, OSTEOTOMI, SGORBIE



SHEEHAN
15 cm



33.2150
2 mm



33.2151
4 mm



33.2152
6 mm



33.2153
7 mm



33.2154
8 mm



33.2155
10 mm



33.2156
12 mm



33.2157
15 mm

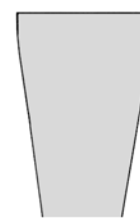

33.2158
18 mm



STEINHÄUSER
19 cm



34.4715
7 mm



34.4716
11 mm

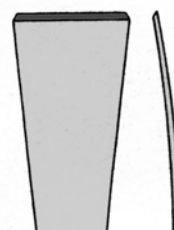

34.4717
15 mm



34.4702
2,5 mm

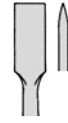

34.4704
4,0 mm

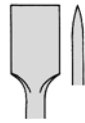

34.4706
6,0 mm

OSTEOTOM
15 cm



34.4707
7 mm

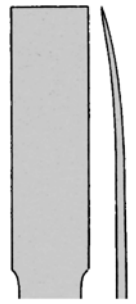

34.4710
10 mm

STEINHÄUSER
17 cm

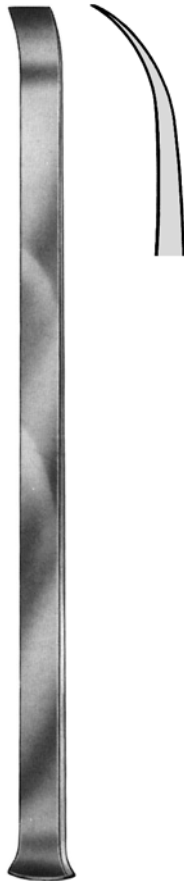

OBWEGESER
34.4750 23,5 cm



34.4760



34.4761

TESSIER
20 cm / 10 mm

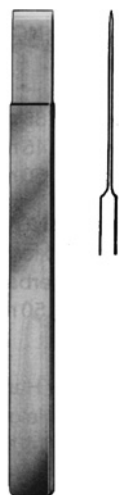

- 23.1870** 13 cm, 2 mm
- 23.1871** 13 cm, 4 mm
- 23.1872** 13 cm, 6 mm
- 23.1873** 13 cm, 8 mm
- 23.1874** 13 cm, 10 mm
- 23.1875** 13 cm, 12 mm
- 23.1876** 13 cm, 15 mm

HARDT-DELIMA



- 23.1880** 17 cm, 2 mm
- 23.1881** 17 cm, 4 mm
- 23.1882** 17 cm, 6 mm
- 23.1883** 17 cm, 8 mm
- 23.1884** 17 cm, 10 mm
- 23.1885** 17 cm, 12 mm
- 23.1886** 17 cm, 15 mm

HARDT-DELIMA



OBWEGESER
34.4770
21 cm / 7 mm



OBWEGESER
34.4772
21 cm / 10 mm



- 23.1410** 13,5 cm / 2 mm
- 23.1411** 13,5 cm / 3 mm
- 23.1412** 13,5 cm / 4 mm
- 23.1413** 13,5 cm / 5 mm
- 23.1414** 13,5 cm / 6 mm
- 23.1415** 13,5 cm / 7 mm
- 23.1416** 13,5 cm / 8 mm
- 23.1420** 17,0 cm / 2 mm
- 23.1421** 17,0 cm / 3 mm
- 23.1422** 17,0 cm / 4 mm
- 23.1423** 17,0 cm / 5 mm
- 23.1424** 17,0 cm / 6 mm
- 23.1425** 17,0 cm / 7 mm
- 23.1426** 17,0 cm / 8 mm

PARTSCH



- 23.1440** 13,5 cm / 2 mm
- 23.1441** 13,5 cm / 3 mm
- 23.1442** 13,5 cm / 4 mm
- 23.1443** 13,5 cm / 5 mm
- 23.1444** 13,5 cm / 6 mm
- 23.1445** 13,5 cm / 7 mm
- 23.1446** 13,5 cm / 8 mm
- 23.1450** 17,0 cm / 2 mm
- 23.1451** 17,0 cm / 3 mm
- 23.1452** 17,0 cm / 4 mm
- 23.1453** 17,0 cm / 5 mm
- 23.1454** 17,0 cm / 6 mm
- 23.1455** 17,0 cm / 7 mm
- 23.1456** 17,0 cm / 8 mm

PARTSCH



- 23.1458** 13,5 cm / 4 mm
- 23.1459** 13,5 cm / 6 mm
- 23.1460** 13,5 cm / 8 mm
- 23.1461** 13,5 cm / 10 mm
- 23.1462** 13,5 cm / 12 mm
- 23.1463** 13,5 cm / 14 mm
- 23.1464** 13,5 cm / 16 mm



- 23.1468** 13,5 cm / 4 mm
- 23.1469** 13,5 cm / 6 mm
- 23.1470** 13,5 cm / 8 mm
- 23.1471** 13,5 cm / 10 mm
- 23.1472** 13,5 cm / 12 mm
- 23.1473** 13,5 cm / 14 mm
- 23.1474** 13,5 cm / 16 mm



- 23.1478** 13,5 cm / 4 mm
- 23.1479** 13,5 cm / 6 mm
- 23.1480** 13,5 cm / 8 mm
- 23.1481** 13,5 cm / 10 mm
- 23.1482** 13,5 cm / 12 mm
- 23.1483** 13,5 cm / 14 mm
- 23.1484** 13,5 cm / 16 mm



- 23.1486 3 mm
- 23.1488 4 mm
- 23.1490 5 mm
- 23.1492 6 mm
- 23.1494 8 mm
- 23.1496 10 mm
- 23.1498 12 mm

HOKE
14 cm

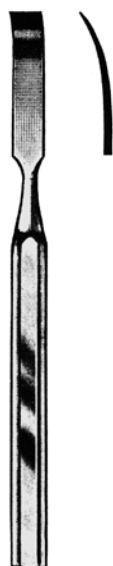

- 23.1487 3 mm
- 23.1489 4 mm
- 23.1491 5 mm
- 23.1493 6 mm
- 23.1495 8 mm
- 23.1497 10 mm
- 23.1499 12 mm

HOKE
14 cm

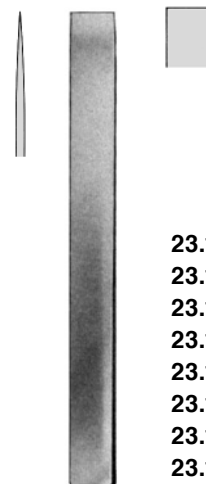

- 23.1500.2 2 mm
- 23.1500 3 mm
- 23.1501 4 mm
- 23.1503 6 mm
- 23.1504 8 mm
- 23.1505 10 mm
- 23.1506 12 mm
- 23.1507 15 mm

MINI-LAMBOTTE
12,5 cm

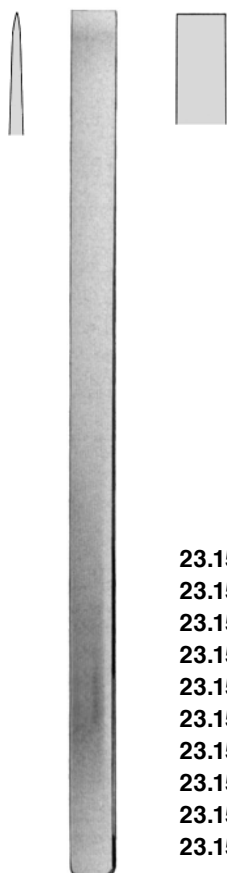

- 23.1509 4 mm
- 23.1510 6 mm
- 23.1511 13 mm
- 23.1512 15 mm
- 23.1513 20 mm
- 23.1514 25 mm
- 23.1515 30 mm
- 23.1516 38 mm
- 23.1517 44 mm
- 23.1518 50 mm

LAMBOTTE
25 cm

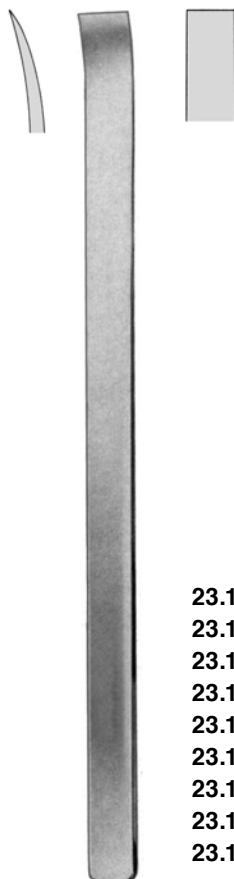

- 23.1520 6 mm
- 23.1521 13 mm
- 23.1522 15 mm
- 23.1523 20 mm
- 23.1524 25 mm
- 23.1525 30 mm
- 23.1526 38 mm
- 23.1527 44 mm
- 23.1528 50 mm

LAMBOTTE
25 cm

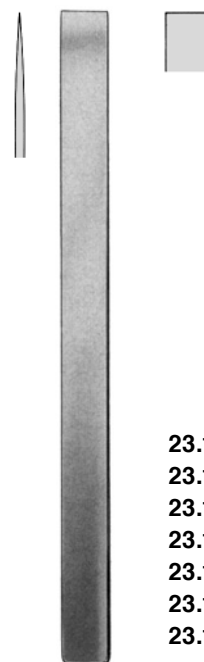

- 23.1530 3 mm
- 23.1531 4 mm
- 23.1532 6 mm
- 23.1533 8 mm
- 23.1534 10 mm
- 23.1535 12 mm
- 23.1536 15 mm

MINI-LAMBOTTE
17 cm



- 23.1540 4 mm
- 23.1541 6 mm
- 23.1542 8 mm
- 23.1543 10 mm
- 23.1544 12 mm
- 23.1545 14 mm

ALEXANDER
 17,5 cm



- 23.1550 4 mm
- 23.1551 6 mm
- 23.1552 8 mm
- 23.1553 10 mm
- 23.1554 12 mm
- 23.1555 14 mm

ALEXANDER
 18 cm



- 23.1560 4 mm
- 23.1561 6 mm
- 23.1562 8 mm
- 23.1563 10 mm
- 23.1564 12 mm
- 23.1565 14 mm

ALEXANDER
 17,5 cm



- 23.1570 6 mm
- 23.1579 8 mm
- 23.1580 10 mm
- 23.1578 12 mm
- 23.1581 15 mm
- 23.1582 20 mm
- 23.1583 25 mm
- 23.1584 30 mm

STILLE
 20 cm



- 23.1589 8 mm
- 23.1590 10 mm
- 23.1588 12 mm
- 23.1591 15 mm
- 23.1592 20 mm
- 23.1593 25 mm
- 23.1594 30 mm

STILLE
 20 cm



- 23.1595 8 mm
- 23.1596 10 mm
- 23.1597 12 mm
- 23.1598 15 mm
- 23.1599 20 mm
- 23.1600 25 mm

STILLE
 20 cm



- 23.1604 8 mm
- 23.1605 10 mm
- 23.1606 12 mm
- 23.1607 15 mm
- 23.1608 20 mm
- 23.1609 25 mm

STILLE
 20 cm

**MEISSEL, OSTEOTOME, HOHLMEISSEL
CHISELS, OSTEOTOMES, GOUGES
CISEAUX-BURINS, CINCELLES, GOUGES
CINCELLES, GUBIAS, OSTEOTOMOS
SCALPELLI, OSTEOTOMI, SGORBIE**

PRO-MED ist Ihnen behilflich bei der Zusammenstellung von Operationsbestecken für die verschiedensten Disziplinen. Fragen Sie nach unseren vorbereiteten OP-Bestecken.

For your convenience a wide variety of Suggested Operating Sets for most general and specialized procedures is available from **PRO-MED**. Please contact us or your local dealer.

PRO-MED vous propose de multiples compositions de boîtes opératoires multidisciplinaires. Demandez nos suggestions pour de nombreuses interventions.

PRO-MED le ayuda en componer varias cajas de instrumentos quirúrgicos. Pregunte por nuestro instrumental quirúrgico preparado.

Per la vostra comodità **PRO-MED** Vi aiuta nella raccolta di strumenti chirurgici per le varie discipline. Vi preghiamo di chiedere informazioni sui nostri set di strumenti chirurgici già preparati.

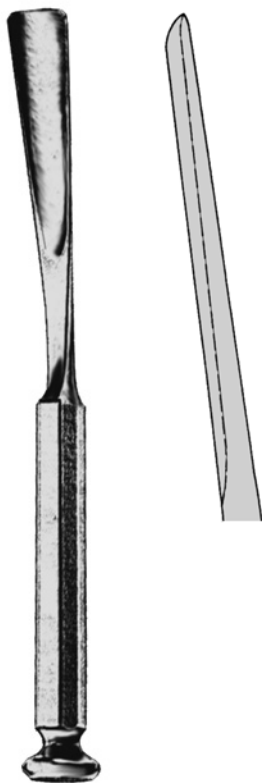

WALTER

23.1615 10 mm

23.1617 15 mm

20 cm



LEXER

23.1620 20 mm

25 cm



LEXER

23.1621 16 mm

26 cm

mit Ferrozellgriff
with artificial wood-handles
avec manches en bois artificiel
con mangos de madera artificial
con manici in materia plastica

mit Ferrozellgriff
 with artificial wood-handles
 avec manches en bois artificiel
 con mangos de madera artificial
 con manici in materia plastica

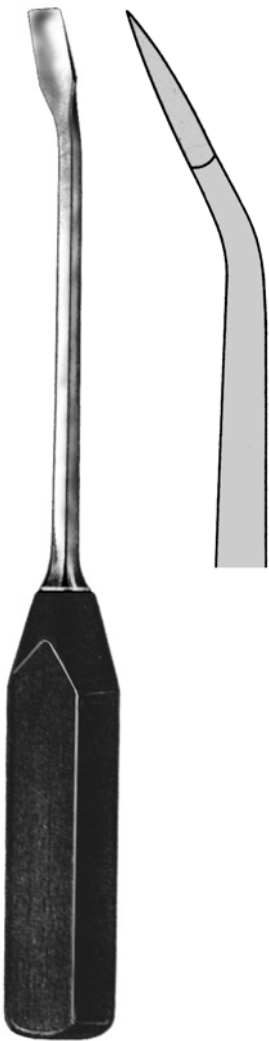

LEXER
 23.1623 10 mm
 23.1624 15 mm
 27 cm

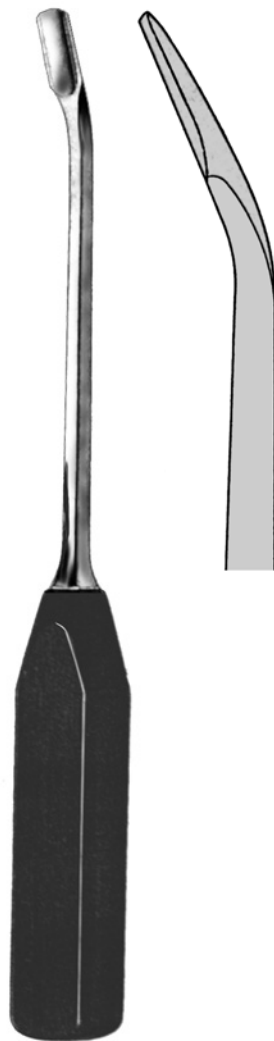

LEXER
 23.1625 10 mm
 23.1626 15 mm
 27 cm



MINI-LEXER
 23.1630 4 mm
 23.1631 6 mm
 23.1632 8 mm
 23.1633 10 mm
 23.1634 12 mm
 18 cm



MINI-LEXER
 23.1640 4 mm
 23.1641 6 mm
 23.1642 8 mm
 23.1643 10 mm
 23.1644 12 mm
 18 cm

**MEISSEL, OSTEOTOME, HOHLMEISSEL
CHISELS, OSTEOTOMES, GOUGES
CISEAUX-BURINS, CINCELLES, GOUGES
CINCELLES, GUBIAS, OSTEOTOMOS
SCALPELLI, OSTEOTOMI, SGORBIE**

mit Ferrozellgriff
with artificial wood-handles
avec manches en bois artificiel
con mangos de madera artificial
con manici in materia plastica



- 23.1650 7 mm
- 23.1651 10 mm
- 23.1652 15 mm
- 23.1653 20 mm
- 23.1654 25 mm
- 23.1655 30 mm

LEXER
22 cm



- 23.1660 7 mm
- 23.1661 10 mm
- 23.1662 15 mm
- 23.1663 20 mm
- 23.1664 25 mm
- 23.1665 30 mm

LEXER
22 cm

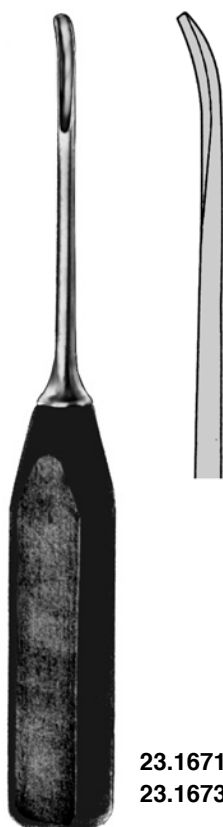

- 23.1671 5,5 mm
- 23.1673 9,0 mm

ZIELKE
23 cm

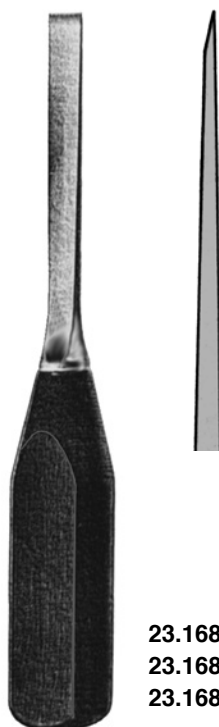

- 23.1680 10 mm
- 23.1682 15 mm
- 23.1684 20 mm

OSTEOTOME
20 cm

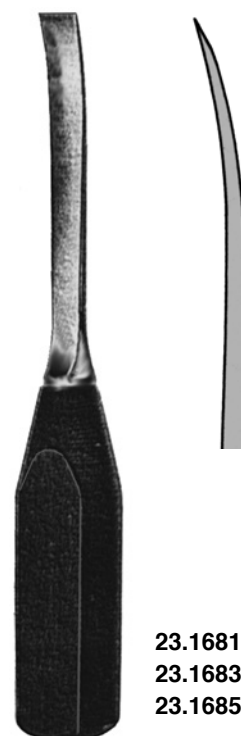

- 23.1681 10 mm
- 23.1683 15 mm
- 23.1685 20 mm

OSTEOTOME
20 cm

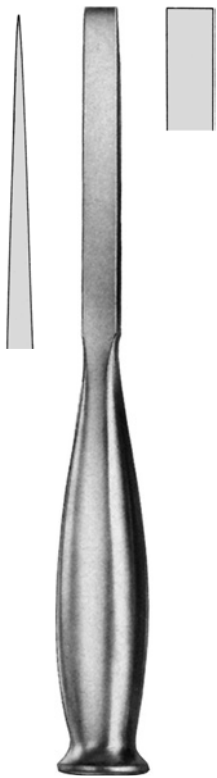

SMITH-PETERSEN
20 cm

- 23.1700 6 mm
- 23.1702 9 mm
- 23.1704 13 mm
- 23.1706 16 mm
- 23.1708 19 mm
- 23.1710 25 mm
- 23.1712 32 mm

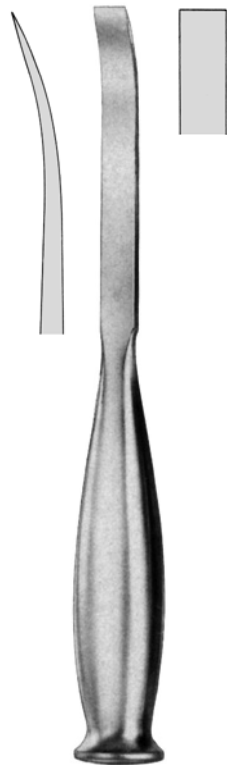

SMITH-PETERSEN
20 cm

- 23.1701 6 mm
- 23.1703 9 mm
- 23.1705 13 mm
- 23.1707 16 mm
- 23.1709 19 mm
- 23.1711 25 mm
- 23.1713 32 mm

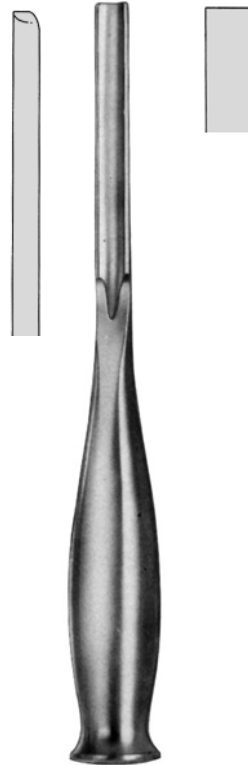

SMITH-PETERSEN
20 cm

- 23.1720 6 mm
- 23.1722 9 mm
- 23.1724 13 mm
- 23.1726 16 mm
- 23.1728 19 mm
- 23.1730 25 mm
- 23.1732 32 mm

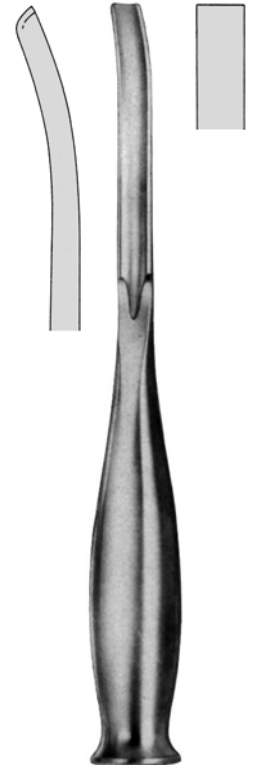

SMITH-PETERSEN
20 cm

- 23.1721 6 mm
- 23.1723 9 mm
- 23.1725 13 mm
- 23.1727 16 mm
- 23.1729 19 mm
- 23.1731 25 mm
- 23.1733 32 mm

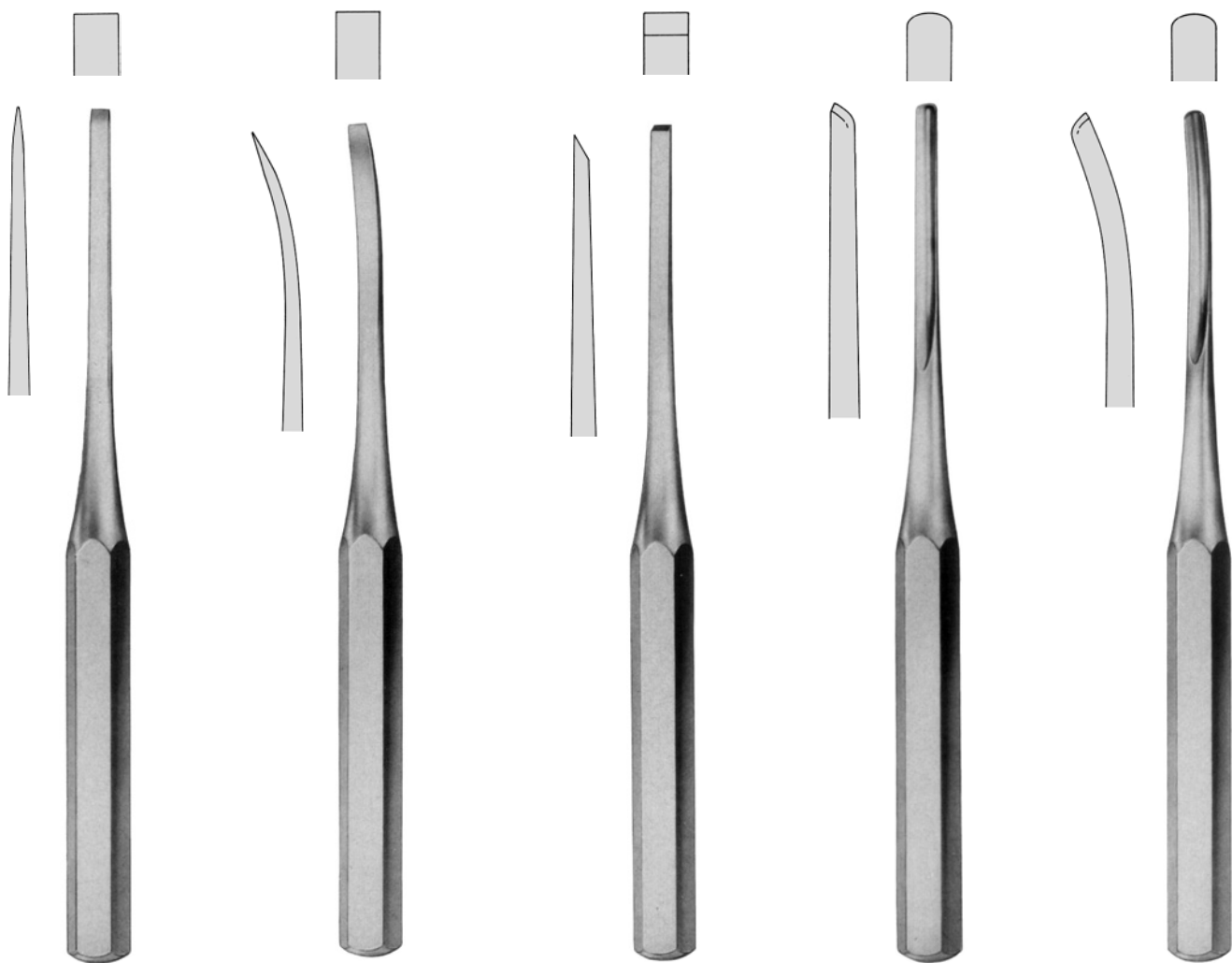

HIBBS

24 cm

- 23.1750 6 mm
- 23.1750.9 9 mm
- 23.1752 13 mm
- 23.1754 19 mm
- 23.1756 25 mm
- 23.1758 32 mm

HIBBS

24 cm

- 23.1751 6 mm
- 23.1751.9 9 mm
- 23.1753 13 mm
- 23.1755 19 mm
- 23.1757 25 mm
- 23.1759 32 mm

HIBBS

24 cm

- 23.1770 6 mm
- 23.1770.9 9 mm
- 23.1772 13 mm
- 23.1774 19 mm
- 23.1776 25 mm
- 23.1778 32 mm

HIBBS

24 cm

- 23.1790 6 mm
- 23.1790.9 9 mm
- 23.1792 13 mm
- 23.1794 19 mm
- 23.1796 25 mm
- 23.1798 32 mm

HIBBS

24 cm

- 23.1791 6 mm
- 23.1791.9 9 mm
- 23.1793 13 mm
- 23.1795 19 mm
- 23.1797 25 mm
- 23.1799 32 mm

mit Ferrozellgriff
with artificial wood-handles
avec manches en bois artificiel
con mangos de madera artificial
con manici in materia plastica



COBB
23.1800
28 cm / 8 mm



COBB
23.1801
28 cm / 8 mm



COBB
23.1802
28 cm / 8 mm



COBB
23.1803
28 cm / 8 mm

MEISSEL, OSTEOTOME, HOHLMEISSEL
CHISELS, OSTEOTOMES, GOUGES
CISEAUX-BURINS, CINCELLES, GOUGES
CINCELLES, GUBIAS, OSTEOTOMOS
SCALPELLI, OSTEOTOMI, SGORBIE

Metallgriff
metal handle
manche en métal
mango metallico
Manico metallico



COBB
23.1806
28 cm / 8 mm



COBB
23.1807
28 cm / 8 mm



COBB
23.1808
28 cm / 8 mm



COBB
23.1809
28 cm / 8 mm

mit Ferrozellgriff
 with artificial wood-handles
 avec manches en bois artificiel
 con mangos de madera artificial
 con manici in materia plastica



WAGNER
 34 cm



9 mm



15 mm

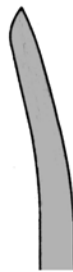

23.1810

aufgebogen
 inclined forward
 coudé en avant
 curva hacia adelante
 curva in alto



23.1812

rückwärts gebogen
 inclined backward
 coudé en arrière
 curva hacia atrás
 curva all'indietro



23.1814

gerade
 straight
 droite
 recta
 retto

23.1811

23.1813

23.1815

MEISSEL, OSTEOTOME, HOHLMEISSEL
CHISELS, OSTEOTOMES, GOUGES
CISEAUX-BURINS, CINCELLES, GOUGES
CINCELLES, GUBIAS, OSTEOTOMOS
SCALPELLI, OSTEOTOMI, SGORBIE

mit Ferrozellgriff
with artificial wood-handles
avec manches en bois artificiel
con mangos de madera artificial
con manici in materia plastica

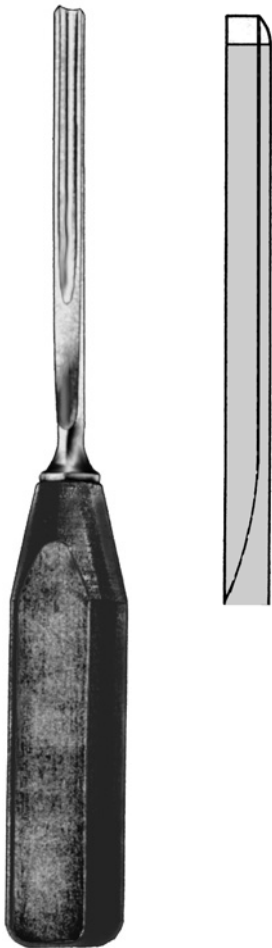

SPONGIOSA

25 cm

23.1820 5 mm

23.1822 10 mm

23.1824 15 mm

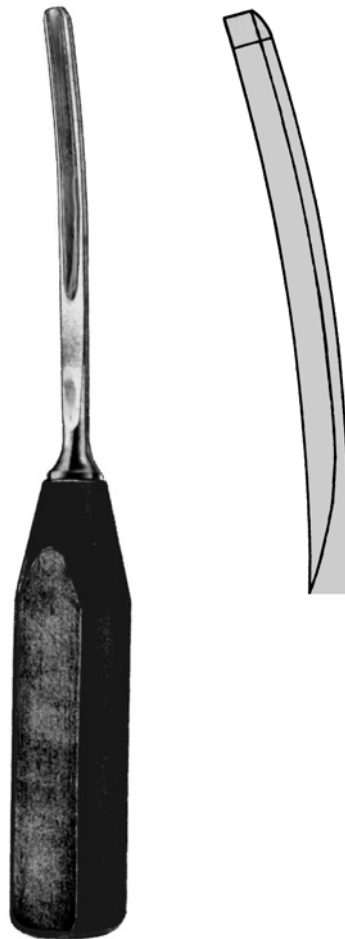

SPONGIOSA

25 cm

23.1821 5 mm

23.1823 10 mm

23.1825 15 mm



COBB

28 cm
23.1830 6 mm
23.1832 10 mm
23.1834 13 mm
23.1836 16 mm
23.1838 19 mm
23.1840 25 mm
23.1842 32 mm



COBB

28 cm
23.1831 6 mm
23.1833 10 mm
23.1835 13 mm
23.1837 16 mm
23.1839 19 mm
23.1841 25 mm
23.1843 32 mm



COBB

28 cm
23.1850 6 mm
23.1852 10 mm
23.1854 13 mm
23.1856 16 mm
23.1858 19 mm
23.1860 25 mm
23.1862 32 mm



COBB

28 cm
23.1851 6 mm
23.1853 10 mm
23.1855 13 mm
23.1857 16 mm
23.1859 19 mm
23.1861 25 mm
23.1863 32 mm



DAHMEN

30 cm

23.1940	4 mm
23.1942	5 mm
23.1944	6 mm
23.1946	8 mm
23.1948	10 mm
23.1950	12 mm
23.1952	15 mm
23.1954	20 mm
23.1956	22 mm
23.1958	25 mm

DAHMEN

30 cm

23.1941	4 mm
23.1943	5 mm
23.1945	6 mm
23.1947	8 mm
23.1949	10 mm
23.1951	12 mm
23.1953	15 mm
23.1955	20 mm
23.1957	22 mm
23.1959	25 mm

DAHMEN

30 cm

23.1960	4 mm
23.1962	5 mm
23.1964	6 mm
23.1966	8 mm
23.1968	10 mm
23.1970	12 mm
23.1972	15 mm
23.1974	20 mm
23.1976	22 mm
23.1978	25 mm

DAHMEN

30 cm

23.1961	4 mm
23.1963	5 mm
23.1965	6 mm
23.1967	8 mm
23.1969	10 mm
23.1971	12 mm
23.1973	15 mm
23.1975	20 mm
23.1977	22 mm
23.1979	25 mm



23.1980

Meißelgriff für auswechselbare Klingen
 Handle for interchangeable blades
 Manche pour lames interchangeables
 Mango para hojas intercambiables
 Manico per lame intercambiabili



23.1982
 8,5 cm, 5 mm



23.1983
 8,5 cm, 10 mm



23.1984
 8,5 cm, 16 mm

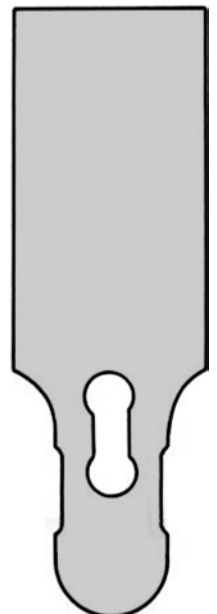

23.1985
 8,5 cm, 25 mm

Osteotomklingen / Chisel blades / Lames ciseaux burin / Hojas de cincel / Lame scalpello



23.1986
 8,5 cm, 5 mm



23.1987
 8,5 cm, 10 mm



23.1988
 8,5 cm, 16 mm

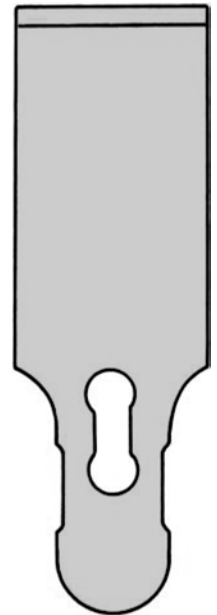

23.1989
 8,5 cm, 25 mm

Flachmeißelklingen / Chisel blades / Lames ciseaux burin / Hojas de cincel / Lame scalpello



Hohlmeißelklingen
 Gouge blades
 Lames gouges
 Hojas de gubia
 Lame sgorbie

135x25 mm

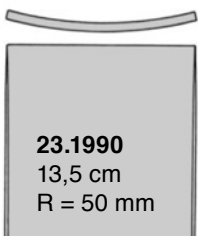

23.1990
 13,5 cm
 R = 50 mm

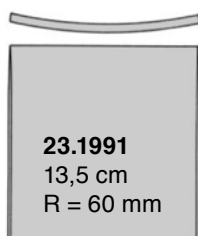

23.1991
 13,5 cm
 R = 60 mm

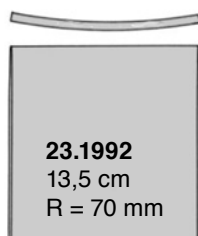

23.1992
 13,5 cm
 R = 70 mm

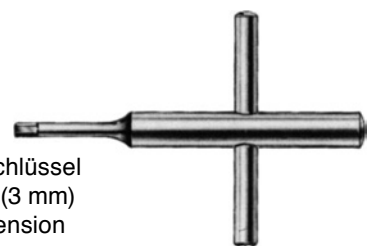

Spannschlüssel
 Wrench (3 mm)
 Clé de tension
 Llave tensora
 Chiave per dadi

23.1993 3 mm

REPOSITIONSZANGEN
REPOSITION FORCEPS
PINCES A REDUCTION
PINZAS PARA REDUCCION
TENAGLIE PER REPOSITIONI



23.2021
 9,5 cm



23.2001 13,5 cm
23.2006 15,0 cm
 für Kleinfragmente
 for small fragments
 pour petits fragments
 para fragmentos pequeños
 per piccoli frammenti



REILL
23.2002
 17 cm



23.2004
 14 cm
 Fingerknochen-Haltezange
 Phalangeal Forceps
 Pince pour phalanges
 Pinza para coger falanges
 Pinza per falange

zur temporären Fixierung von Fragmenten
 for temporary fixation of fragments
 pour fixation temporaire des fragments
 para fijación temporal fragmentos
 per fissazione temporaneo dei frammenti



23.2005
 12 cm



SCARF
23.2007
 16 cm

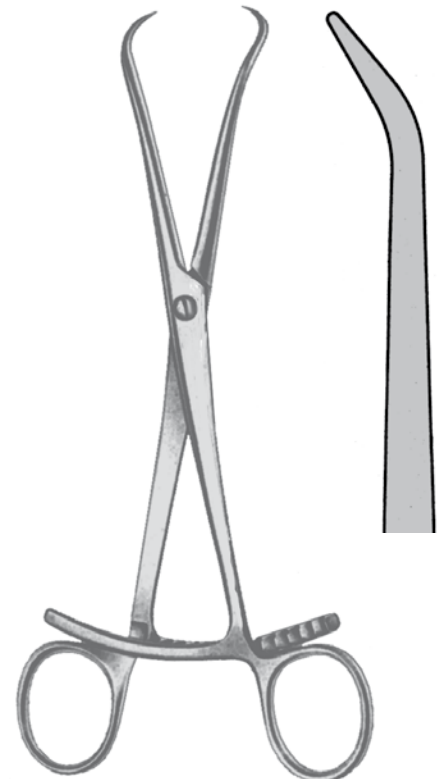

23.2050
 20 cm

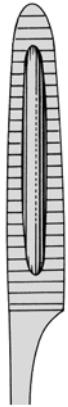

23.2100
20 cm



23.2101
20 cm

Sequesterzangen
 Sequestrum Forceps
 Pinces à séquestre
 Pinzas para secuestro
 Pinze per sequestri

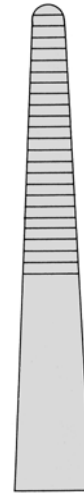

VAN BUREN
23.2110 23 cm



SETTER
23.2040
13,5 cm



SETTER

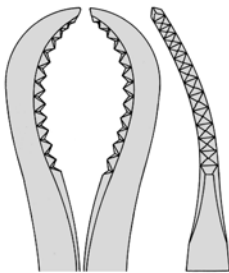

23.2042
16 cm

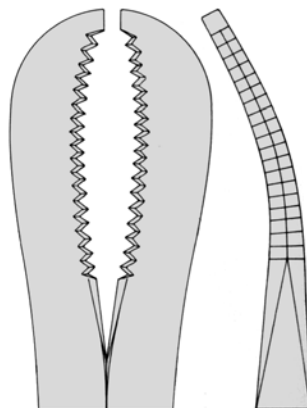

23.2044
22 cm

Repositionszangen
 Reposition Forceps
 Pinces à réduction
 Pinzas para reducción
 Tenaglie per riposizione



LEWIN
23.2010
18 cm

KNOCHENHALTEZANGEN
BONE HOLDING FORCEPS
DAVIERS A OS
PINZAS PRENSORAS DE HUESOS
TENAGLIE PER OSSA



DINGMAN

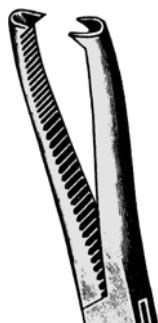

23.2200
19 cm

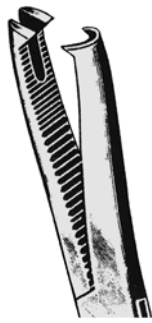

DINGMAN modif.
23.2205
19 cm



SEMB
23.2210 19 cm

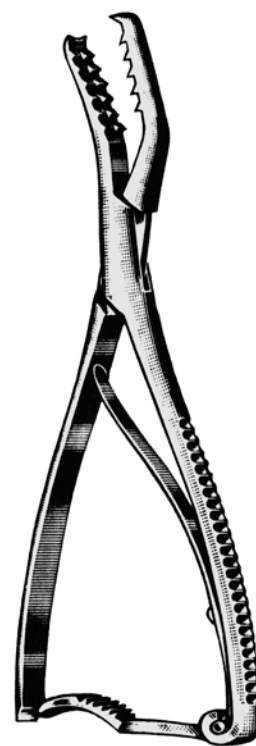

SEMB
23.2211 19 cm

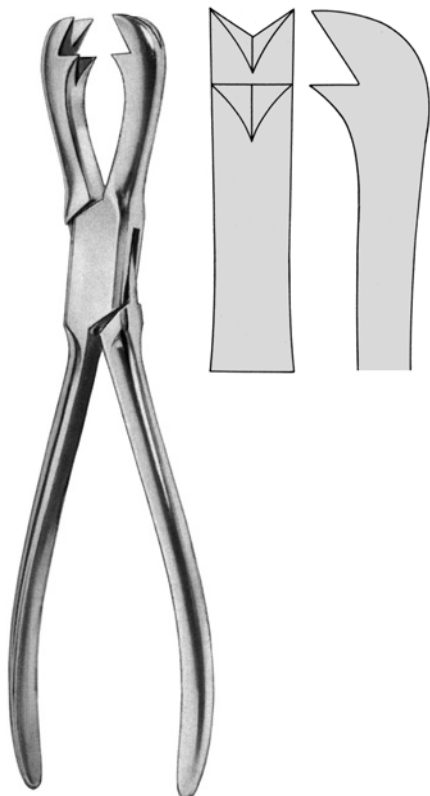

FERGUSON
23.2220 21 cm



23.2224 20 cm



FARABEUF
23.2232 23 cm
23.2234 26 cm



FARABEU-F-LAMBOTTE
 23.2235 26 cm

verstellbar
 adjustable
 ajustable
 ajustable
 regolabile

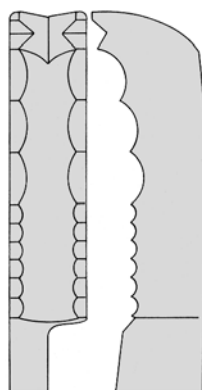

LANGENBECK
 23.2240 21 cm



KERN
 23.2250 14 cm
 23.2252 17 cm
 23.2254 21 cm

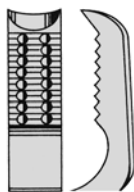

KERN
 23.2251 14 cm
 23.2253 17 cm
 23.2255 21 cm

verstellbar
 adjustable
 ajustable
 ajustable
 regolabile

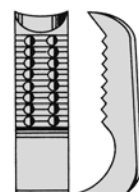

KNOCHENHALTEZANGEN
BONE HOLDING FORCEPS
DAVIERS A OS
PINZAS PRENSORAS DE HUESOS
TENAGLIE PER OSSA

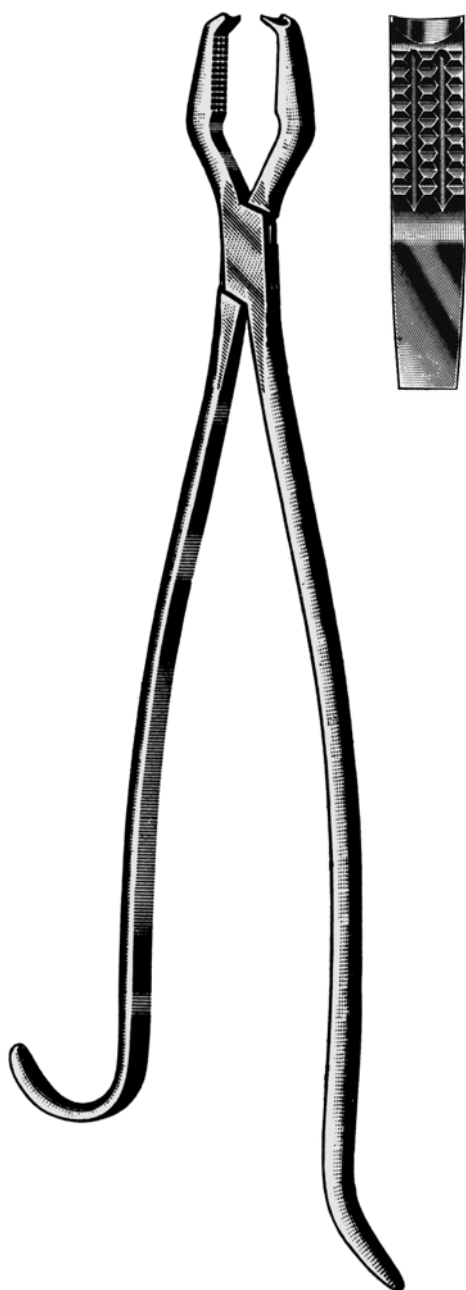

LANE
23.2260 33 cm
23.2262 45 cm

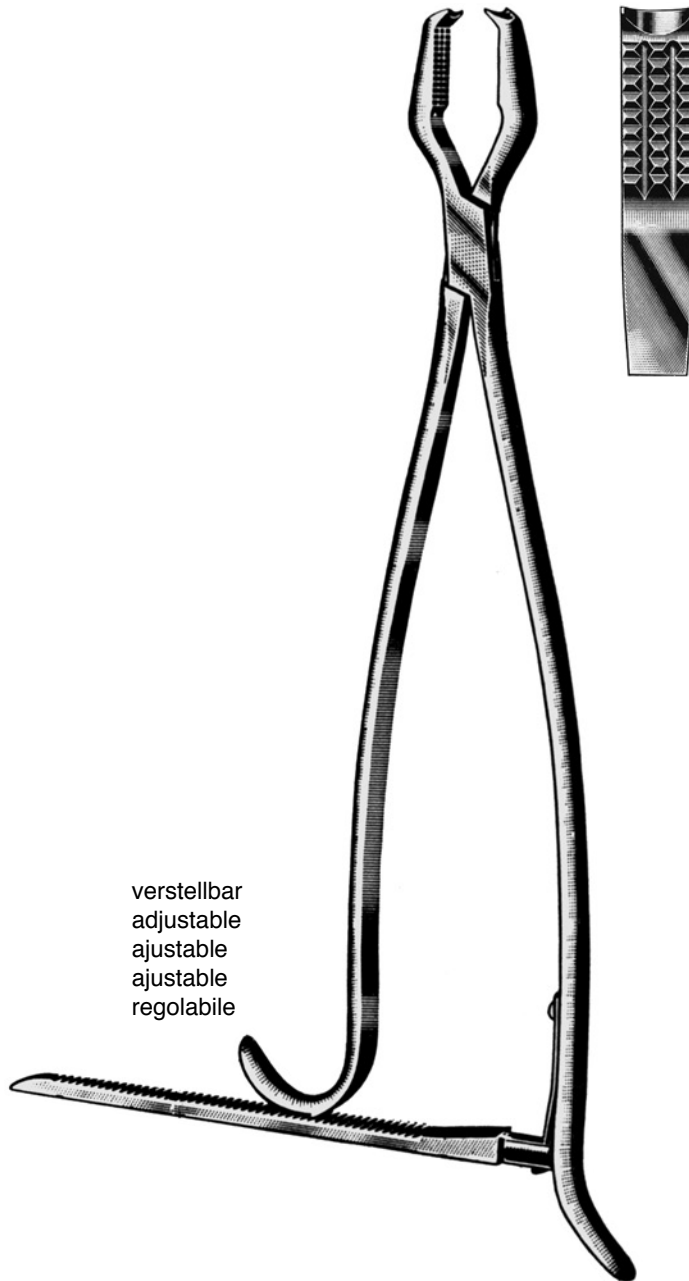

verstellbar
adjustable
ajustable
ajustable
regolabile

LANE
23.2261 33 cm
23.2263 45 cm



LAMBOTTE
 23.2270 22 cm
 23.2271 26 cm
 23.2272 30 cm

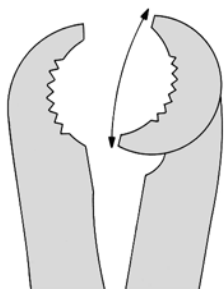

verstellbar
 adjustable
 ajustable
 ajustable
 regolabile

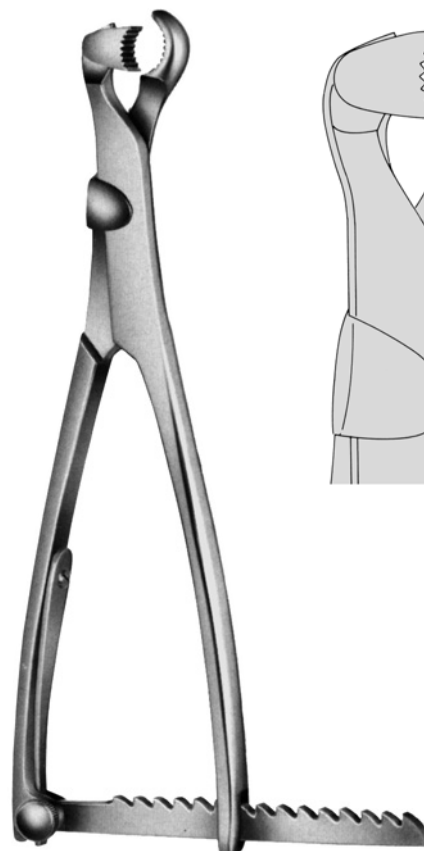

LAMBOTTE
 23.2274 26 cm

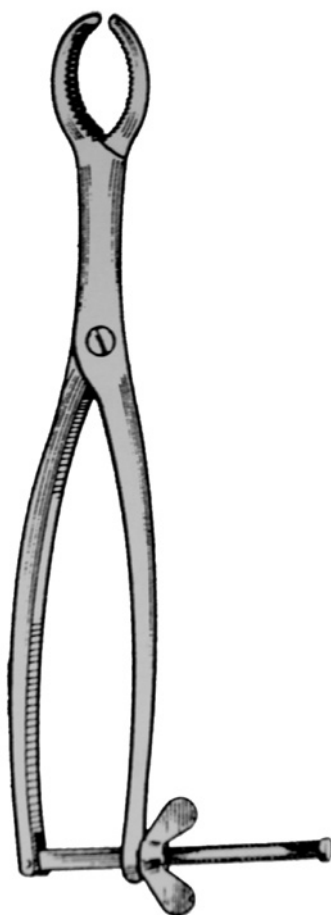
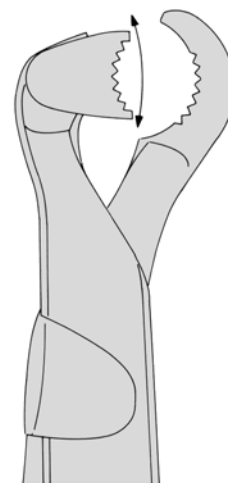

HEY GROVES
 23.2242 20cm
 23.2244 25cm
 23.2246 30cm

KNOCHENHALTEZANGEN
BONE HOLDING FORCEPS
DAVIERS A OS
PINZAS PRENSORAS DE HUESOS
TENAGLIE PER OSSA



VERBRUGGE-BABY
23.2280
 17 cm

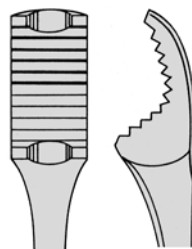
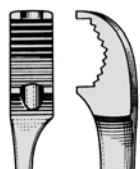

VERBRUGGE
23.2282
 25 cm

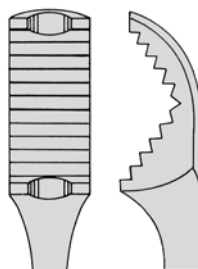

VERBRUGGE
23.2284
 26 cm

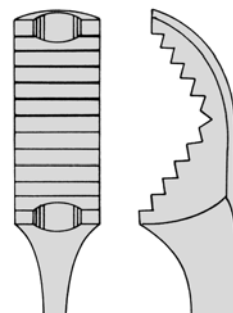

VERBRUGGE
23.2286
 27 cm



selbstzentrierend
 self-centering
 autocentrent
 autocentrante
 autocentrante



23.2290
 15 cm / 9 mm

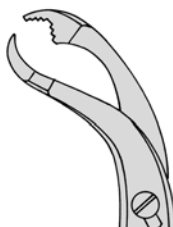

23.2292
 19 cm / 9 mm

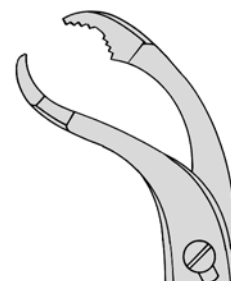

23.2294
 27 cm / 14 mm

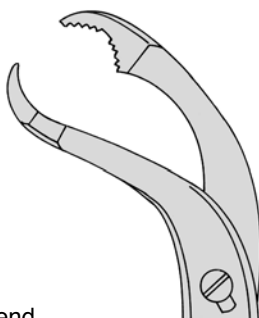

23.2296
 28 cm / 18 mm

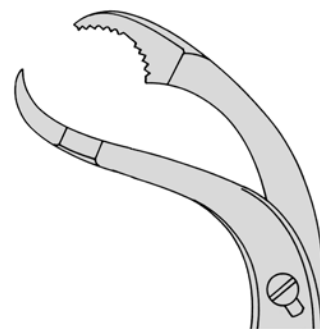

23.2298
 28 cm / 22 mm



ULRICH

verstellbar
 adjustable
 ajustable
 ajustable
 regolabile



23.2300 18 cm

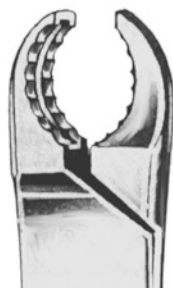

23.2302 23 cm



23.2304 25 cm

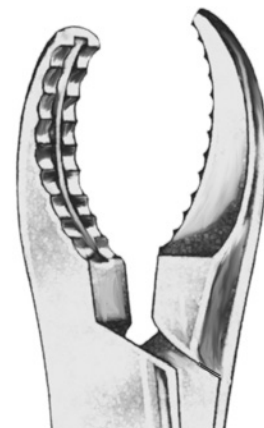

23.2306 28 cm



ULRICH



23.2305 25 cm



23.2307 28 cm

**KNOCHENHALTEKLAMMERN
BONE HOLDING CLAMPS
CLAMPS PORTE-OS
CLAMPS PORTA-HUESOS
TENAGLIE PER OSSA**



LOWMAN
23.2490 12 cm 1x1
23.2492 18 cm 1x1
23.2494 20 cm 1x1

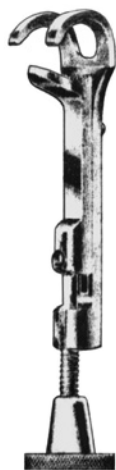

LOWMAN
23.2500 12 cm 1x2

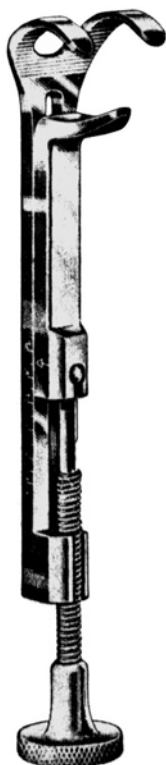

LOWMAN
23.2502 18 cm 1x2
23.2504 20 cm 1x2
23.2506 22 cm 1x2



LOWMAN-HOGLUND
23.2510 12 cm
23.2512 18 cm



LOWMAN-HOGLUND
23.2520 19 cm
23.2522 22 cm

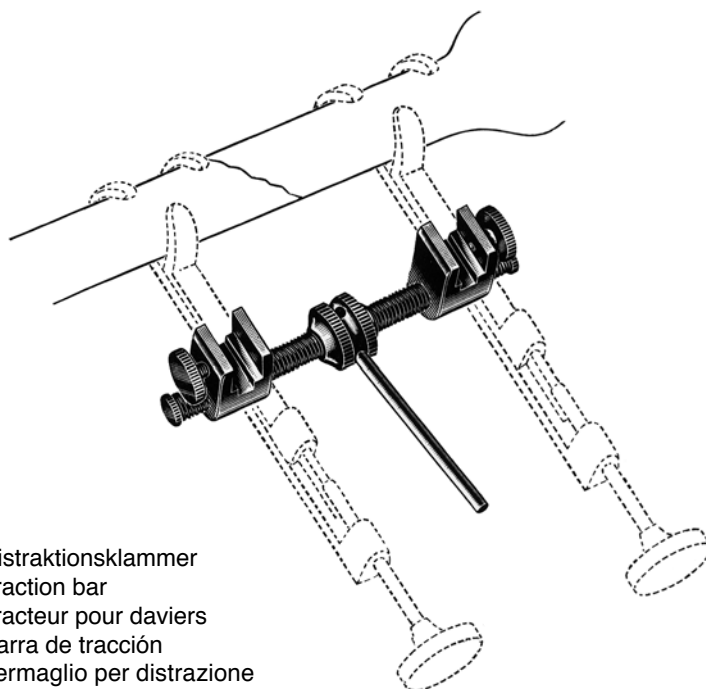

Distraktionsklammer
Traction bar
Tracteur pour daviers
Barra de tracción
Fermaglio per distrazione

GERSTER
23.2550

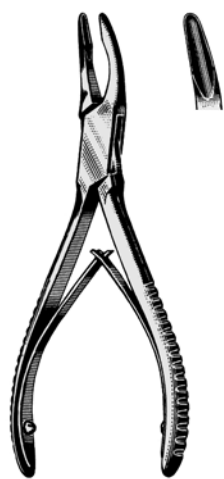

FRIEDMANN-MINI
 23.2600 12 cm



FRIEDMANN
 23.2601 14 cm



PEARSON
 23.2602 14,5 cm



LUER
 18 cm



23.2604

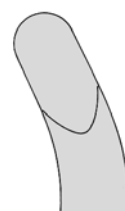

23.2605



LUER
 15 cm

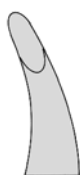

23.2603

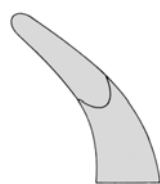

23.2606

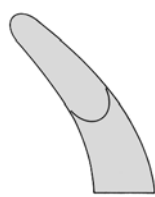

23.2607

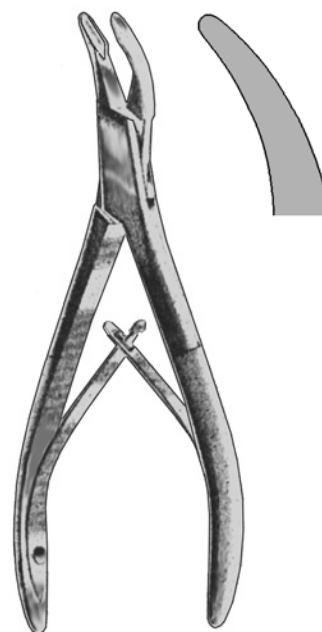

CICHERELLI
 23.2609 16,5 cm

HOHLMEISSELZANGEN
 BONE RONGEURS
 PINCES-GOUGES
 PINZAS-GUBIAS
 PINZE SGORBIE

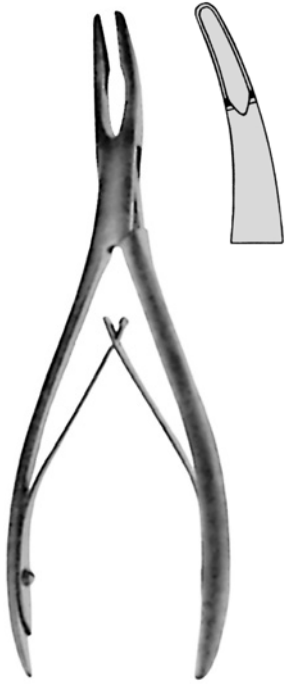

BEYER
 23.2611 18 cm



23.2620



23.2621



23.2622



23.2623

LEMPERT
 19 cm



23.2627



23.2629

STELLBRINK
 17 cm

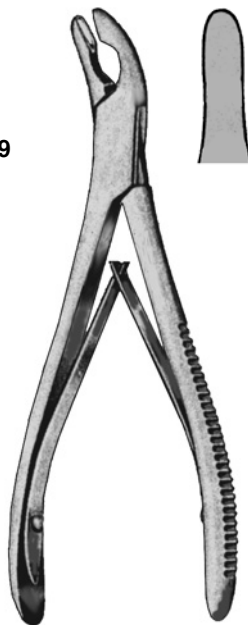

HAKANSSON
 23.2633
 16 cm



MEAD
 23.2635
 16 cm #1A

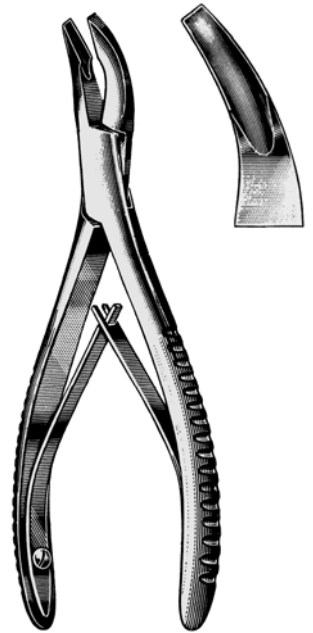

MEAD
 23.2636
 16 cm #2A

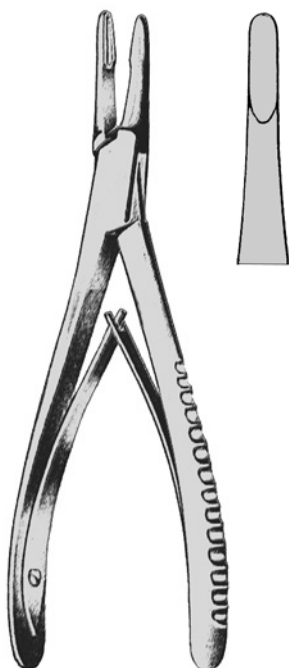

JANSEN
23.2640 18 cm



JANSEN
23.2641 18 cm

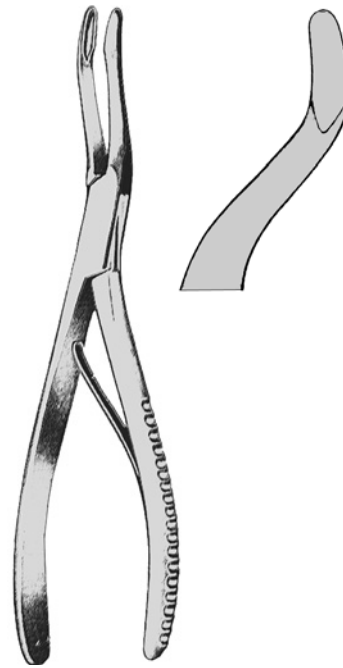

JANSEN
23.2643 18 cm



OLIVECRONA
23.2650 19,5 cm



PENNYBACKER
23.2656
20,5 cm



NORTHFIELD
23.2657
20,5 cm

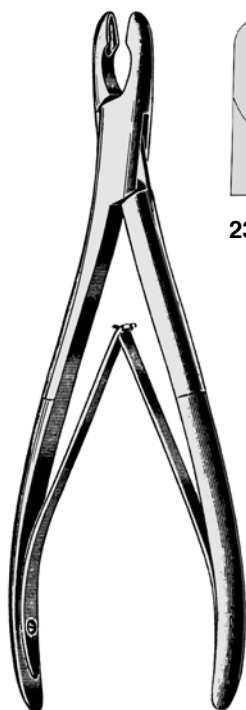

23.2660

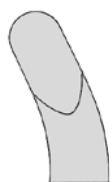

23.2661

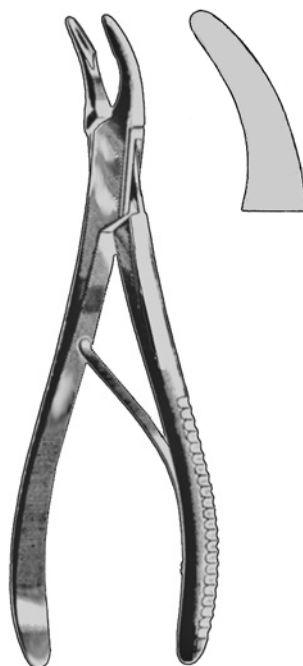

BANE
23.2665 18 cm

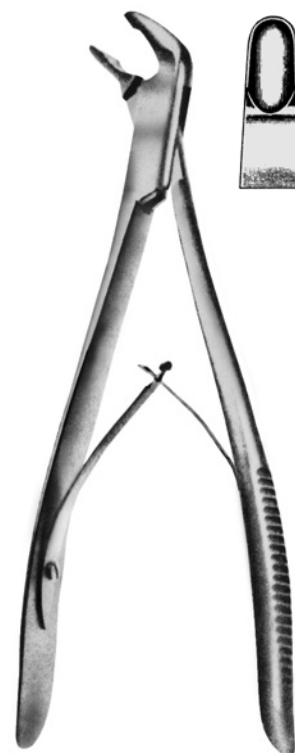

BACON
23.2667 20 cm



MARKWALDER
23.2670 20 cm

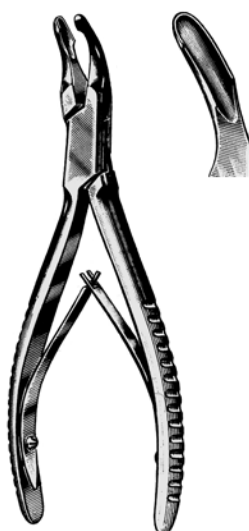

CLEVELAND
23.2680 14 cm #4

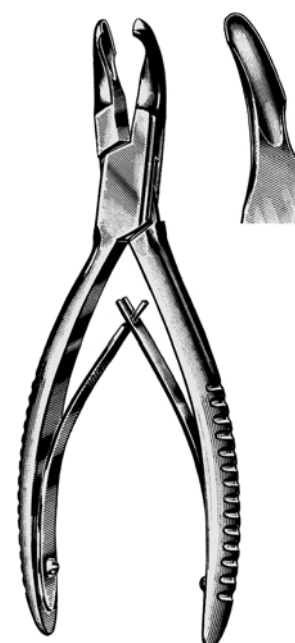

CLEVELAND
23.2682 17 cm #4A



BLUMENTHAL
 23.2685 15,5 cm 30°



BLUMENTHAL
 23.2687 15,5 cm 45°



BLUMENTHAL
 23.2689 15,5 cm 90°



HARTMANN
 23.2691 19 cm



BÖHLER
 15 cm

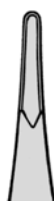

23.2802
 2 mm

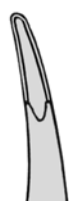

23.2803
 2 mm

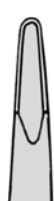

23.2804
 3 mm

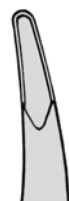

23.2805
 3 mm



BEYER
 23.2831 18 cm

HOHLMEISSELZANGEN
 BONE RONGEURS
 PINCES-GOUGES
 PINZAS-GUBIAS
 PINZE SGORBIE



ZAUFAL-JANSEN
 23.2833 18 cm



MAYFIELD
 23.2835 18,5 cm



MARQUARDT
 23.2837 20 cm

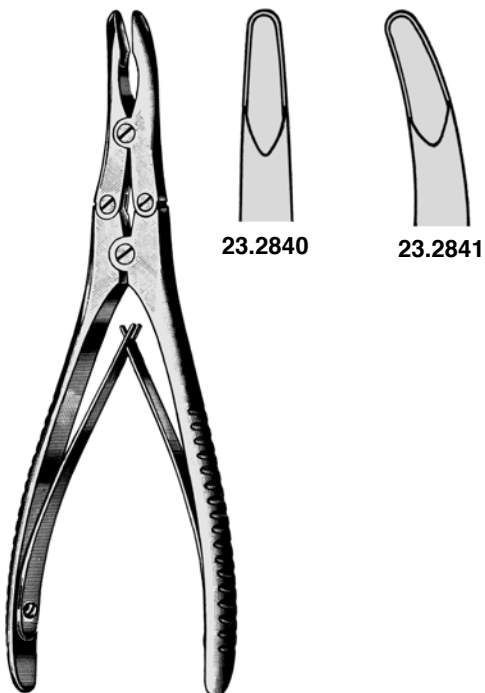

RUSKIN
 18 cm



RUSKIN
 23.2849 24 cm



STILLE-RUSKIN
 23.2851 24 cm

PRO-MED ist Ihnen behilflich bei der Zusammenstellung von Operationsbestecken für die verschiedensten Disziplinen. Fragen Sie nach unseren vorbereiteten OP-Bestecken.

For your convenience a wide variety of Suggested Operating Sets for most general and specialized procedures is available from **PRO-MED**. Please contact us or your local dealer.

PRO-MED vous propose de multiples compositions de boîtes opératoires multidisciplinaires. Demandez nos suggestions pour de nombreuses interventions.

PRO-MED le ayuda en componer varias cajas de instrumentos quirúrgicos. Pregunte por nuestro instrumental quirúrgico preparado.

Per la vostra comodità **PRO-MED** Vi aiuta nella raccolta di strumenti chirurgici per le varie discipline. Vi preghiamo di chiedere informazioni sui nostri set di strumenti chirurgici già preparati.

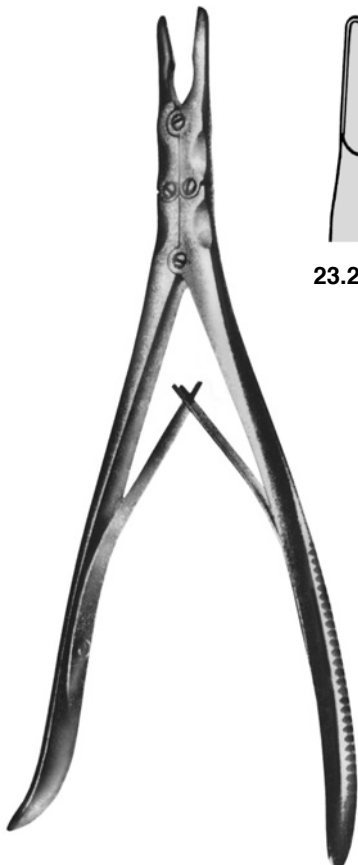

SMITH-PETERSEN
24 cm



23.2856

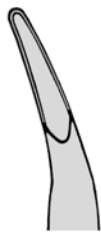

23.2857



23.2858



STILLE-LUER
22 cm



23.2880

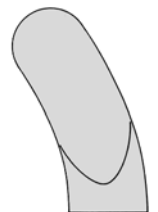

23.2881

HOHLMEISSELZANGEN
 BONE RONGEURS
 PINCES-GOUGES
 PINZAS-GUBIAS
 PINZE SGORBIE

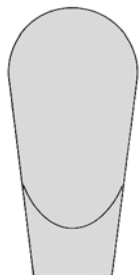

23.2882 27 cm
 23.2884 23 cm

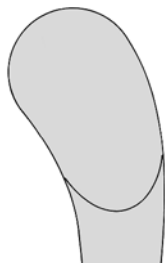

23.2883 27 cm
 23.2885 23 cm

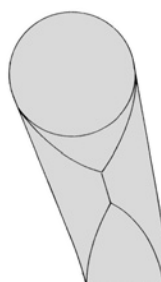

STILLE-LUER



SEMB
 23.2887
 23 cm



STILLE
 23.2890
 23 cm / 6 mm



FRYKHOLM
 23.2893 24 cm



LEKSELL-STILLE
 23 cm

23.2895
 5 mm

23.2896
 8 mm

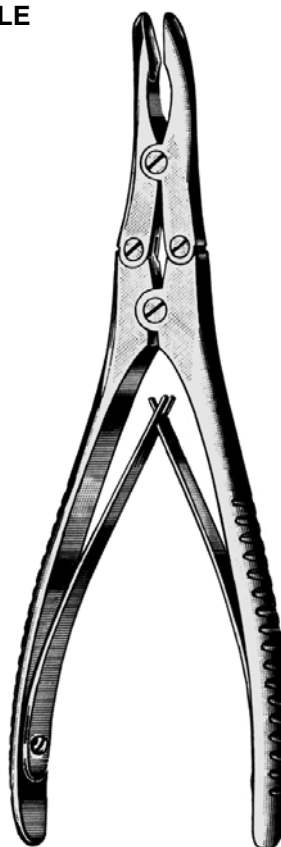

FULTON
 23 cm

23.2900
 7x18 mm

23.2901
 7x18 mm

**HOHLMEISSELZANGEN
BONE RONGEURS
PINCES-GOUGES
PINZAS-GUBIAS
PINZE SGORBIE**

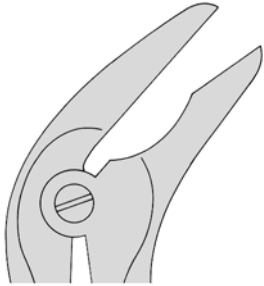

23.2902
2x10 mm



23.2903
3x10 mm



23.2904
4x10 mm

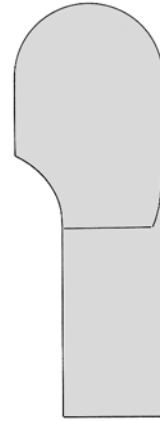

23.2910

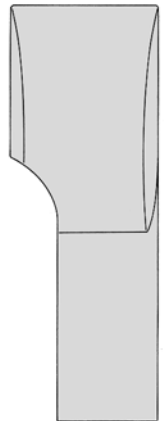

23.2912



ECHLIN
23 cm

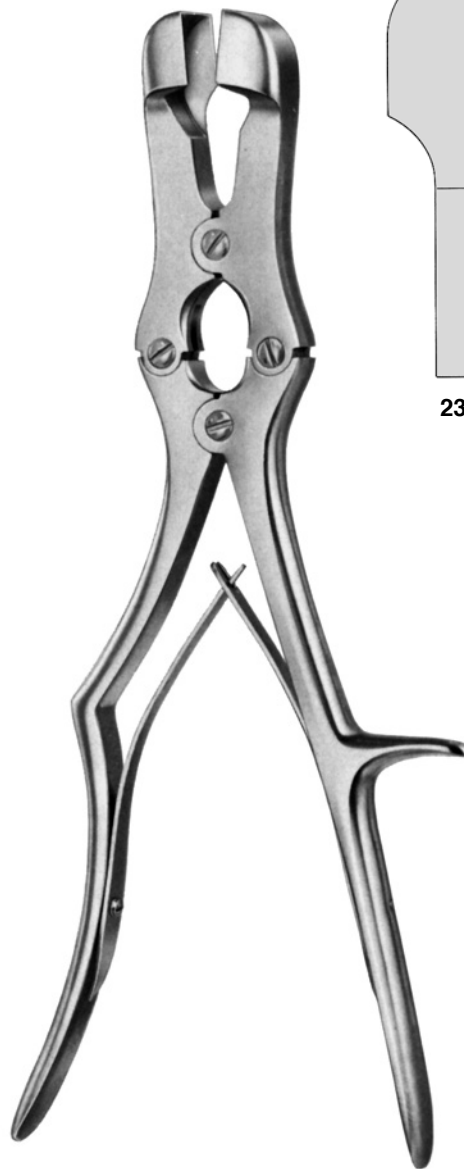

SAUERBRUCH
30 cm

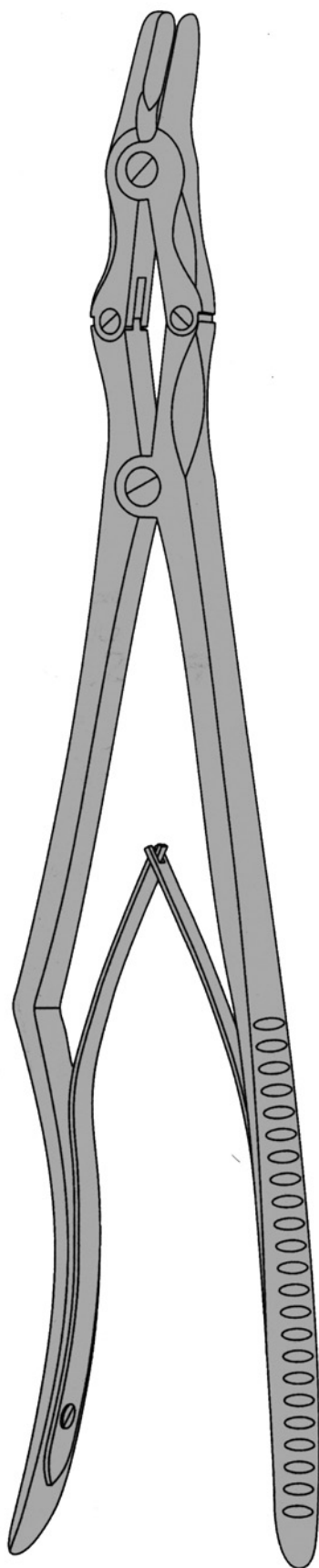

DALE
35 cm



23.2923
3 mm



23.2928
8 mm

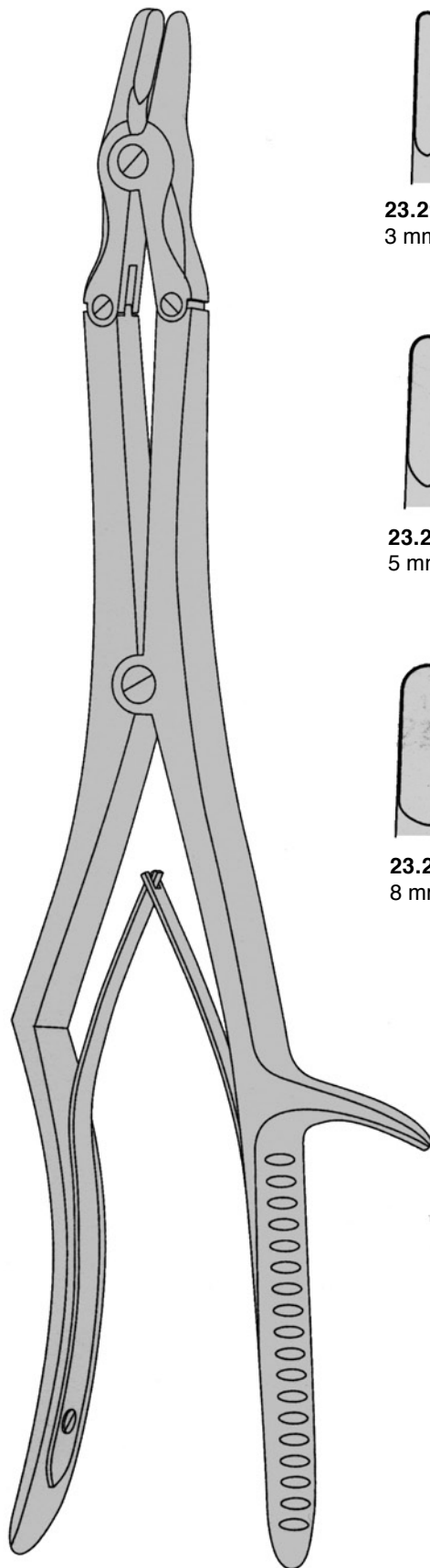

SYPERT
35 cm



23.2933
3 mm



23.2935
5 mm



23.2938
8 mm

**KNOCHENSPLITTERZANGEN
BONE CUTTING FORCEPS
PINCES COUPANTES A OS
PINZAS CORTANTES PARA HUESOS
CESOIE PER OSSA**



COTTLE-KAZANJIAN
23.3005 19 cm

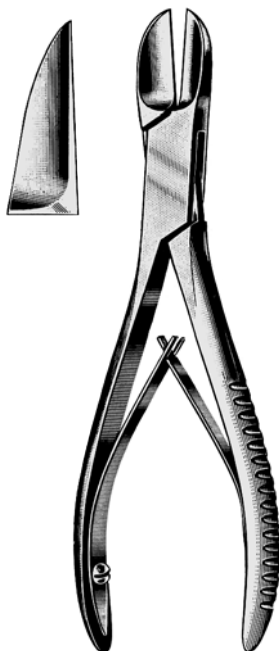

LISTON
23.3010 14 cm
23.3012 17 cm
23.3014 19 cm
23.3016 22 cm

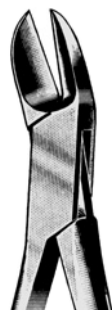

LISTON
23.3011 14 cm
23.3013 17 cm
23.3015 19 cm
23.3017 22 cm



LITTAUER-LISTON
23.3020 15 cm



CLEVELAND
23.3050 17 cm #5



CLEVELAND
23.3052 15 cm #5S



CLEVELAND
16 cm

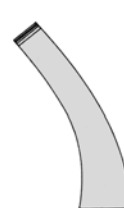

23.3054
6A

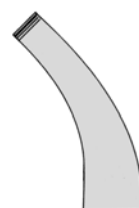

23.3056
6



BOEHLER
 23.3100 15 cm



BOEHLER
 23.3101 15 cm



McINDOE
 23.3111 17,5 cm



RUSKIN-LISTON
 19 cm

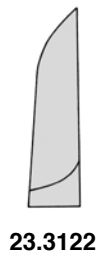

23.3122



23.3123



STILLE-LISTON
 27 cm



23.3150

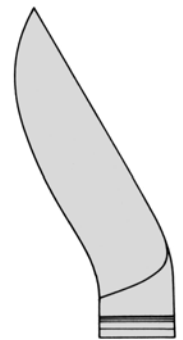

23.3151

KNOCHENSPLITTERZANGEN
BONE CUTTING FORCEPS
PINCES COUPANTES A OS
PINZAS CORTANTES PARA HUESOS
CESOIE PER OSSA

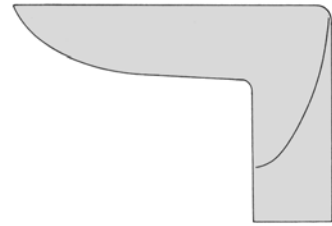
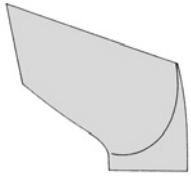

STILLE-HORSLEY
23.3161 27 cm



STILLE-HORSLEY
23.3162 27 cm 90°



VICKERS
23.3280

Handhalter - zur schnellen und sicheren Fixierung

Hand Fixator - for quick and efficient positioning in any desired position

Fixateur pour la main - immobilisation rapide et sécurisée dans chaque position

Fijador de mano - para fijación rápida y segura

Fissatore per mano - rapido e sicuro in ogniuno posizione

Wundspreizer für Handchirurgie
 Retractors for Hand Surgery
 Ecarteurs pour la chirurgie de la main
 Separadores para la cirugía de a mano
 Divaricatori per la chirurgia della mano

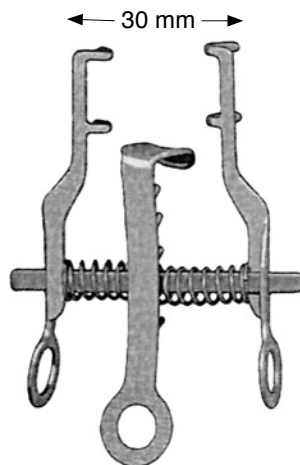

VICKERS
17.5050
 7,5 cm

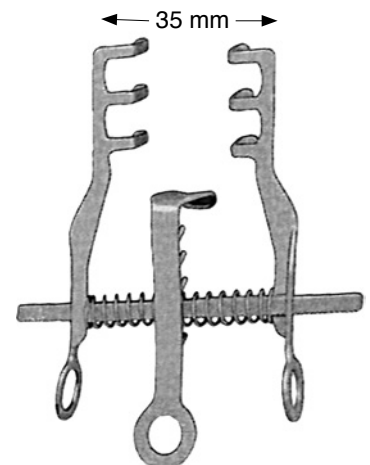

VICKERS
17.5052
 9 cm

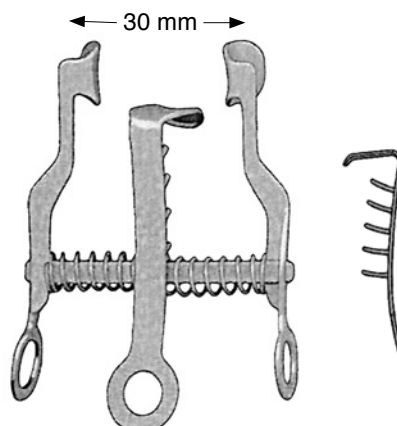

VICKERS
17.5054
 7,5 cm



17.5058
 10x12 mm



17.5059
 10x18 mm

INSTRUMENTE FÜR FINGER UND ZEHEN
FINGER- AND NAIL INSTRUMENTS
INSTRUMENTS A DOIGTS ET ORTEILS
INSTRUMENTOS PARA DEDOS
STRUMENTI PER DITO E DITO DEL PIEDE

Wundspreizer für Handchirurgie
 Retractors for Hand Surgery
 Ecarteurs pour la chirurgie de la main
 Separadores para la cirugía de a mano
 Divaricatori per la chirurgia della mano

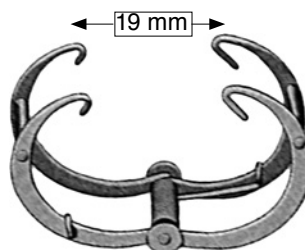

VICKERS
17.5060

geriefte Valven
 Serrated blades
 valves striées
 valvas estriadas
 valve con striatura



COX
17.5210 12 cm
 für Finger und Zehen
 Finger- and Toe Retractor
 pour doigts et orteils
 para dedos
 Mani di piombo

Bleihände
 Lead hands
 Mains operatoire de plomb
 Manos de plomo
 Mani di piombo

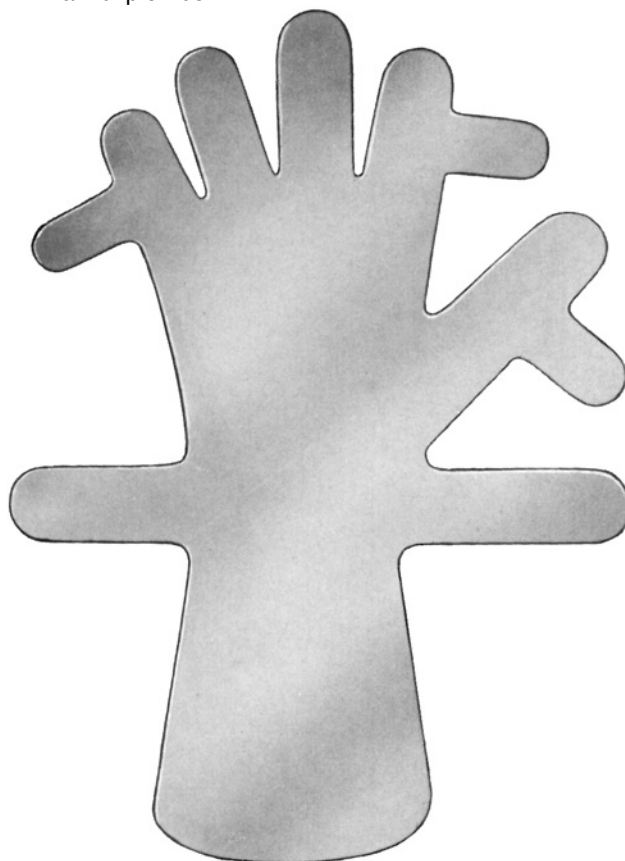

23.3290
 Kinder
 Child
 Enfant
 Ninos
 Bambini

23.3292
 Erwachsene
 Adult
 Adulte
 Adultos
 Adulti

Nagelbohrer komplett
 Nail Drill complete
 Perceuse à ongles, complète
 Taladro para uñas, completo
 Perforatore per unghie



58.0309
 Satz mit 3 Bohrern für 58.0300
 Set of 3 Drills for 58.0300
 Jeu de 3 forets p. 58.0300
 Juego de 3 brocas para 58.0300
 Set con 3 punte per 58.0300

58.0300
 mit 3 Bohrern
 with 3 drills
 avec 3 forets
 con 3 taladros
 con 3 punte

Nagelausreibzange
 Nail extracting Forceps
 Pince pour extraire les ongles
 Pinza para arrancar uñas
 Pinza per estrazione delle unghie



RADOLF
58.0320
 14 cm

Nagelspaltzange
 Nail Splitter
 Pince à fendre ongles
 Pinza cortar-uñas hendiduras
 Pinza taglianti per per fendere le unghie



ANVIL
58.0517
 14 cm

Nagelspaltscheren
 Nail Splitting Scissors
 Ciseaux à fendre les ongles
 Tijera para hender las uñas
 Forbici per fendere le unghie

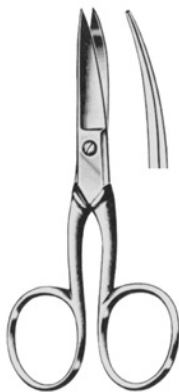

58.0621
 10 cm

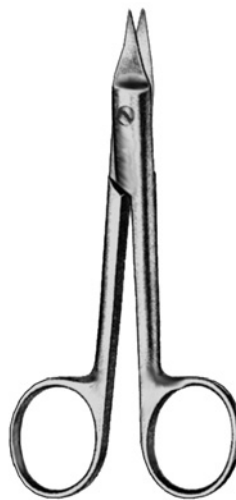

SYSTRUNK
58.0625
 13 cm



KÖNIG
58.0650 13 cm
58.0652 15 cm

58.0359



WALTON
58.0350
16 cm

58.0369



58.0360
17 cm

58.0379



WALTON-Select
58.0370
16 cm

für Gold, Silber, Platin, Titan, Stahl
for gold, silver, platinum, titanium, steel
pour or, argent, platine, titane, acier
para oro, plata, platino, titanio, acero
per oro, argento, platino, titanio, acciaio

58.0389



PRO-MED-Select
58.0380
17 cm

Sehnenfassinstrumente
Tendon Seizing Instruments
Pinces pour saisir les tendons
Pinzas para coger tendones
Pinze per afferrare tendini



CARROL
23.3201 11 cm

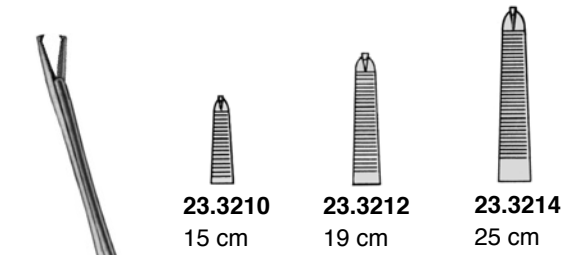

23.3210
15 cm

23.3212
19 cm

23.3214
25 cm

BRAND



LARSEN
10 cm

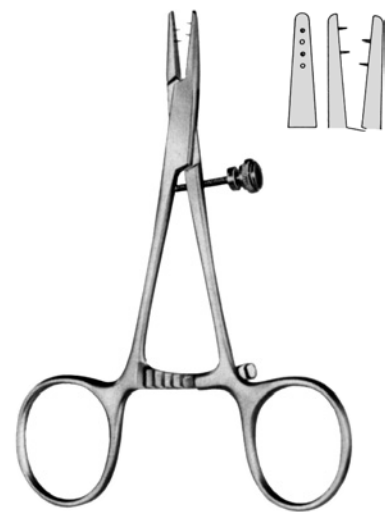
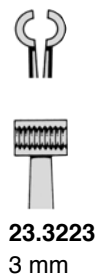
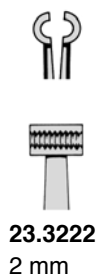

STEINMANN
23.3230 13 cm

SEHNENINSTRUMENTE
 TENDON INSTRUMENTS
 INSTRUMENTS POUR TENDONS
 INSTRUMENTOS PARA TENDONES
 STRUMENTI PER TENDINI



HERZ
 15,5 cm

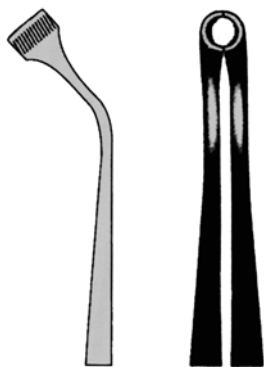

23.3218 3 mm

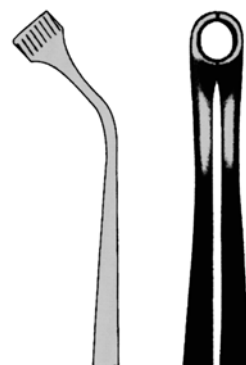

23.3219 4 mm

Sehnedurchziehungen
 Tendon Tunnelling Forceps
 Pinces passe-tendons
 Pinzas para passar tendones
 Pinze passa-tendini



KLEINERT-KUTZ
23.3216 20 cm

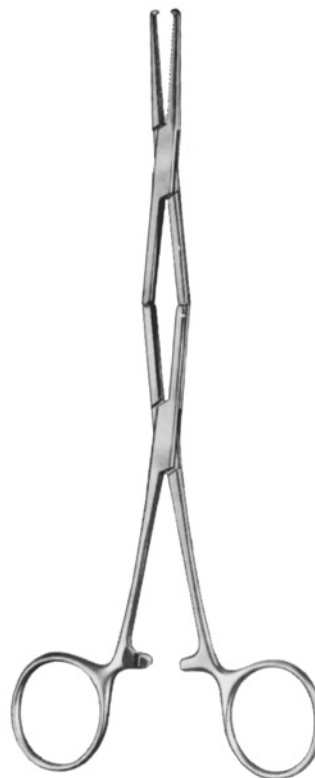

BUCK-GRAMCKO
 20,5cm

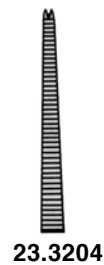

23.3204



23.3205

Sehneneinflechtklemmen
Tendon Interlacing Forceps
Pinces pour entrelacer les tendons
Pinzas para entrelazar tendones
Pinze per allacciare tendini

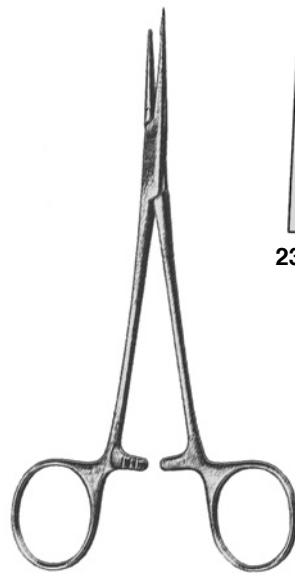

15 cm



23.3232



23.3233

Sehenschäler
Tendon Stripper
Strippers à tendons
Mondador de tendones
Enucleatore per tendini



BUNNELL

○
23.3242
2 mm

○
23.3243
3 mm

○
23.3244
4 mm

○
23.3245
5 mm

○
23.3246
6 mm

○
23.3247
7 mm

Sehnenführer
Tendon Guide
Conducteur à tendons
Conductor de tendones
Guida per tendini



BUNNELL
23.3250 23 cm, 5 mmØ



BRAND



23.3253
30 cm,
Ø 3mm



23.3256
30 cm,
Ø 6mm

**MENISCUS INSTRUMENTE
 MENISCUS INSTRUMENTS
 INSTRUMENTS A MENISQUE
 INSTRUMENTOS PARA MENISCOS
 STRUMENTI PER MENISCO**

Kniehaken, Spinalhaken
 Knee Retractors, Spinal Retractors
 Ecarteurs pour genou, Ecarteurs spinaux
 Separadores para rodilla, Separadores espinales
 Divaricatori per ginocchio, Divaricatori spinali



SMILLIE
 14 cm

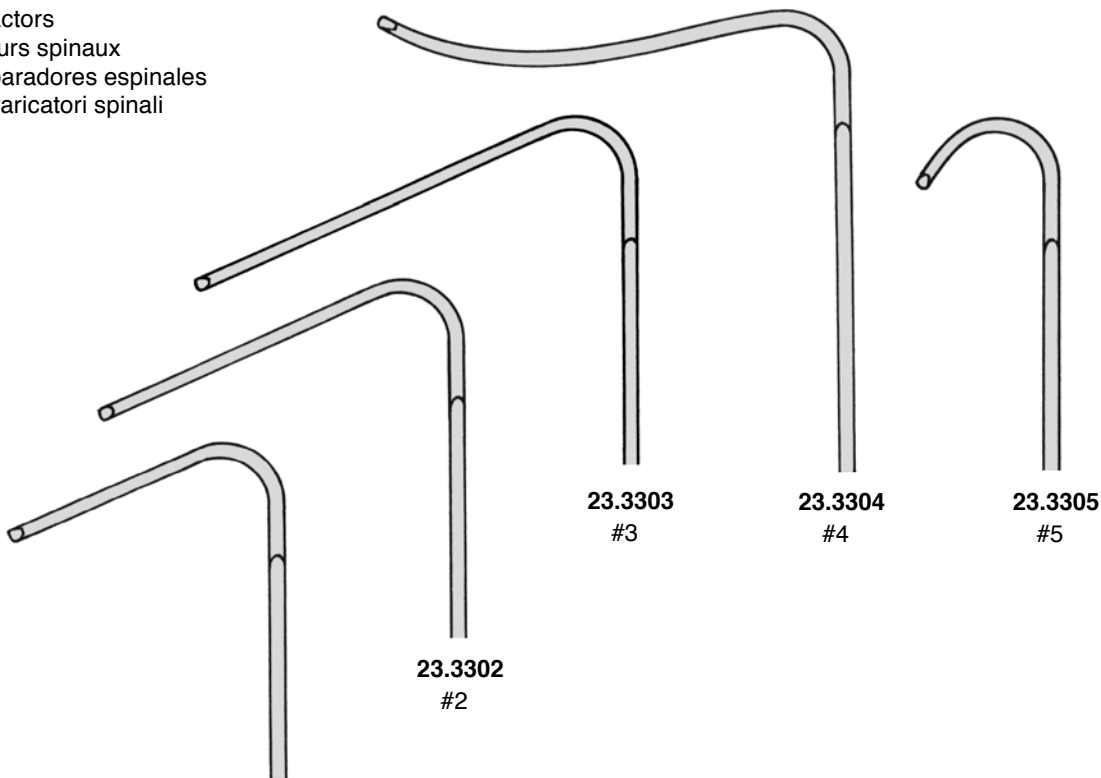

23.3301
 #1

23.3302
 #2

23.3303
 #3

23.3304
 #4

23.3305
 #5



BLOUNT
23.3310 18 cm



38 x 9 mm

23.3312
 21 cm

Knorpelscheren
Cartilage Scissors
Ciseaux pour cartilage
Tijeras para cartilago
Forbici per cartilagini

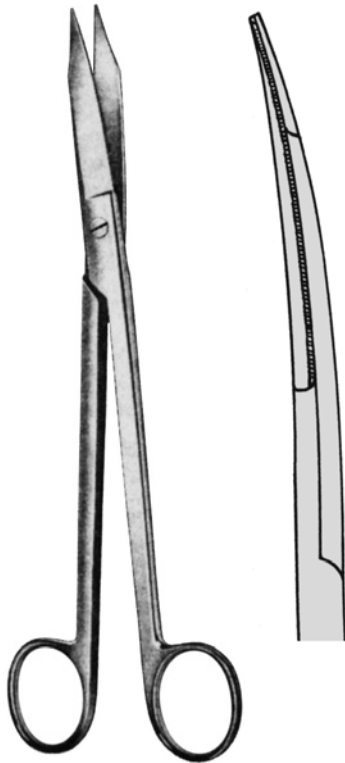

MARTIN
23.3320 20 cm

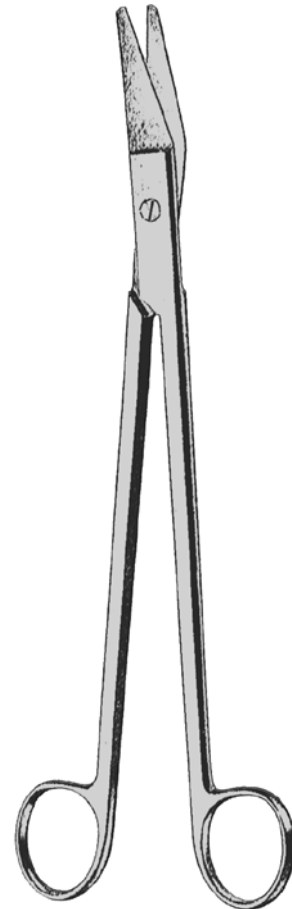

RESANO
23.3325 25 cm

Meniskus- und Knorpelfaßzange
Meniscus- and Cartilage Seizing Forceps
Pince à ménisque et à cartilage
Pinze para menisco y cartilago
Pinza per allacciare menisco e cartilagine



MARTIN
23.3354 20 cm

MENISKUS INSTRUMENTE
MENISCUS INSTRUMENTS
INSTRUMENTS A MENISQUE
INSTRUMENTOS PARA MENISCOS
STRUMENTI PER MENISCO

Meniskus- und Knorpelfaßzangen
Meniscus- and Cartilage Seizing Forceps
Pincés à ménisque et cartilage
Pinzas para menisco y cartilago
Pinze per allacciare menisco e cartilagine

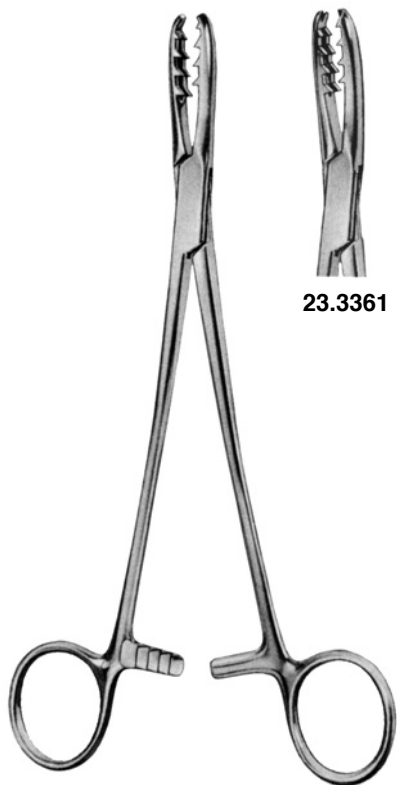

BIRCHER-GANSKE
23.3360 20 cm



BIRCHER-GANSKE
23.3363 20 cm

Patellazange
Patella Forceps
Pince patellaire
Pinza para patella
Pinze per patella



PATELLA
23.3370 18,5 cm



LOWE-BRECK
 23.3380 25 cm

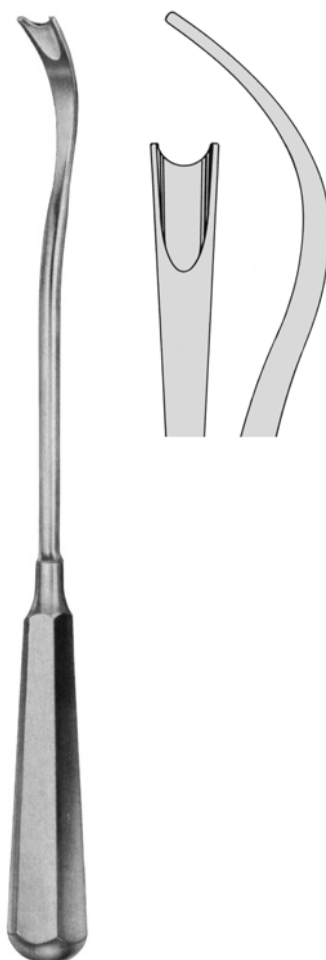

DOWNING
 23.3381 25 cm

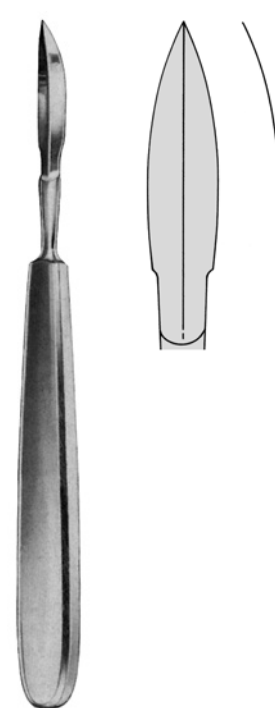

23.3383
 18 cm



SMILLIE
 17 cm



23.3396



23.3397



23.3398

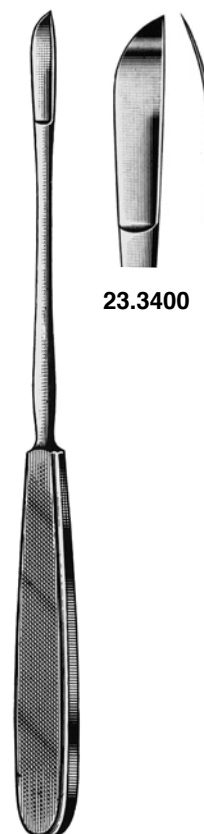

NEFF
 22 cm



23.3400



23.3402



SALENIUS
23.3410
22 cm



SALENIUS
23.3412
22 cm



BIRCHER
23.3421
20 cm

Knochendraht, in Ringen à 10 m, weich
 Bone wire, in coils of 10 mtr. (33 ft.), soft
 Fil à cerclage, souple, en rouleaux de 10 m
 Hilo para huesos, blando, en rollos de 10 m
 Filo per ossa, leggero, in bobine da m. 10



- 23.4002** 10 m / 0,2 mm
- 23.4003** 10 m / 0,3 mm
- 23.4004** 10 m / 0,4 mm
- 23.4005** 10 m / 0,5 mm
- 23.4006** 10 m / 0,6 mm
- 23.4007** 10 m / 0,7 mm
- 23.4008** 10 m / 0,8 mm
- 23.4009** 10 m / 0,9 mm
- 23.4010** 10 m / 1,0 mm
- 23.4012** 10 m / 1,2 mm
- 23.4015** 10 m / 1,5 mm
- 23.4018** 10 m / 1,8 mm
- 23.4020** 10 m / 2,0 mm



- 23.4025**
 Messlehre für Kirschnerdrähte
 Gauge for Bone Wire
 Jauge pour fils à os
 Patrón para medir hilos para huesos
 Calibro per misurare i fili per ossa

Drahtspanner
 Wire-Tighteners
 Tendeurs serre-fil
 Tensores sierra-hilo
 Strumenti tendifili

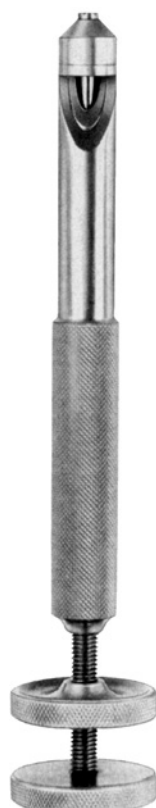

LOUTE
23.4050 21 cm

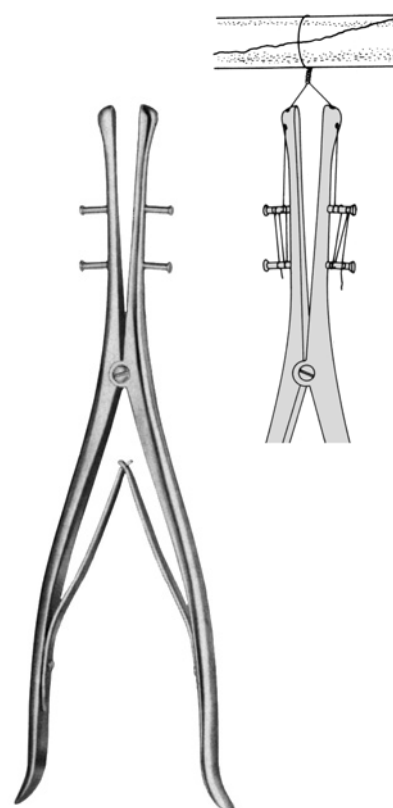

DEMEL
23.4060 28 cm

Drahtumföhrungsnadeln / Wire Guides / Aiguilles passe-fils / Agujas passa-hilos / Aghi passafili



DEMEL
28 cm

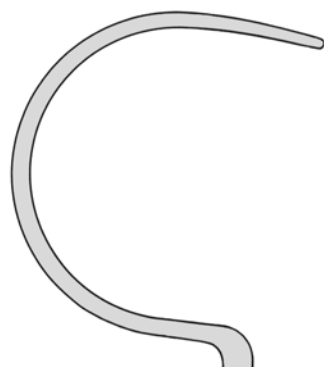

23.4070
#1

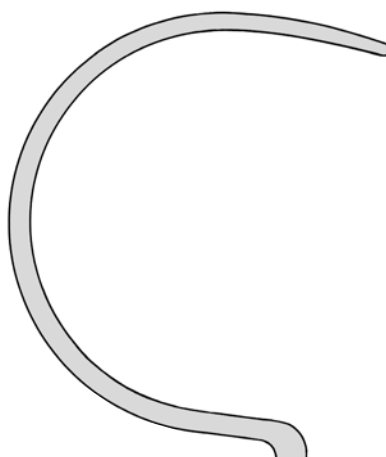

23.4072
#2

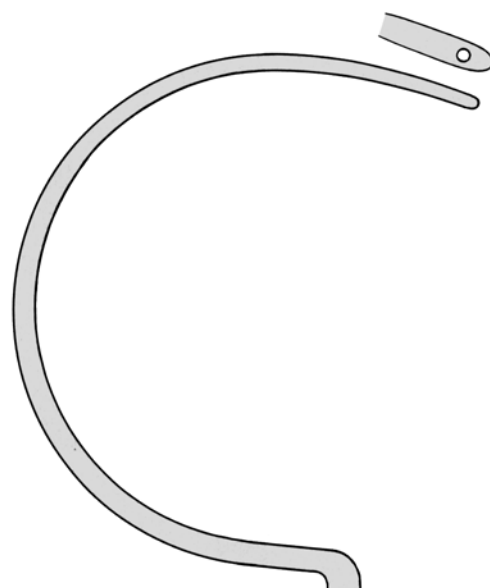

23.4074
#3



23.4080
24 cm

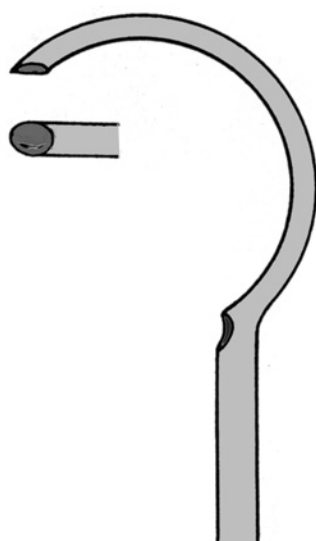

23.4082
27 cm

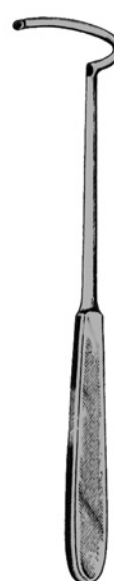
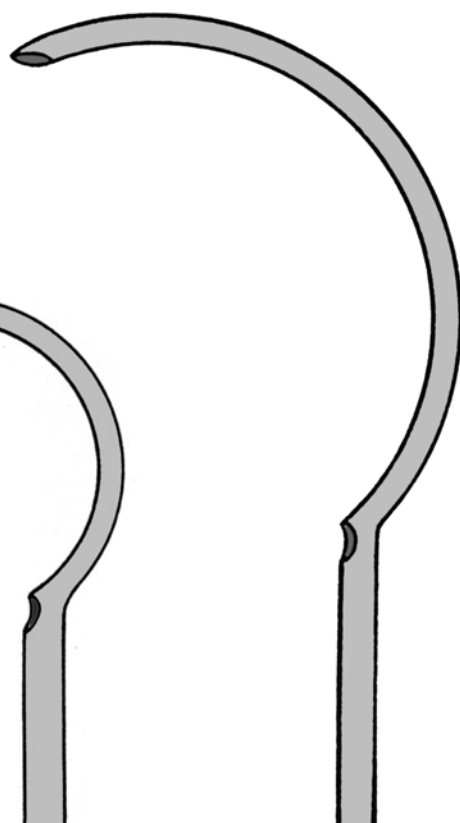

23.4085
22 cm

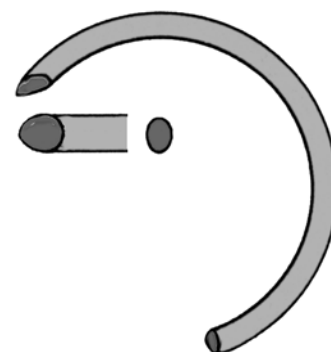



23.4130 14,5 cm



23.4135 14,5 cm



23.4180 16 cm

für harten Draht bis Ø
 hard wire up to Ø
 fils durs jusqu'à Ø
 para duros hasta Ø
 per filo duro a Ø

1,0

1,0

1,0

für weichen Draht bis Ø
 soft wire up to Ø
 fils moux jusqu'à Ø
 para blandos hasta Ø
 per filo morbido a Ø

1,5

1,5

1,5



DIAMOND
 23.4160 16 cm



23.4166 18 cm



ZIEGLER
 23.4170 18 cm

für harten Draht bis Ø
 hard wire up to Ø
 fils durs jusqu'à Ø
 para duros hasta Ø
 per filo duro a Ø

2,0

1,5

1,7

für weichen Draht bis Ø
 soft wire up to Ø
 fils moux jusqu'à Ø
 para blandos hasta Ø
 per filo morbido a Ø

2,2

2,0

2,0

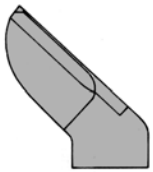

ZIEGLER
 23.4171 22 cm

1,8

2,5



HARVEY
 23.4172 23 cm

2,2

2,5



HARVEY
 23.4173 23 cm

2,2

2,5

Kopfschneider – Front Cutters – Pinces à couper frontales – Alicates de cortar frontal - Tenaglia a taglio frontale



23.4190 15 cm



DIAMOND
23.4196 21,5 cm

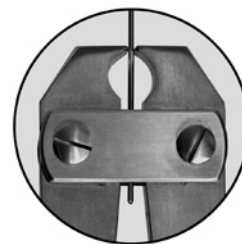

23.4270 25 cm **23.4272** 38 cm

für harten Draht bis Ø
 hard wire up to Ø
 fils durs jusqu'à Ø
 para duros hasta Ø
 per filo duro a Ø

1,5

2,5

4,0

4,5

für weichen Draht bis Ø
 soft wire up to Ø
 fils moux jusqu'à Ø
 para blandos hasta Ø
 per filo morbido a Ø

2,0

3,5



23.4290 56 cm

23.4292 45 cm

6,0

5,0

„HABILIS“ DRAHT- UND EXTRAKTIONSZANGEN
„HABILIS“ WIRE AND NAIL EXTRACTING FORCEPS
„HABILIS“ PINCES A EXTRACTION FILS ET CLOUS
„HABILIS“ PINZAS PARA EXTRAER ALAMBRES Y CLAVOS
„HABILIS“ PINZE PER ESTRAZIONE FILI E CHIODI

ca. 40 % Kraftersparnis / auswechselbare Hartmetallschneiden und Gummibacken / komplett sterilisierbar

appr. 40 % reduced effort / exchangeable TC-inserts and rubber jaws / fully sterilizable

env. 40 % moins d'effort / mors TC et mors en caoutchouc échangeables / complètement stérilisable

reducción de la fuerza manual en más de un 40% / placas TC y bocas de goma intercambiables / completamente esterilizable

meno 40% impiego di forza / lame TC e guance di goma intercambiabili / completamente sterilizabile



HABILIS
23.4100
18cm
für Rechtshänder
for right-handers
pour droitiers
para diestros
per destrimano

für Bohrdrähte bis max. Ø 2,2 mm
for drill-wires of max. Ø 2,2 mm
pour broches-filiformes jusqu'à max. Ø 2,2 mm
para taladros filiformes hasta max. Ø 2,2 mm
per perforatori filiformi a max. Ø 2,2 mm



HABILIS
23.4101
18cm
für Linkshänder
for left-handers
pour gauchers
para zurdos
per mancino



HABILIS
23.4102
23 cm

für Bohrdrähte bis max. Ø 3 mm
for drill-wires of max. Ø 3 mm
pour broches-filiformes jusqu'à max. Ø 3 mm
para taladros filiformes hasta max. Ø 3 mm
per perforatori filiformi a max. Ø 3 mm

ca. 40 % Kraftersparnis / auswechselbare Hartmetallschneiden und Gummibacken / komplett sterilisierbar

appr. 40 % reduced effort / exchangeable TC-inserts and rubber jaws / fully sterilizable

env. 40 % moins d'effort / mors TC et mors en caoutchouc échangeables / complètement stérilisable

reducción de la fuerza manual en más de un 40% / placas TC y bocas de goma intercambiables / completamente esterilizable

meno 40% impiego di forza / lame TC e guance di goma intercambiabili / completamente sterilizabile



HABILIS
23.4103
28 cm

für Bohrdrähte von Ø 2,5 bis 4,0 mm
for drill-wires of Ø 2,5 - 4,0 mm
pour broches-filiformes de Ø 2,5 - 4,0 mm
para taladros filiformes de Ø 2,5 - 4,0 mm
per perforatori filiformi da Ø 2,5 a 4,0 mm



HABILIS
23.4104
18 cm

Kopf- & Seitenschneider
Front- and Side Cutter
Pince coupe frontale et latérale
Pinza cortal frontal y lateral
Pinza con taglio frontale e laterale

für Bohrdrähte bis max. Ø 1,6 mm
for drill-wires of max. Ø 1,6 mm
pour broches-filiformes jusqu'à max. Ø 1,6 mm
para taladros filiformes hasta max. Ø 1,6 mm
per perforatori filiformi a max. Ø 1,6 mm



HABILIS
23.4105
18 cm

für orthopädische Kabel Ø 1 bis 2 mm
for orthopedic cables Ø 1 - 2 mm
pour cables orthopédiques Ø 1 - 2 mm
para cables ortopédicas Ø 1 - 2 mm
per cavi ortopedici Ø 1 - 2 mm

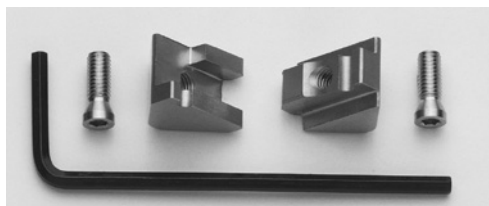

- 23.4106 für / for / pour / para / per 23.4105**
 1 Paar Schneideeinsätze, 1 Paar Schrauben, 1 Inbusschlüssel
 1 pair of TC-inserts, 1 pair of screws, 1 Allen key
 1 paire de mors TC, 1 paire de vis, 1 tournevis Allen
 1 par placas TC, 1 par de tornillos, 1 llave hexagonal
 1 paio di lami TC, 1 paio di viti, 1 chiave a brugola

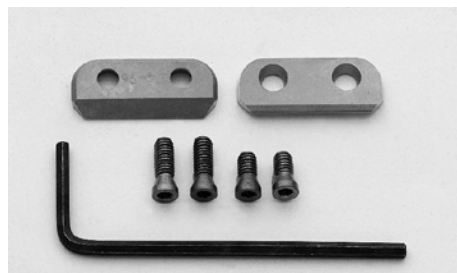

- 23.4107 für / for / pour / para / per 23.4102**
 1 Paar Schneideeinsätze, 2 Paar Schrauben, 1 Inbusschlüssel
 1 pair of TC-inserts, 2 pairs of screws, 1 Allen key
 1 paire de mors TC, 2 paires de vis, 1 tournevis Allen
 1 par placas TC, 2 pares de tornillos, 1 llave hexagonal
 1 paio di lami TC, 2 paia di viti, 1 chiave a brugola



- 23.4108 für / for / pour / para / per 23.4100, 23.4101, 23.4102, 23.4103**
 1 Paar Gummibacken, 1 Paar Schrauben
 1 pair of rubber jaws, 1 pair of screws
 1 paire de mors en caoutchouc, 1 paire de vis
 1 par de bocas di goma, 1 par de tornillos
 1 paio di guance di gomma, 1 paio di viti

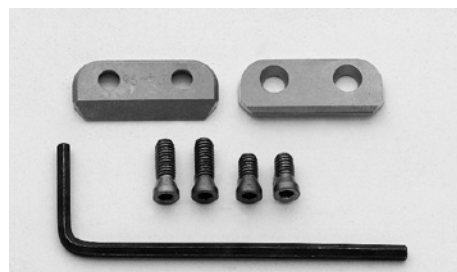

- 23.4109 für / for / pour / para / per 23.4103**
 1 Paar Schneideeinsätze, 2 Paar Schrauben, 1 Inbusschlüssel
 1 pair of TC-inserts, 2 pairs of screws, 1 Allen key
 1 paire de mors TC, 2 paires de vis, 1 tournevis Allen
 1 par placas TC, 2 pares de tornillos, 1 llave hexagonal
 1 paio di lami TC, 2 paia di viti, 1 chiave a brugola

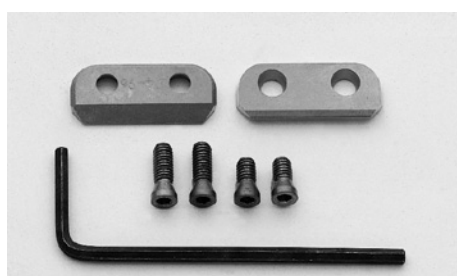

- 23.4110 für / for / pour / para / per 23.4100, 23.4101**
 1 Paar Schneideeinsätze, 2 Paar Schrauben, 1 Inbusschlüssel
 1 pair of TC-inserts, 2 pairs of screws, 1 Allen key
 1 paire de mors TC, 2 paires de vis, 1 tournevis Allen
 1 par placas TC, 2 pares de tornillos, 1 llave hexagonal
 1 paio di lami TC, 2 paia di viti, 1 chiave a brugola

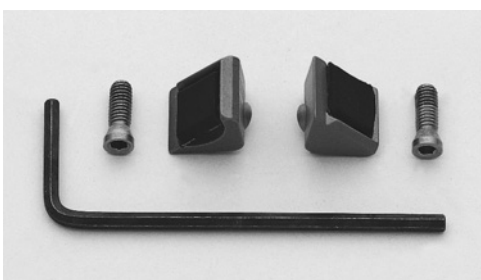

- 23.4111 für / for / pour / para / per 23.4104**
 1 Paar Schneideeinsätze mit Gummibacken, 1 Paar Schrauben,
 1 Inbusschlüssel
 1 pair of TC-inserts with rubber jaws, 1 pair of screws,
 1 Allen key
 1 paire de mors avec mors en caoutchouc, 1 paire de vis,
 1 tournevis Allen
 1 par placas TC con bocas di goma, 1 par de tornillos,
 1 llave hexagonal
 1 paio di lami TC con guance di gomma, 1 paio di viti,
 1 chiave a brugola

ca. 40 % Kraftersparnis / auswechselbare Hartmetallschneiden und Gummibacken / komplett sterilisierbar

appr. 40 % reduced effort / exchangeable TC-inserts and rubber jaws / fully sterilizable

env. 40 % moins d'effort / mors TC et mors en caoutchouc échangeables / complètement stérilisable

reducción de la fuerza manual en más de un 40% / placas TC y bocas de goma intercambiables / completamente esterilizable

meno 40% impiego di forza / lame TC e guance di goma intercambiabili / completamente sterilizabile



HABILIS
23.4113
18 cm, 3 mm

HABILIS
23.4116
18 cm, 6 mm

DRAHTFASSZANGEN, DRAHTSPANNZANGEN
WIRE HOLDING- AND TWISTING FORCEPS
PINCES A SAISIR FILS, PINCES DE TENSION
PINZAS PARA COGER Y TENSORAR ALAMBRES
TENAGLIE PER AFFERRARE E GIRARE FILI

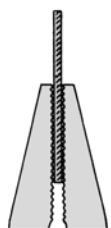

23.4205
18 cm
5 mm



23.4207
18 cm
7 mm



23.4210
18 cm



23.4213
18 cm
2,5 mm



23.4214
18 cm
3,5 mm



23.4217
18 cm
7 mm



MATHIEU
23.4218 20 cm



RUBIO
23.4219 13,0 cm
23.4219.15 15,5 cm
23.4219.17 17,5 cm
23.4219.19 19,5 cm



**DRAHTFASSZANGEN, DRAHTSPANNZANGEN
WIRE HOLDING- AND TWISTING FORCEPS
PINCES A SAISIR FILS, PINCES DE TENSION
PINZAS PARA COGER Y TENSORAR ALAMBRES
TENAGLIE PER AFFERRARE E GIRARE FILI**



MAYO-HABERISSER



23.4220 15 cm
23.4222 18 cm
23.4224 20 cm



23.4221
23.4223
23.4225



23.4231
14 cm



23.4230
17 cm



23.4232
17 cm

Drahtbiege- u. Schneidezange
Wire bending & cutting pliers
Pince à modeler et couper fils
Pinza para doblar y cortar alambre
Tenaglia per piegare & tagliare fili



23.4233
16cm



HACKSTOCK
23.4234
16 cm

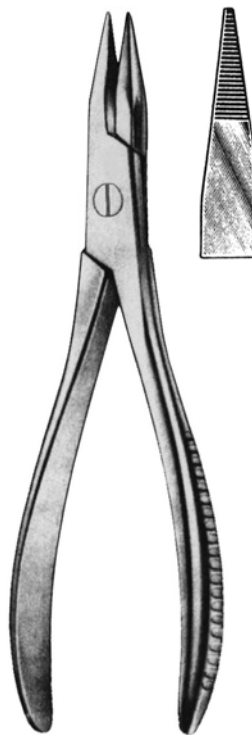
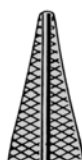

23.4235
19 cm



**DRAHTFASSZANGEN, DRAHTSPANNZANGEN
WIRE HOLDING- AND TWISTING FORCEPS
PINCES A SAISIR FILS, PINCES DE TENSION
PINZAS PARA COGER Y TENSORAR ALAMBRES
TENAGLIE PER AFFERRARE E GIRARE FILI**

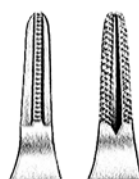

23.4236
13 cm

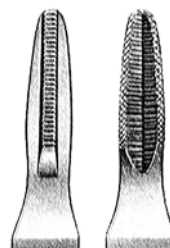

23.4238
18 cm



23.4239
17 cm

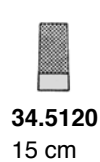
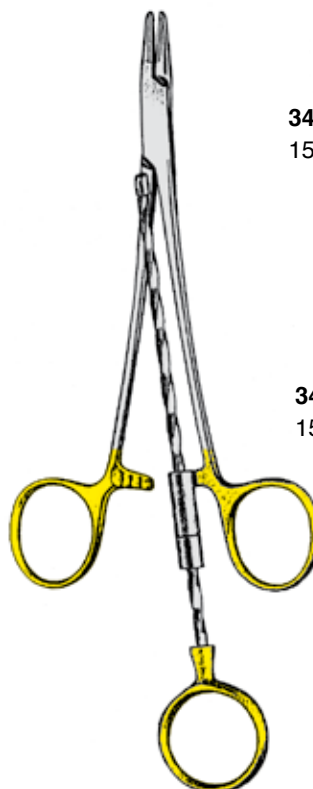

34.5120
15 cm



34.5122
15 cm



34.5124
15 cm

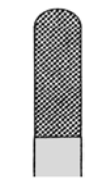

34.5126
18 cm

DRAHT- UND NAGELEXTRAKTIONSZANGEN
WIRE AND NAIL EXTRACTING FORCEPS
PINCES A EXTRACTION FILS ET CLOUS
PINZAS PARA EXTRAER ALAMBRES Y CLAVOS
PINZE PER ESTRAZIONE FILI E CHIODI



23.4253
18 cm



23.4255
18 cm

für Draht bis 1,6 mm Ø
wire up to 1,6 mm Ø
fils jusqu'à 1,6 mm Ø
para hasta 1,6 mm Ø
per fili a 1,6 mm Ø



23.4262
18 cm



23.4263
20 cm



23.4264
24 cm

DRAHT- UND NAGELEXTRAKTIONSZANGEN
WIRE AND NAIL EXTRACTING FORCEPS
PINCES A EXTRACTION FILS ET CLOUS
PINZAS PARA EXTRAER ALAMBRES Y CLAVOS
PINZE PER ESTRAZIONE FILI E CHIODI

Spitzmaulzangen
Needle-nosed pliers
Pinces à bouts pointus
Pinzas con bocas agudas
Pinze appuntate



23.4265
22 cm



23.4266
25 cm



23.4267
30 cm

siehe: Seite 150-151
 see: Page 150-151
 voir: Page 150-151
 véase: Página 150-151
 vedi: Pagina 150-151

23.

01.

15.

310

Bestellsystem
Ordering System
Système de commande
Sistema de solicitud
Sistema di ordinazione

Produktgruppe
 Product group
 Groupe de produits
 Grupo de productos
 Gruppo di prodotti

Model
 Model
 Modèle
 Modelo
 Modello

Durchmesser
 Diameter
 Diamètre
 Diamétro
 Diametro

Länge (mm)
 Length (mm)
 Longueur (mm)
 Longitud (mm)
 Lunghezza (mm)

lieferbare Durchmesser (mm):
 available diameters (mm):
 diamètres disponibles (mm):
 diámetros disponibles (mm):
 diametri disponibili (mm):

0,6 · 0,8 · 0,9 · 1,0 ·
1,1 · 1,2 · 1,25 · 1,3 ·
1,4 · 1,5 · 1,6 · 1,7 ·
1,8 · 1,9 · 2,0 · 2,2 ·
2,4 · 2,5 · 2,8 · 3,0 ·
3,2 · 3,5 · 4,0 · 4,5 ·
4,8 · 5,0 · 5,5 · 6,0

lieferbare Längen (mm):
 available lengths (mm):
 longueurs disponibles (mm):
 longitudes disponibles (mm):
 lunghezze disponibili (mm):























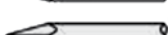

















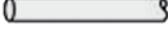
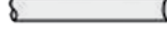



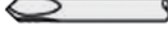
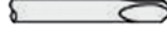

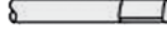

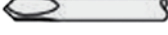





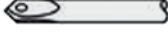



50 - 600

Verpackungseinheit = 10 Stück
 Packing unit = 10 pcs.
 Emballage: 10 pièces
 Unidad de 10 piezas
 Confezione da 10 pezzi

Preise: auf Anfrage
 Prices: on application
 Prix: sur demande
 Precios: por demande
 Prezzi: su richiesta

Verpackung:
 Packaging:
 Emballage:
 Embalaje:
 imballaggio:



Model Modell Modèle Modelo Modello		Deutsch	English
	01 	Trokar-flach	trocar-flat
	02 	Trokar-rund	trocar-round
	03 	Trokar-Trokar	trocar-trocar
	04  	Trokar-3Kant	trocar-triangular
	05  	Trokar-4Kant	trocar-square
	06 	Trokar-flach mit Loch	trocar-flat with eye
	12 	Trokar mit 15mm Gewindeansatz-flach	trocar with 15mm thread-flat
	13 	Trokar mit 15mm Gewindeansatz-rund	trocar with 15mm thread-round
	14 	Trokar-Trokar mit je 15mm Gewindeansatz	trocar-trocar with 15mm thread on each end
	15  	Trokar mit 15mm Gewindeansatz-3Kant	trocar with 15mm thread-triangular
	17 	Trokar-flach mit ganzem Gewinde	trocar-flat with full thread
	18 	Trokar-rund mit ganzem Gewinde	trocar-round with full thread
	19 	Trokar-Trokar mit ganzem Gewinde	trocar-trocar with full thread
	25 	rund-rund "Hackethal"	round-round "Hackethal"
	31 	Lanzette-flach	lancet-flat
	32 	Lanzette-rund	lancet-round
	33 	Lanzette-Lanzette	lancet-lancet
	34  	Lanzette-3Kant	lancet-triangular
	35  	Lanzette-4Kant	lancet-square
	36 	Lanzette-flach mit Loch	lancet-flat with eye
	37 	Lanzette mit Loch-rund	lancet with eye-round
	38 	Lanzette-Lanzette mit je 1 Loch	lancet-lancet with eye on each side
	39 	Lanzette mit Loch-Trokar	lancet with eye-trocar
	40 	Lanzette-Trokar	lancet-trocar
	42 	Lanzette-Lanzette mit je 15mm Gewindeansatz	lancet-lancet with 15mm thread on each end
	44 	Trokar längsgerändelt-rund	trocar w. longitudinal serration-round
	45 	Trokar längsgerändelt-Spezialöse	trocar w. longitudinal serration-special eye
	46 	Bohransatz-rund	drilltip-round
	47 	Bohransatz-Spezialöse	drilltip-special eye

Français	Español	Italiano
trocart-plat	trocar-plano	trequarti-piatto
trocart-rond	trocar-redondo	trequarti-tondo
trocart-trocart	trocar-trocar	trequarti-trequarti
trocart-triangulaire	trocar-triangular	trequarti-triangolo
trocart-carré	trocar-quadrado	trequarti-quadrato
trocart-plat, perforée	trocar-plano con ojo	trequarti-piatto con buco
trocart avec 15mm filetage-plat	trocar con rosca 15mm-plano	trequarti con filetto 15mm - piatto
trocart avec 15mm filetage-rond	trocar con rosca 15mm-redondo	trequarti con filetto 15mm-tondo
trocart-trocart avec 15mm filetage de chaque côté	trocar-trocar con rosca 15mm en cada parte	trequarti-trequarti con filetto 15mm entrambe le parti
trocart avec 15mm filetage-triangulaire	trocar con rosca 15mm-triangular	trequarti con filetto 15mm - triangolo
trocart-plat complètement fileté	trocar-plano con rosca completo	trequarti-piatto con filetto completo
trocart-rond complètement fileté	trocar-redondo con rosca completo	trequarti-tondo con filetto completo
trocart-trocart complètement fileté	trocar-trocar con rosca completo	trequarti-trequarti con filetto completo
rond-rond "Hackethal"	redondo-redondo "Hackethal"	tondo-tondo "Hackethal"
lancette-plat	lanceolar-plano	lanceolato-piatto
lancette-rond	lanceolar-redondo	lanceolato-tondo
lancette-lancette	lanceolar-lanceolar	lanceolato-lanceolato
lancette-triangulaire	lanceolar-triangular	lanceolato-triangolo
lancette-carré	lanceolar-quadrado	lanceolato-quadrato
lancette-plat, perforée	lanceolar-plano con ojo	lanceolato-piatto con buco
lancette perforée-rond	lanceolar con ojo-redondo	lanceolato con buco-tondo
lancette-lancette perforée à chaque côté	lanceolar-lanceolar con ojo en cada parte	lancelato-lancelato con buco entrambe le parti
lancette perforée-trocart	lanceolar con ojo-trocar	lancelato con buco-trequarti
lancette-trocart	lanceolar-trocar	lancelato-trequarti
lancette-lancette avec 15mm filetage de chaque côté	lanceolar-lanceolar con rosca 15mm en cada parte	lancelato-lancelato con filetto 15mm entrambe le parti
trocart rainuré long-rond	trocar moleteado a lo largo-redondo	trequarti longitudinalmente scannellato-tondo
trocart rainuré long-oillet special	trocar moleteado-ojete especial	trequarti longitudinalmente scannellato-occhiello speciale
point foret-rond	perforador-redondo	trepano-tondo
point foret-oillet special	perforador-ojete especial	trepano-occhiello speciale

KIRSCHNER BOHRDRÄHTE
KIRSCHNER WIRES
KIRSCHNER BROCHES
KIRSCHNER BROCAS
KIRSCHNER FILI PERFORATORI



	mm Ø	L = 6 cm	L = 12 cm	L = 14 cm	L = 16 cm	L = 31 cm
Trokarspitze	0,6	23.4446				
Trocar tip	0,8	23.4448	23.4468	23.4488	23.4508	23.4538
Pointe trocart	0,9	23.4449	23.4469	23.4489	23.4509	23.4539
Punta en forma de trócar	1,0	23.4450	23.4470	23.4490	23.4510	23.4540
punta trequarti	1,1	23.4451	23.4471	23.4491	23.4511	23.4541
	1,2	23.4452	23.4472	23.4492	23.4512	23.4542
	1,3	23.4453	23.4473	23.4493	23.4513	23.4543
	1,4	23.4454	23.4474	23.4494	23.4514	23.4544
	1,5	23.4455	23.4475	23.4495	23.4515	23.4545
	1,6	23.4456	23.4476	23.4496	23.4516	23.4546
	1,7	23.4457	23.4477	23.4497	23.4517	23.4547
	1,8	23.4458	23.4478	23.4498	23.4518	23.4548
	1,9	23.4459	23.4479	23.4499	23.4519	23.4549
	2,0	23.4460	23.4480	23.4500	23.4520	23.4550
	2,2	23.4462	23.4482	23.4502	23.4522	23.4552
	2,5	23.4465	23.4485	23.4505	23.4525	23.4555

KIRSCHNER



	mm Ø	L = 31 cm
Lanzenspitze	0,9	23.4569
Lancet tip	1,0	23.4570
Pointe lancéolaire	1,1	23.4571
Punta lanceolar	1,2	23.4572
punta lanceolato	1,3	23.4573
	1,4	23.4574
	1,5	23.4575
	1,6	23.4576
	1,7	23.4577
	1,8	23.4578
	1,9	23.4579
	2,0	23.4580
	2,2	23.4582
	2,5	23.4585

KIRSCHNER

Verpackungseinheit = 10 Stück

Packing unit = 10 pcs.

Emballage: 10 pièces

Unidad de 10 piezas

Confezione da 10 pezzi



STEINMANN Nägel
 STEINMANN pins
 STEINMANN clous à os
 STEINMANN chiodi per ossa
 Chiodi STEINMANN

L = cm	
8	24.2840
10	24.2841
12	24.2842
14	24.2843
15	24.2844
16	24.2845
18	24.2846
20	24.2847
21	24.2848

STEINMANN
 Ø 4 mm

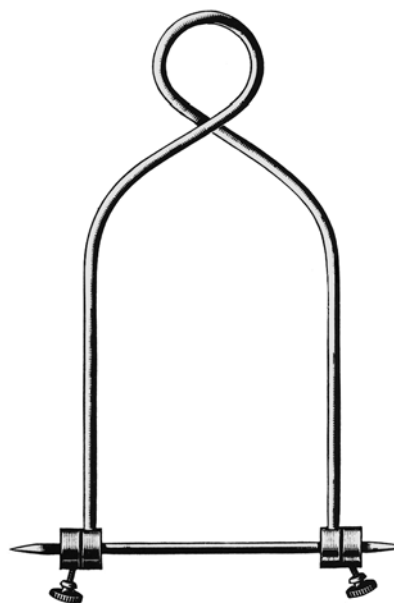

BOEHLER

24.2959 90 x 75 mm

24.2960 160 x 90 mm

24.2962 210 x 110 mm

24.2964 210 x 150 mm

Extensionsbügel zur Verwendung mit STEINMANN Nägeln

Traction bows for use with STEINMANN pins

Etriers de traction à utiliser avec clous de STEINMANN

Estribos para extensión para clavos de STEINMANN

Archi per estensione da impiegarsi utilizzabili con chiodi STEINMANN



23.4400
für Drähte bis / for wires up to / pour broches jusqu'à /
para brocas hasta / per fili a 10 cm

23.4401
für Drähte bis / for wires up to / pour broches jusqu'à /
para brocas hasta / per fili a 15 cm



23.4402
für Drähte bis / for wires up to / pour broches jusqu'à /
para brocas hasta / per fili a 22 cm

23.4403
für Drähte bis / for wires up to / pour broches jusqu'à /
para brocas hasta / per fili a 28 cm

23.4404
für Drähte bis / for wires up to / pour broches jusqu'à /
para brocas hasta / per fili a 31 cm



23.4433
33 cm
L 31 cm — Ø 3,0mm



23.4426
18,5 cm
L 16 cm — Ø 3,0mm



23.4422
13 cm
L 12 cm — Ø 3,0mm

**BOHRDRAHTSPENDER
DRILL WIRE DISPENSERS
DISTRIBUTEURS DE BROCHES FILIFORMES
DISPENSADORES PARA BROCAS FILIFORMES
DISTRIBUTORI PER FILI DIFFERENTI**

Mehrfach-Bohrdrahtspender
Multiple Wire Drill Dispensers
Distributeurs de broches filiformes différentes
Dispensadores de brocas filiformes diferentes
Distributori per fili differenti



VICKERS
23.4410
12 cm
Ø 1,0 / 1,2 / 1,4 / 1,6mm →
L 100 mm



VICKERS
23.4412
16 cm
Ø 1,0 / 1,2 / 1,4 / 1,6mm →
L 150 mm
23.4414
16 cm
Ø 1,8 / 2,0 / 2,2 / 2,5mm →
L 150 mm



VICKERS
23.4416
34 cm
Ø 1,0 / 1,2 / 1,4 / 1,6mm →
L 310 mm
23.4418
34 cm
Ø 1,8 / 2,0 / 2,2 / 2,5mm →
L 310 mm



23.4590
Biegeinstrument für Bohrdrähte → Ø 2,7 mm
Bending iron for K-wires → Ø 2,7 mm
Tord-broches 12cm pour broches → Ø 2,7 mm
Instrumento para doblar brocas → Ø 2,7 mm
Strumento per piegare fili fino a → Ø 2,7mm

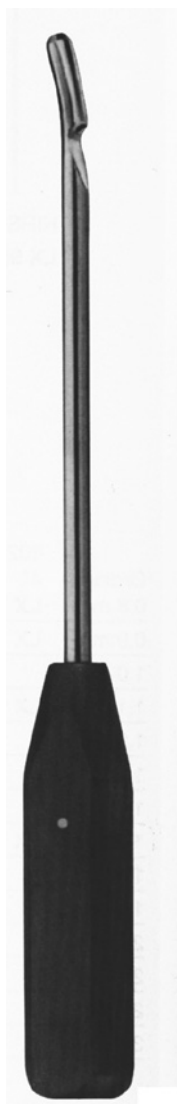

WAGNER
23.4593
30 cm
Biegeinstrument f. Bohrdrähte bis → Ø 3,0mm
Bending Iron 30cm for K-wires → Ø 3,0mm
Plieur 30 cm pour broches filiformes → Ø 3,0mm
Plegador 30cm para brocas filiformes → Ø 3,0mm
Piegatore 30cm per perforatori filiformi → Ø 3,0mm

Extensionsbügel mit 3 Zughaken
Traction bows with 3 traction hooks
Etriers à extension avec 3 crochets de traction
Estribos para extensión con 3 ganchos de tracción
Archi per estensione con 3 ganci di trazione

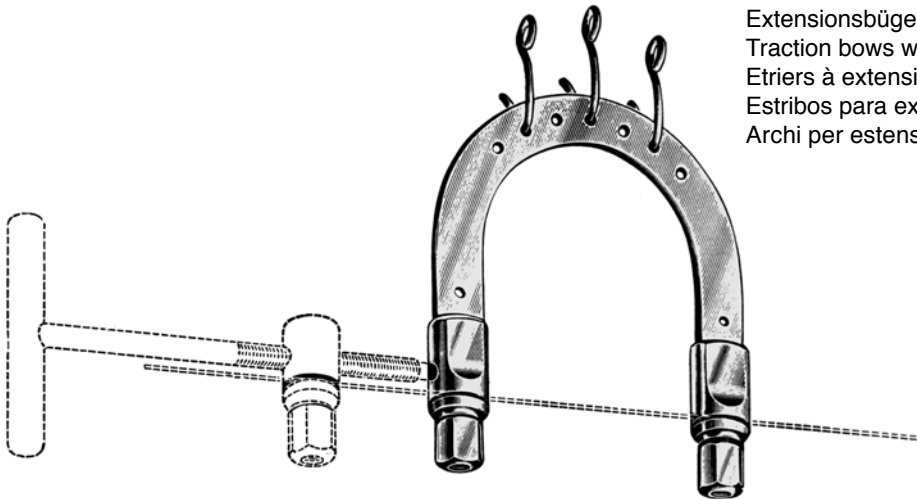

- KIRSCHNER**
23.4600 200 x 155 mm
23.4601 155 x 155 mm
23.4602 135 x 130 mm
23.4603 120 x 120 mm
23.4604 105 x 105 mm
23.4605 95 x 110 mm
23.4606 95 x 70 mm

- KIRSCHNER**
23.4607 60 x 50 mm

Fixierscheiben (Paar)
Fixation discs (pair)
Disques à fixation paire
Discos fijadores (par)
Dischi di fissaggio (paio)

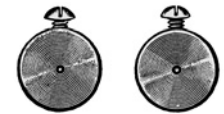

- KIRSCHNER**
23.4617

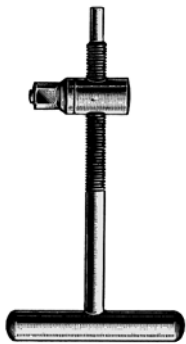

- KIRSCHNER**
23.4608

Spannschlüssel für Bohrdrähte
Wire tightener
Tendeur de broches
Tensor de taladros filiformes
Chiave tenditrice per perforatori filiformi



- KIRSCHNER**
23.4609
 Spannschlüssel
Wrench
Clef plate
Llave de tuercas
Chiave per madreviti



- 23.4610** 180 x 100 mm
23.4611 270 x 160 mm



- KIRSCHNER**
23.4614



- KIRSCHNER**
23.4615
 Zughaken
Traction hooks
Crochet de traction
Ganchos de tracción
Ganci di trazione

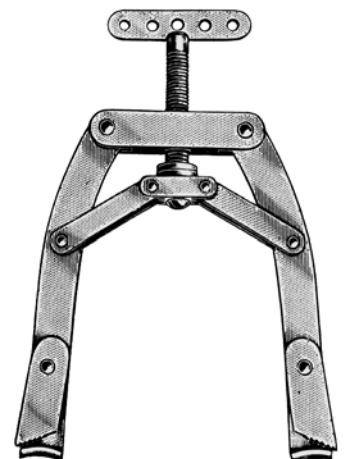

- KIRSCHNER**
23.4618 max. Öffnung
max. jaw opening
ouverture max.
apertura max.
apertura massima
130 mm
23.4619 US-Mod. klein
185 mm
23.4620 US-Mod. gross
220 mm
 US-Mod. X-Gross

**HANDBOHRAPPARATE
HAND DRILLS
PERFORATEURS A MAIN
PERFORADORES DE MANO
PERFORATORI A MANO**

teleskopische Bohrdrabtstütze
telescopic Wire Drillguide
Guide télescopique de broches
Conductor telescópico p. taladros filiformes
Conduttore telescopico per taladri filiformi

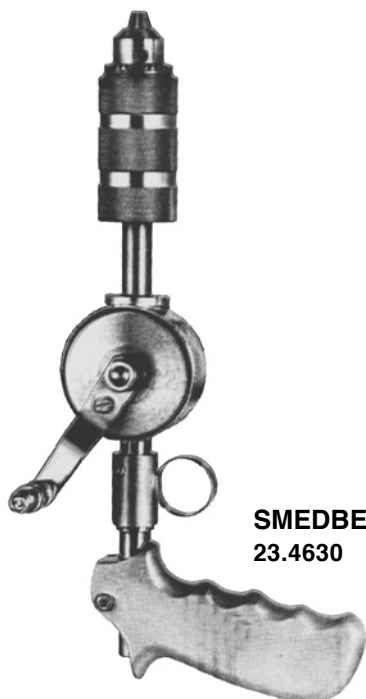

**SMEDBERG
23.4630**



**KIRSCHNER
23.4650**



23.4651



**KIRSCHNER
23.4660**

23.4661



**STILLE
23.4670**



**STILLE-SHERMAN
23.4675**



MOORE
23.4680

komplett mit einem Satz Bohrer Nr. 23.4685
complete with set of twist drills No. 23.4685
complet avec 1 jeu de mèches No. 23.4685
completo con juego de taladros No. 23.4686
completo con una serie di trepani No. 23.4685



MOORE
23.4685

Bohrer 2x70x3,2 mm, 1 x 90x3,2 mm
Twist Drills 2x70x3,2 mm, 1 x 90x3,2 mm
Mèches 2x70x3,2 mm, 1 x 90x3,2 mm
Taladros 2x70x3,2 mm, 1 x 90x3,2 mm
Trepani 2x70x3,2 mm, 1 x 90x3,2 mm

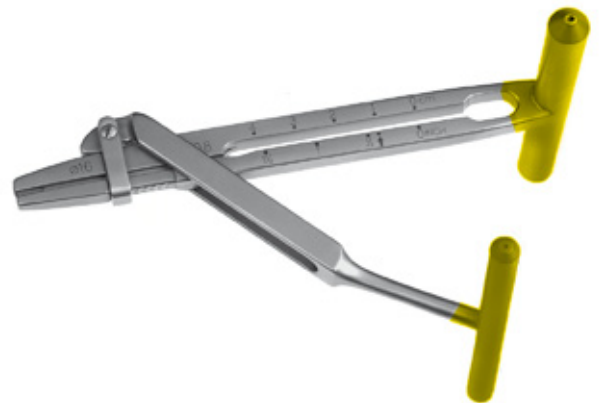

VICKERS-Easydriver
23.4704

14 cm

Bohrhandgriffe mit Dreibackenspannfutter
Handles with chuck
Manches avec mandrin
Mangos con mandrin
Trepani a mano con mandrino

Bohrhandgriffe mit Dreibackenspannfutter
Handles with chuck
Manches avec mandrin
Mangos con mandrin
Trepani a mano con mandrino

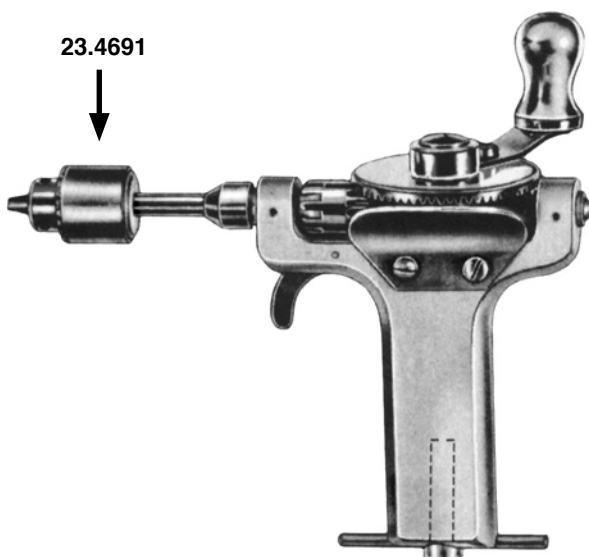

BUNNELL
23.4690

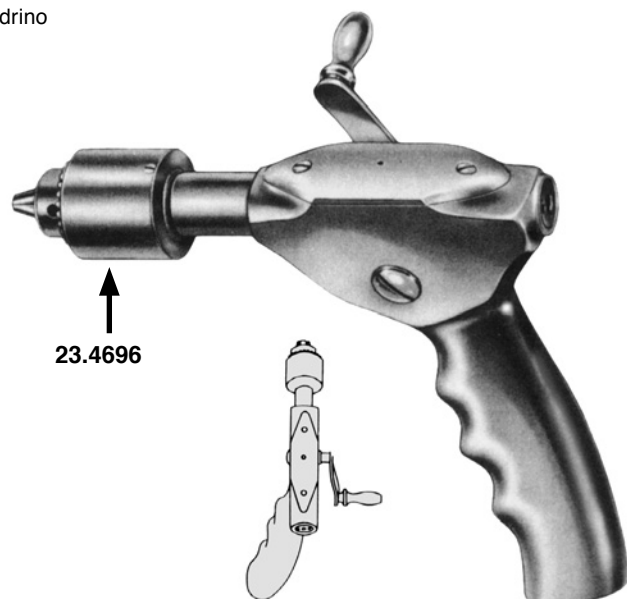

RALK
23.4695

HANDBOHRAPPARATE
HAND DRILLS
PERFORATEURS A MAIN
PERFORADORES DE MANO
PERFORATORI A MANO

Bohrhandgriffe mit Dreibackenspannfutter
Handles with chuck
Manches avec mandrin
Mangos con mandrin
Trepani a mano con mandrino



23.4697 14 cm

längsdurchbohrt bis Ø 3,95 mm
longitudinally bored up to Ø 3,95 mm
à perforation axiale jusqu'à Ø 3,95 mm
taladrado longitudinalmente hasta Ø 3,95 mm
forato longitudinalmente a Ø 3,95 mm

23.4699

Spannschlüssel
Key
Clé
Llave
Chiave per mandrino



23.4700 12 cm

längsdurchbohrt bis Ø 6,35 mm
longitudinally bored up to Ø 6,35 mm
à perforation axiale jusqu'à Ø 6,35 mm
taladrado longitudinalmente hasta Ø 6,35 mm
forato longitudinalmente a Ø 6,35 mm

23.4701

Spannschlüssel
Key
Clé
Llave
Chiave per mandrino



23.4702 16 cm

längsdurchbohrt bis Ø 6,35 mm
longitudinally bored up to Ø 6,35 mm
à perforation axiale jusqu'à Ø 6,35 mm
taladrado longitudinalmente hasta Ø 6,35 mm
forato longitudinalmente a Ø 6,35 mm

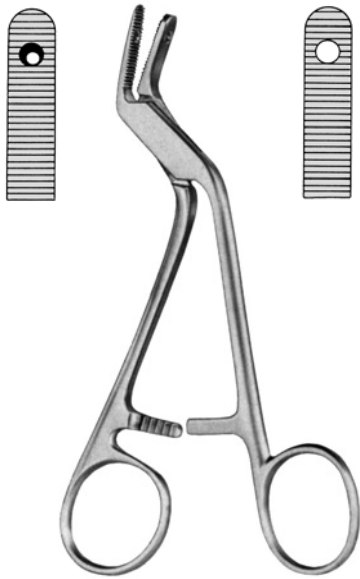

ADSON
 23.4990 15 cm

Bohrerführungs- und Gewebe-Schutzzange
 Drill guide and protecting forceps
 Pince-guide mèche et protège mère
 Pinza-guia para taladros y para proteger la madre
 Pinza guida sonda e per la protezione della madre



23.4996 14 cm

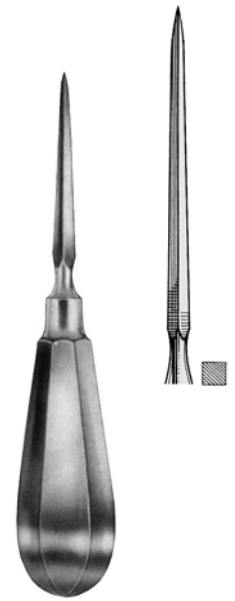

23.4997 14 cm



PERTHES
 23.4995 18 cm



PERTHES
 23.4998 21,5 cm

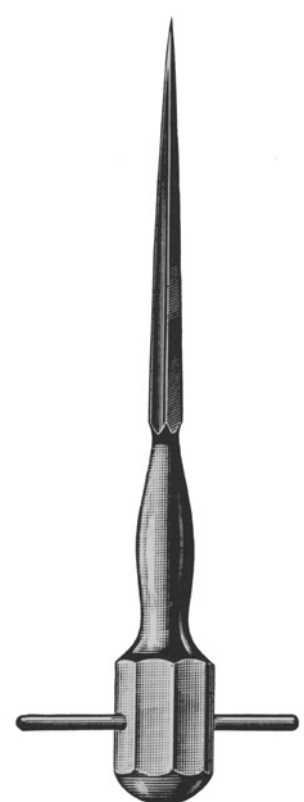

PERTHES
 23.4999 21 cm

