

TUCH- UND SCHLAUCHKLEMMEN,
TUPFERZANGEN

TOWEL- AND TUBING CLAMPS,
DRESSING- AND SPONGE FORCEPS

PINCES A CHAMPS ET A TAMPONS,
PINCES PRESSE-TUBES

PINZAS DE CAMPO, PARA TUBOS
Y PARA TAMPONES

PINZE FISSATELI, PINZE SERRATUBI
PINZE PER TAMPONI





JONES
16.0010 5 cm
16.0012 9 cm



SCHAEDEL
16.0031 9 cm

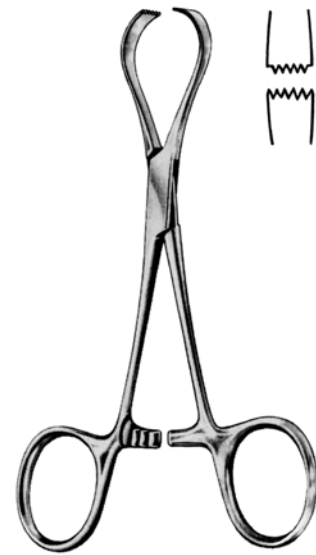

OMBREDANNE (Jackson)
16.0150 13,5 cm

mit Schlauchhalter
with tubeholder
avec clamp porte-tube
con porta-tubo
con porta-tubo

für Papiertücher
for paper drapes
pour champs en papier
para paños de papel
per fazzoletti di carta



BACKHAUS
16.0100 9 cm
16.0102 11cm
16.0105 13 cm
16.0106 15 cm



BACKHAUS
16.0107 11 cm
16.0108 13 cm

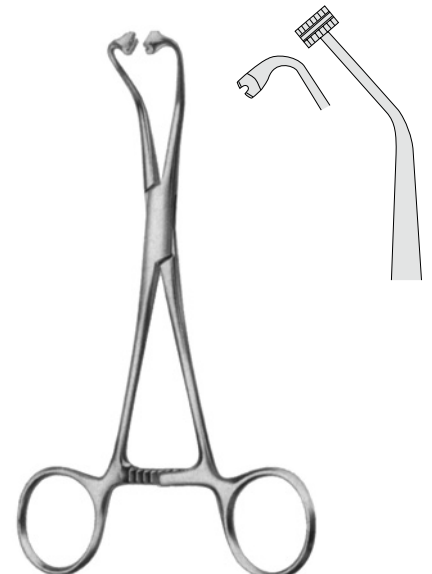

PEERS
16.0112 14,5 cm

für Papierabdeckung / for paper drapes / pour couverture en papier / para paños de papel / per copertura di carta



ROEDER

16.0115 13 cm
16.0116 15 cm

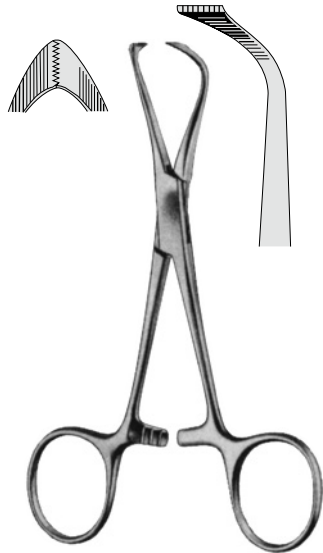

LORNA

16.0120 10 cm
16.0125 13 cm



BALL&SOCKET

16.0132 11 cm
16.0135 13 cm

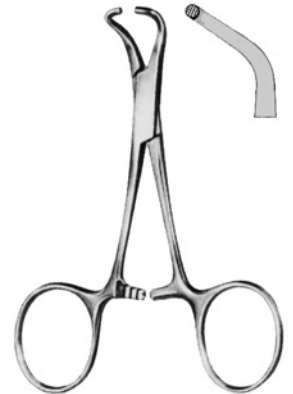

TOHOKU

16.0140 10 cm
16.0145 13 cm

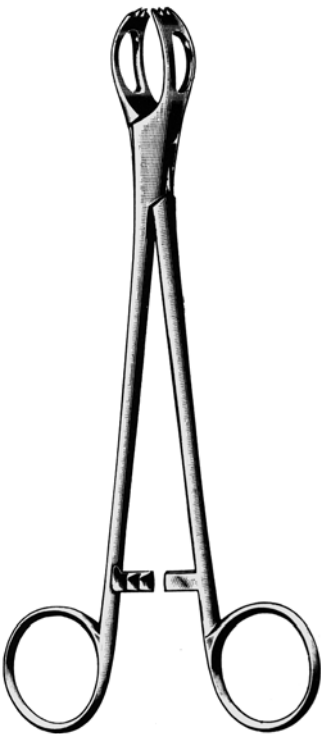

LANE

16.0160 15 cm
16.0164 20 cm



BERNHARD

16.0170 16,5 cm



MOYNIHAN

16.0180 19 cm

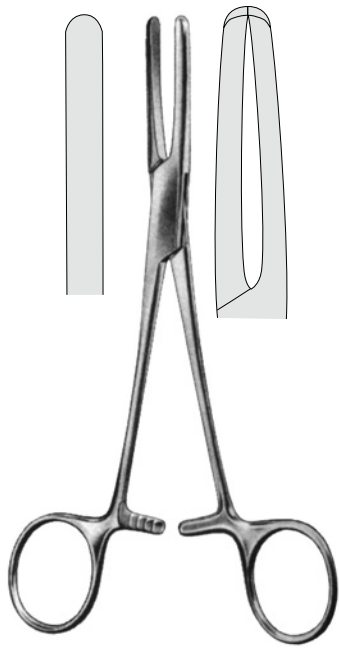

PRESBYTERIAN
 16.0200 16 cm
 16.0202 18 cm



KLINIK-BERLIN
 16.0210 14,5 cm

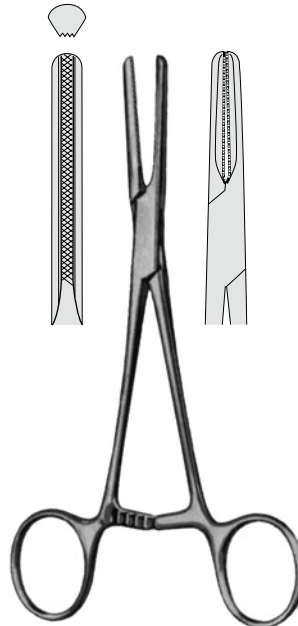

USA-MODEL
 16.0220 16 cm
 16.0222 18 cm
 16.0224 20 cm

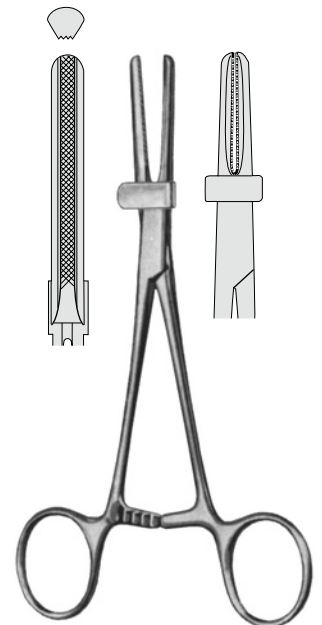

TUBING
 16.0230 16 cm
 16.0232 18 cm
 16.0234 20 cm

Schlauchroller
 Tube milking clamps
 Pincès à traire les drains
 Rodillos para tubos
 Pinze pressa tubi con rulli



BROMPTON
 16.0280 15,5 cm

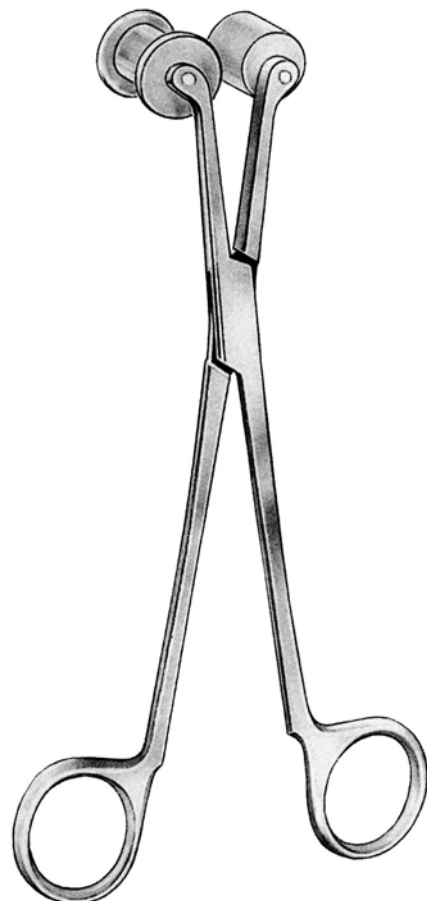

GUNNAR-HEY
 16.0290 19 cm

SCHWAMMZANGEN
 SPONGE FORCEPS
 PINCES POUR ÉPONGES
 PINZAS PARA TAMPONES
 PINZE PER TAMPONI E SPUGNE



BERGMANN-FOERSTER
 16.0390 24 cm



BERGMANN-FOERSTER
 16.0391 24 cm

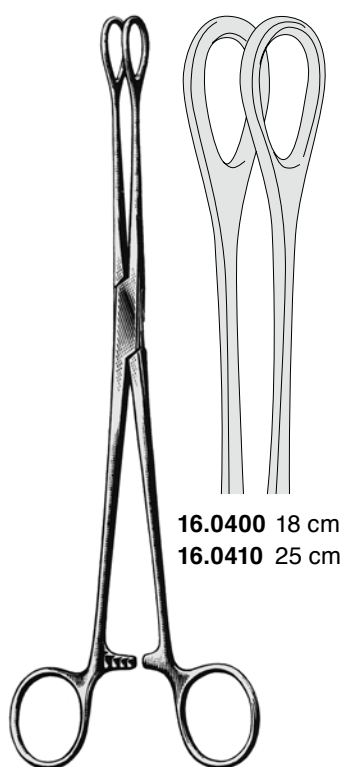

16.0400 18 cm
16.0410 25 cm

FOERSTER

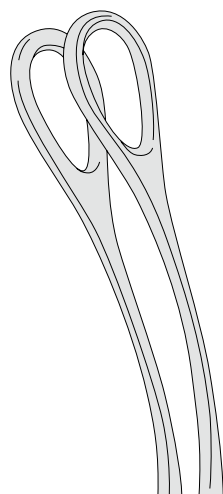

16.0401 18 cm
16.0411 25 cm

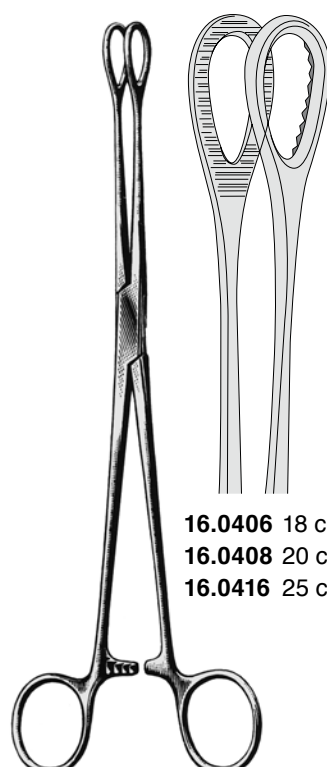

16.0406 18 cm
16.0408 20 cm
16.0416 25 cm

BALLENGER

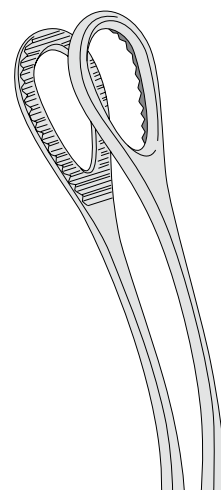

16.0407 18 cm
16.0409 20 cm
16.0417 25 cm

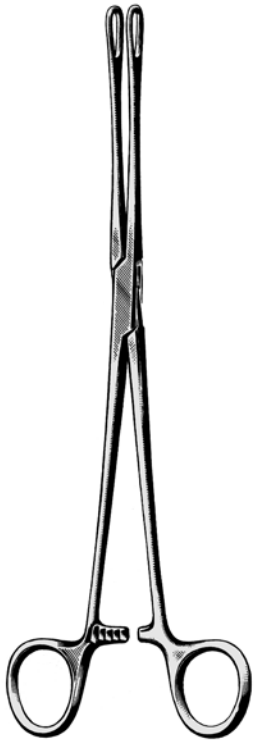

FOERSTER-DELIKAT
 25 cm

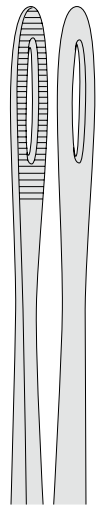

16.0418

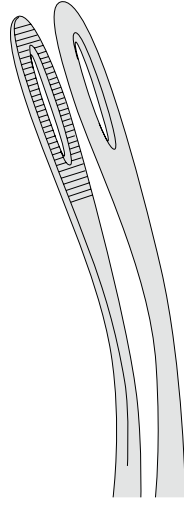

16.0419



RAMPLEY
 16.0420 25 cm

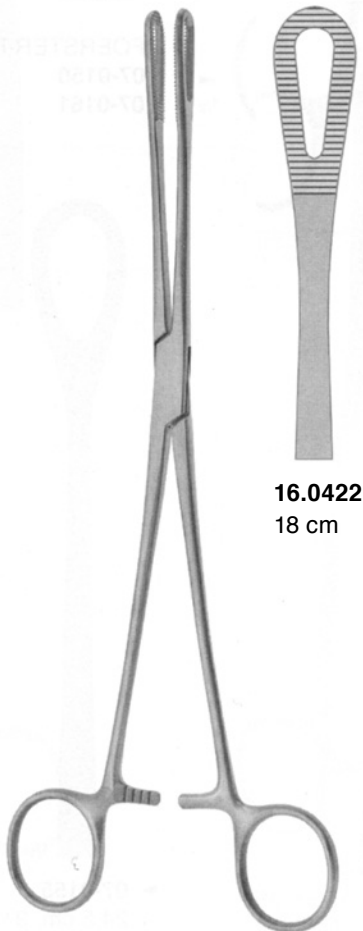

RAMPLEY



16.0422
 18 cm



16.0423
 25 cm

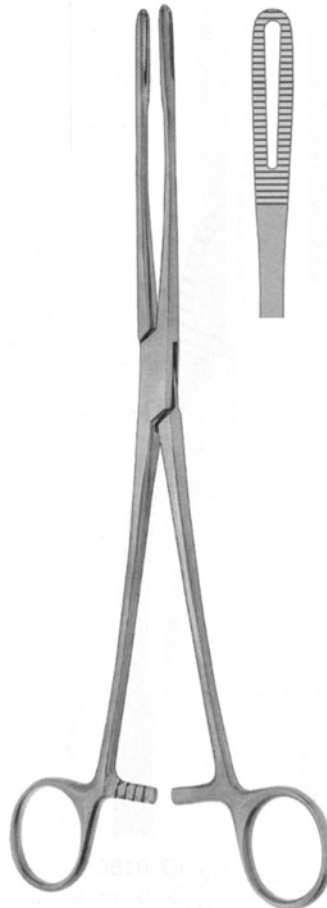

FLETCHER (Javerts)
 16.0424 24 cm



FLETCHER (Javerts)
 16.0425 24 cm

KORN- UND TUPFERZANGEN
SPONGE- AND DRESSING FORCEPS
PINCES À PANSEMENTS ET TAMPONS
PINZAS PARA VENDAJES Y TORUNDAS
PINZE PER MEDICATURAS E TAMPONI

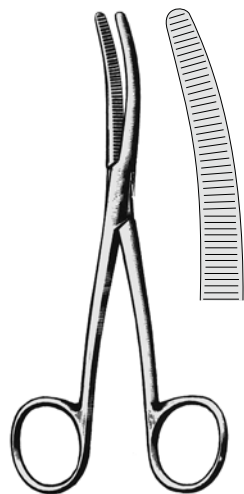

BRYANT
 16.0300 13 cm



LISTER-SINUS
 16.0360 13 cm
 16.0362 16 cm
 16.0364 18 cm



WALTON
 16.0370 17 cm



WALTON
 16.0371 17 cm



SIMS-MAIER
 16.0426 28 cm

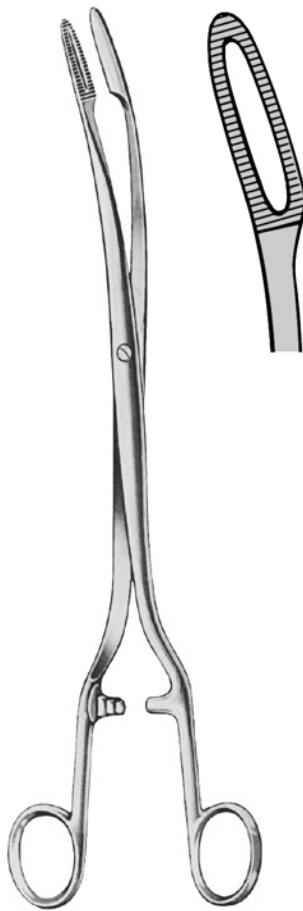

SIMS-MAIER
 16.0427 28 cm



PELKMANN
 16.0430 25 cm



PELKMANN
 16.0431 25 cm

KORN- UND TUPFERZANGEN
 SPONGE- AND DRESSING FORCEPS
 PINCES À PANSEMENTS ET TAMPONS
 PINZAS PARA VENDAJES Y TORUNDAS
 PINZE PER MEDICATURAS E TAMPONI



DUPLAY
 16.0440 20 cm

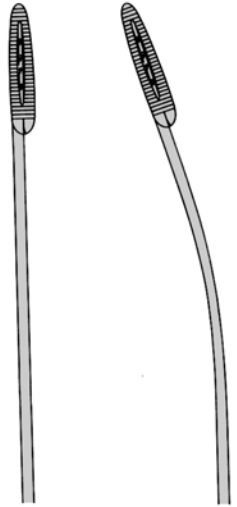

16.0441

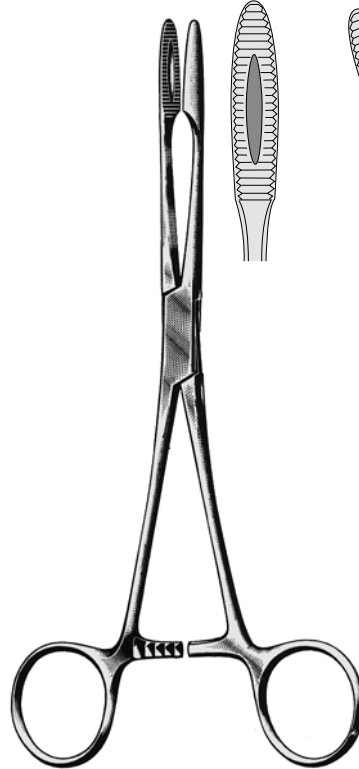

GROSS
 16.0450 20 cm
 16.0452 22 cm
 16.0454 26 cm

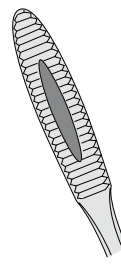

16.0451 20 cm
 16.0453 22 cm
 16.0455 26 cm

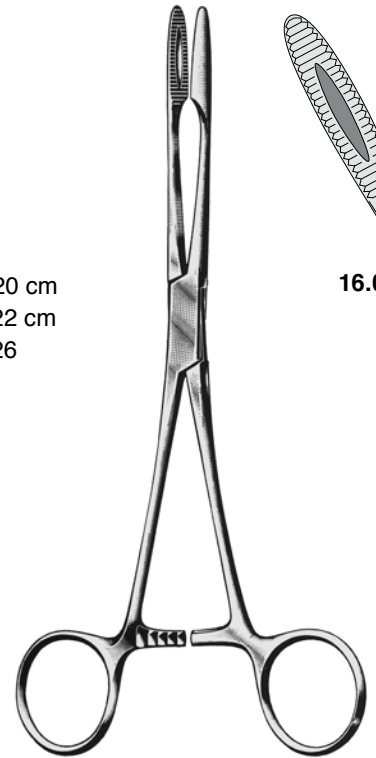

MAIER
 16.0460 25 cm

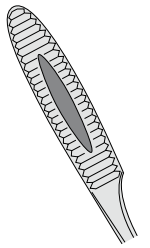

16.0461

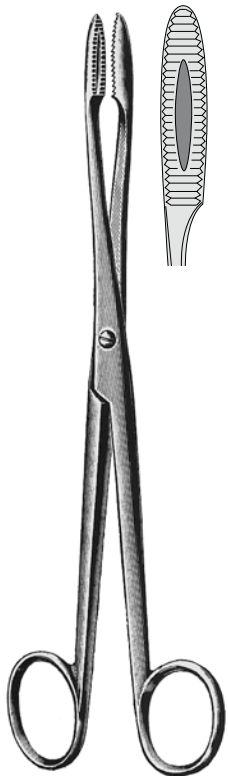

MAIER
 16.0462 25 cm

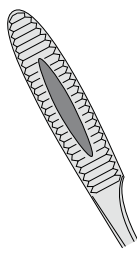

16.0463



EMMET
 16.0466 21 cm

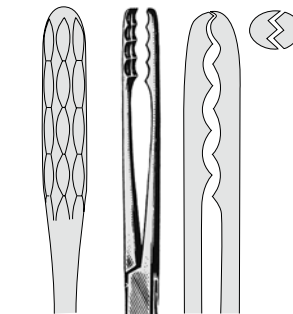

ULRICH
 16.0470 22 cm
 16.0472 25 cm

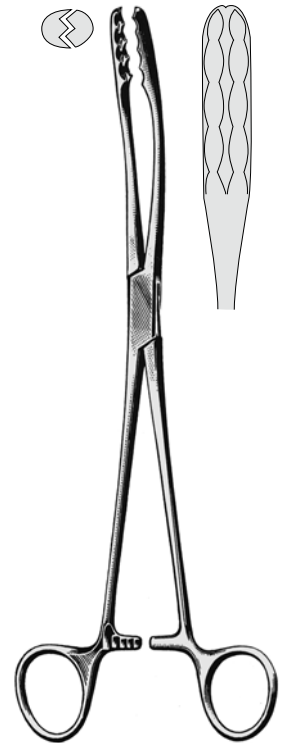

ULRICH
 16.0471 22 cm
 16.0473 25 cm

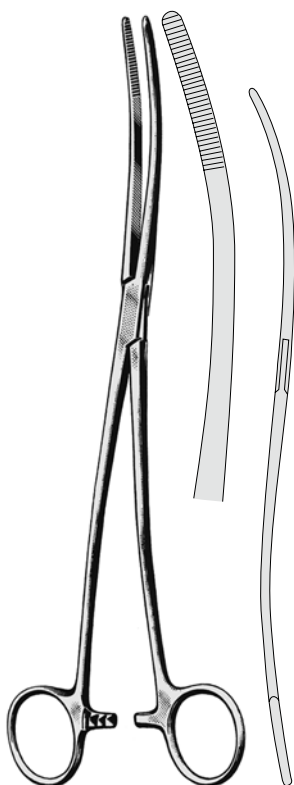

BOZEMANN

16.0500 26 cm

gerade /straight /droit /recto /retto

16.0501 26 cm

gebogen /curved / courbe /curvo /
 curvo

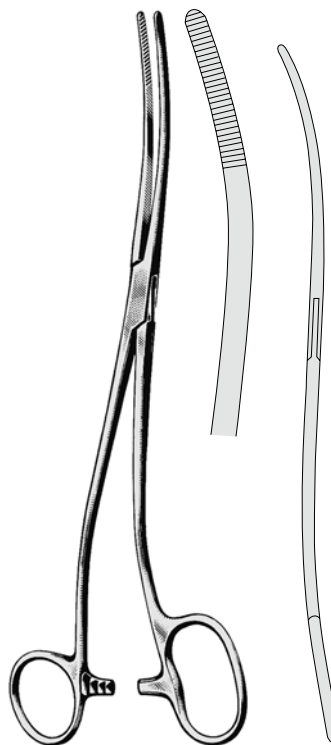

BOZEMAN-DOUGLAS

16.0505 25 cm



CHERON

16.0510 25 cm

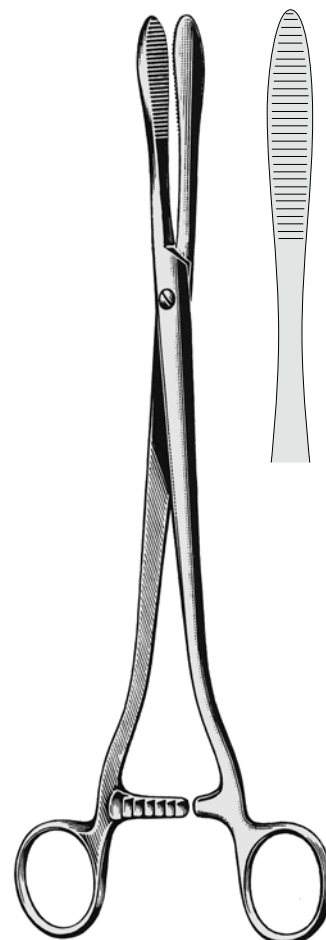

COLLIN

16.0520 25 cm