

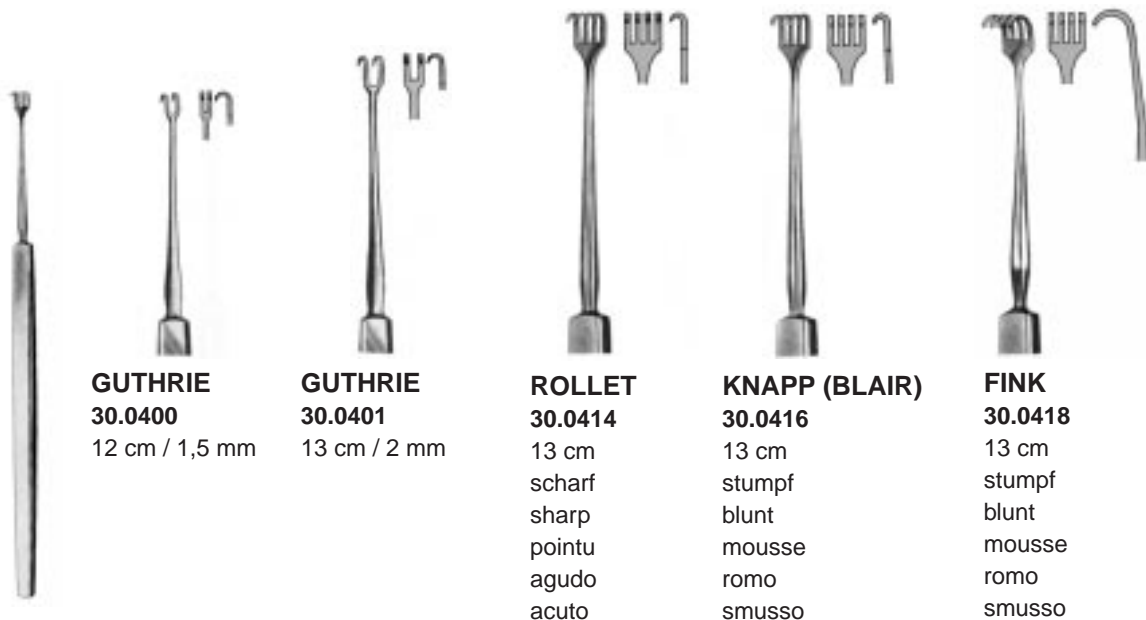

WUNDHAKEN
RETRACTORS
ECARTEURS
SEPARADORES
DIVARICATORI

FEINE WUNDHÄKCHEN
DELICATE RETRACTORS, HOOKLETS
CROCHETS, ECARTEURS FINS
GANCHITOS, SEPARADORES FINAS
DIVARICATORI FINI

Häkchen für Ophthalmologie
 Hooklets for Ophthalmology
 Crochets pour Ophthalmologie
 Ganchitos para Oftalmologia
 Uncini per Oftalmologia



GUTHRIE
30.0400
 12 cm / 1,5 mm

GUTHRIE
30.0401
 13 cm / 2 mm

ROLLET
30.0414
 13 cm
 scharf
 sharp
 pointu
 agudo
 acuto

KNAPP (BLAIR)
30.0416
 13 cm
 stumpf
 blunt
 mousse
 romo
 smusso

FINK
30.0418
 13 cm
 stumpf
 blunt
 mousse
 romo
 smusso

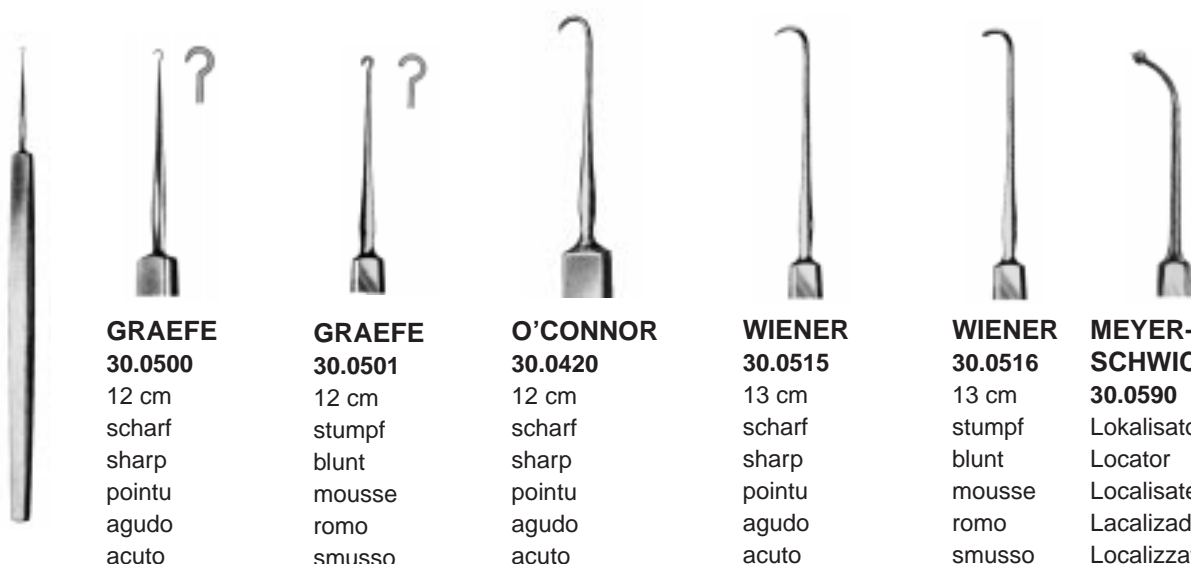

GRAEFE
30.0500
 12 cm
 scharf
 sharp
 pointu
 agudo
 acuto

GRAEFE
30.0501
 12 cm
 stumpf
 blunt
 mousse
 romo
 smusso

O'CONNOR
30.0420
 12 cm
 scharf
 sharp
 pointu
 agudo
 acuto

WIENER
30.0515
 13 cm
 scharf
 sharp
 pointu
 agudo
 acuto

WIENER
30.0516
 13 cm
 stumpf
 blunt
 mousse
 romo
 smusso

MEYER-SCHWICKERATH
30.0590
 Lokalisator
 Locator
 Localisateur
 Localizador
 Localizzatore



30.0430
 14 cm
 scharf
 sharp
 pointu
 agudo
 acuto



30.0432
 14 cm
 scharf
 sharp
 pointu
 agudo
 acuto



30.0431
 14 cm
 stumpf
 blunt
 mousse
 romo
 smusso



30.0433
 14 cm
 stumpf
 blunt
 mousse
 romo
 smusso



30.0502
 16 cm
 scharf
 sharp
 pointu
 agudo
 acuto



30.0503
 16 cm
 stumpf
 blunt
 mousse
 romo
 smusso

AXENFELD

GRAEFE



BONN
30.0510
 14 cm



TÜBINGEN
 13,5 cm



30.0511



30.0512



30.0513
 45°



30.0514



DOPPELKRALLE
 11 cm



30.0570
 rechts
 right
 à droite
 derecha
 destra



30.0571
 links
 left
 à gauche
 izquierda
 sinistra

FEINE WUNDHÄKCHEN
 DELICATE RETRACTORS, HOOKLETS
 CROCHETS, ECARTEURS FINS
 GANCHITOS, SEPARADORES FINAS
 DIVARICATORI FINI

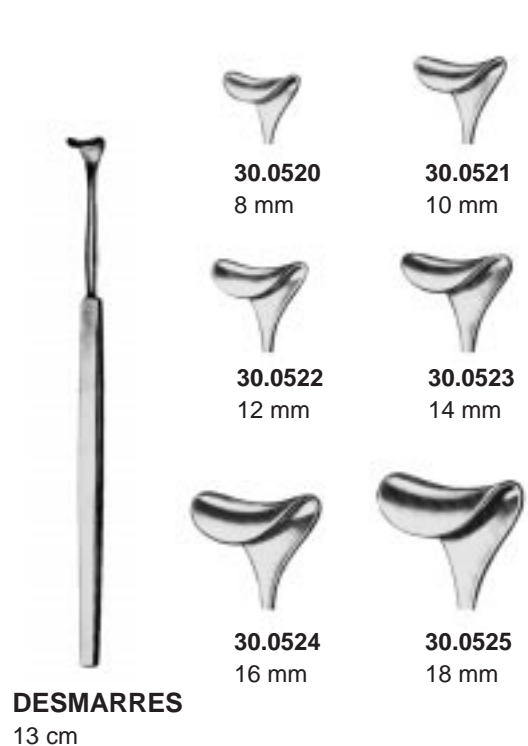

Schielhaken, Muskelhaken
 Strabismus- and Muscle hooks
 Crochets à strabisme, Crochets musculaires
 Ganchos para estrabismo y musculares
 Uncinetti per strabismo e per muscoli



Ohrhäkchen
 Ear hooklets
 Crochets auriculaires
 Ganchitos auriculares
 Uncini auricolari

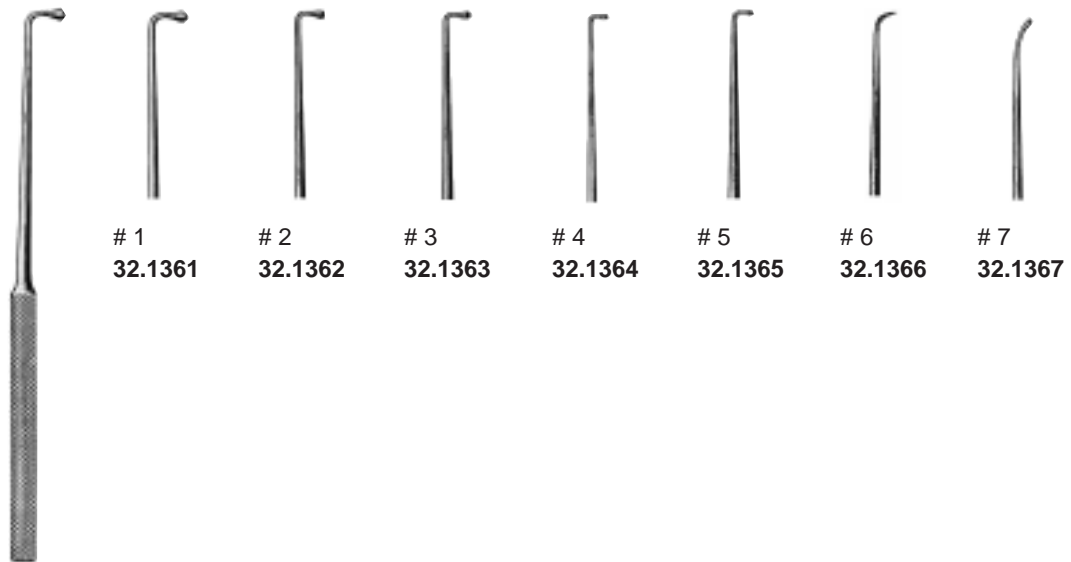

1 32.1361 # 2 32.1362 # 3 32.1363 # 4 32.1364 # 5 32.1365 # 6 32.1366 # 7 32.1367

WAGENER
 14 cm



ALLPORT
 32.1368
 16 cm



LUCAE
 14 cm



32.1376 #1

32.1377 #2

32.1378 #3



DAY
 16 cm

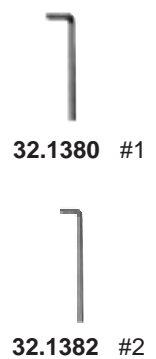

32.1380 #1

32.1382 #2

FEINE WUNDHÄKCHEN
DELICATE RETRACTORS, HOOKLETS
CROCHETS, ECARTEURS FINS
GANCHITOS, SEPARADORES FINAS
DIVARICATORI FINI

Häkchen für Rhinologie
 Hooklets for Rhinology
 Crochets pour Rhinologie
 Ganchitos para Rinologia
 Uncini per Rinologia

Schleimhauthäkchen
 Mucosa Hooklets
 Crochets pour la muqueuse
 Ganchitos para mucosa
 Uncini per mucosa



FREER
33.1910
 15 cm / 2 mm



JOSEPH
33.1911
 15 cm



JOSEPH
 16 cm



33.1912
 2 mm



33.1915
 5 mm



33.1917
 7 mm



33.1920
 10 mm



COTTLE
33.1921
 16 cm



COTTLE
 14 cm



33.1922
 scharf
 sharp
 pointu
 agudo
 acuto



33.1923
 stumpf - scharf
 blunt - sharp
 mousse - pointu
 romo - agudo
 smusso - acuto



33.1924
 scharf - stumpf
 sharp - blunt
 pointu - mousse
 agudo - romo
 acuto - smusso



COTTLE
 15 cm



33.1925
 # 1



33.1926
 # 2



33.1927
 # 3



BARSKY
 33.1929
 15 cm



FOMON
 33.1930
 17 cm



FOMON
 33.1932
 17 cm



COTTLE
 33.1935
 14 cm



MALTZ
 33.1938
 16,5 cm



LANGE
 33.1940
 22 cm

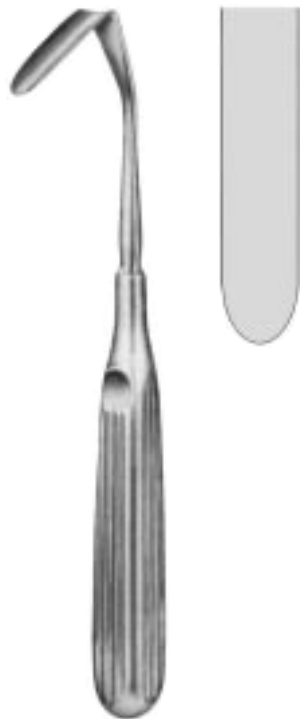

AUFRICHT
 33.1950
 19 cm



AUFRICHT
 33.1952
 13,5 cm



NEIVERT
 33.1960
 16 cm



COTTLE
 33.1962
 20 cm



KILNER
33.1966
10 cm



CONVERSE-ALAR
33.1970
12 cm



COTTLE-ALAR
33.1972
15 cm

Nasenflügelhäkchen
Alar Hooklets
Crochets pour les ailes du nez
Ganchitos para alas de nariz
Uncini per le pinne nasali



CONVERSE
33.1975
11 cm



COTTLE (Millard)
33.1976
5,5 cm

Spinalhaken
 Spinal hooks
 Ecarteurs spinaux
 Separadores espinales
 Divaricatori spinali



TAYLOR
27.1150
 75 x 30 mm
27.1152
 100 x 30 mm



CLOWARD
27.1160
 76 x 13 mm
27.1161
 76 x 18 mm
27.1162
 76 x 20 mm
27.1163
 76 x 23 mm

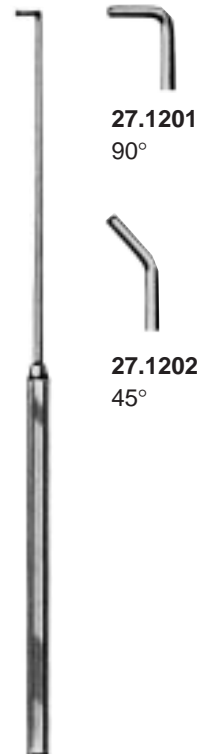

CRILE
 20 cm



HOEN
27.1206
 22 cm



ADSON
27.1210 20 cm
 spitz / sharp
 pointu / agudo / acuto



ADSON
27.1211 20 cm
 stumpf / blunt
 mousse / romo / smusso



GRAHAM
27.1220
 16,5 cm



SACHS
 27.1222
 18 cm



SMITHWICK
 27.1226
 17 cm



SMITHWICK
 27.1228
 21 cm

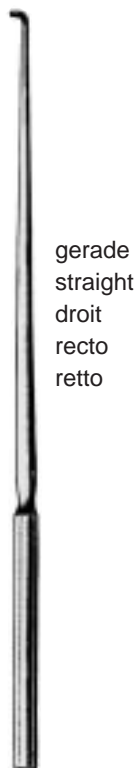

DANDY
 27.1230
 20 cm



DANDY
 27.1231
 20 cm



DANDY
 27.1232
 20 cm

gerade
 straight
 droit
 recto
 retto

links
 left
 à gauche
 izquierdo
 sinistro

rechts
 right
 à droite
 derecho
 destro



CUSHING
 27.1240 19 cm / 5 mm
 27.1245 28 cm / 5 mm



CUSHING
 27.1241 19 cm / 8 mm
 27.1246 28 cm / 8 mm



LAHEY
 27.1305
 13 cm



FRAZIER



27.1310
 13 cm
 spitz
 sharp
 pointu
 agudo
 acuto



27.1311
 13 cm
 stumpf
 blunt
 mousse
 romo
 smusso



27.1312
 18 cm
 spitz
 sharp
 pointu
 agudo
 acuto



27.1313
 18 cm
 stumpf
 blunt
 mousse
 romo
 smusso



CUSHING
 27.1320
 14 cm

schneidend
 cutting
 coupante
 cortante
 tagliente



CUSHING
 27.1325
 14 cm



CLOWARD
 27.1330
 16,5 cm



TOENNIS
 27.1340
 15 cm

NERVHÄKCHEN
 NERVE HOOKLETS
 CROCHETS A NERFS
 GANCHITOS PARA NERVIOS
 UNCINI PER NERFI



SCOVILLE
27.1390
 23 cm / 8 mm



SCOVILLE
27.1391
 23 cm / 8 mm



LOVE
27.1400
 19 cm/7 mm



LOVE
27.1402
 18 cm/7 mm



LOVE
27.1404
 11 cm/7 mm



LOVE
27.1406
 21 cm



SCOVILLE
27.1410
30,5 cm



SCOVILLE
27.1412
30,5 cm



HOLSHER
27.1413
25 cm / 7 mm



CUSHING
27.1420
20 cm

Dekompressionshaken
Decompression hook
Crochet pour décompression
Gancho para decompresión
Gancio per decompressione



D'ERRICO
27.1425
23 cm

Nervwurzelhaken
Nerve root retractor
Rétracteur pour racines nerveuses
Separador para la raíz de nervios
Separatore per le radici die nervi



OLDBERG
20 cm



27.1430



27.1431



27.1432



27.1433

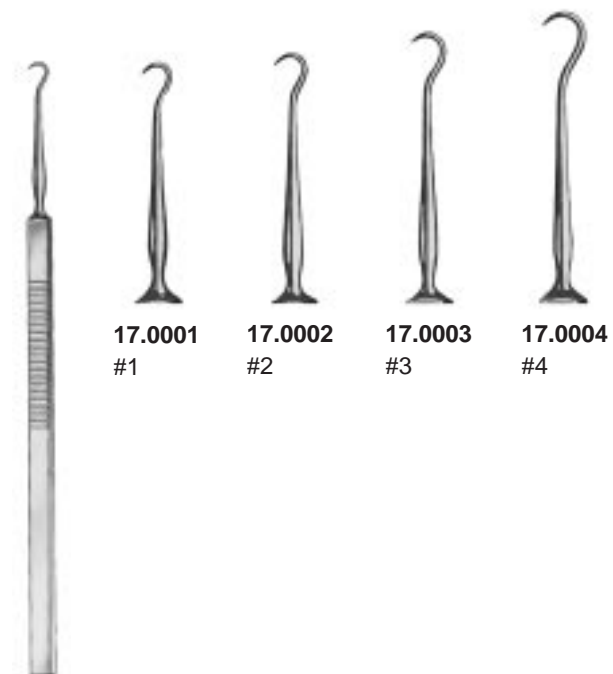

17.0001 #1
 17.0002 #2
 17.0003 #3
 17.0004 #4

Gefäßhäkchen
 Vessel Hook
 Crochet pour vaisseaux
 Ganchito vascular
 Uncino vascolare



17.0012
 12 cm



BERGMANN
 17.0037
 14 cm

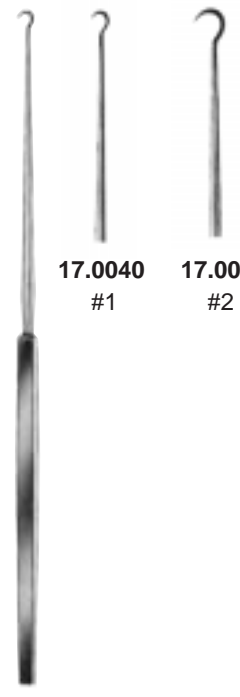

17.0040 #1
 17.0041 #2

GILLIES
 18 cm

16 cm



GILLIES
 17.0043 18 cm

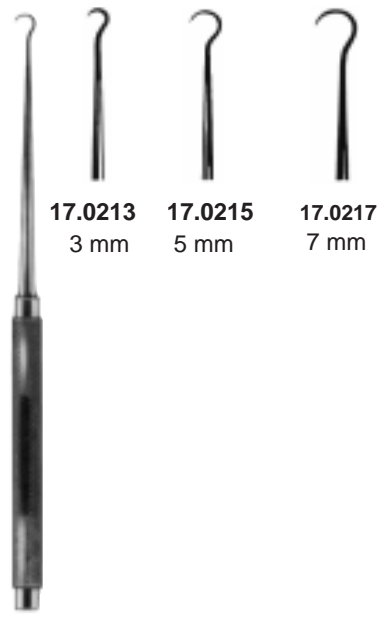

17.0213 3 mm
 17.0215 5 mm
 17.0217 7 mm

KLEINERT-KUTZ
 13 cm



KILNER
 58.0010 15,5 cm



17.0050 17.0052

Venenhäkchen
 Vein Hooks
 Crochets pour veines
 Ganchitos para venas
 Uncini per veni

BROM
 19 cm

FEINE WUNDHÄKCHEN
 DELICATE RETRACTORS, HOOKLETS
 CROCHETS, ECARTEURS FINS
 GANCHITOS, SEPARADORES FINAS
 DIVARICATORI FINI



MANNERFELT
 17.1901
 13,5 cm



MANNERFELT
 17.1902
 15,5 cm



MANNERFELT
 17.1904
 15,5 cm

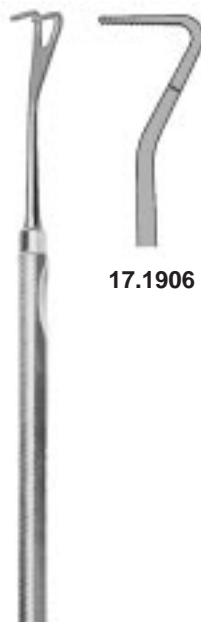

MANNERFELT
 17.1906
 15,5 cm



17.1908



MANNERFELT
 17.1933
 15,5 cm

flexibel
 flexible
 flexible
 flexible
 flessibile



17.1911



17.1912



17.1913

MANNERFELT
 15,5 cm
 spitz
 sharp
 pointu
 agudo
 acuto



17.1916



17.1917



17.1918

MANNERFELT
 15,5 cm
 stumpf
 blunt
 mousse
 romo
 smusso



17.1921



17.1922



17.1923

MANNERFELT
 15,5 cm
 spitz
 sharp
 pointu
 agudo
 acuto



17.1926



17.1927



17.1928

MANNERFELT
 15,5 cm
 stumpf
 blunt
 mousse
 romo
 smusso



MANNERFELT
15,5 cm



17.1940 16x6 mm



MANNERFELT
15,5 cm



17.1943 15x6 mm



17.1944 20x6 mm



17.1945 25x6 mm



17.1946 30x8 mm



MANNERFELT
15,5 cm



17.1948 12x12 mm



17.1949 12x14 mm



17.1951 14x16 mm



MANNERFELT
15,5 cm



17.1958 12x12 mm

FEINE WUNDHÄKCHEN
DELICATE RETRACTORS, HOOKLETS
CROCHETS, ECARTEURS FINS
GANCHITOS, SEPARADORES FINAS
DIVARICATORI FINI



MILLER
13,5 cm



17.0480
spitz
sharp
pointu
agudo
acuto

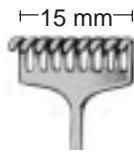

17.0481
stumpf
blunt
mousse
romo
smusso



17.0390 16,5 mm
spitz
sharp
pointu
agudo
acuto



17.0391 16,5 mm
stumpf
blunt
mousse
romo
smusso

Trachealhäkchen / Trachea hooklets / Crochets pour trachéotomie / Ganchitos para la tráquea / Uncini tracheali



17.0401 - 17.0414
16 cm



17.0401



17.0411



17.0402



17.0412



17.0403



17.0413



17.0404
spitz/sharp
pointu /agudo
acuto



17.0414
stumpf/blunt
mousse/romo
smusso

flexibel
flexible
flexible
flexible
flessibile



17.0421 - 17.0434
16 cm



17.0421



17.0431



17.0422



17.0432



17.0423



17.0433



17.0424
spitz/sharp
pointu /agudo
acuto



17.0434
stumpf/blunt
mousse/romo
smusso



MEYERDING
 18 cm



17.0451 #1



17.0452 #2



17.0453 #3



17.0454 #4



17.0455 #5



17.0456 #6



17 cm



17.0471



17.0472



17.0473



17.0474

spitz
 sharp
 pointu
 agudo
 acuto



17.0476



17.0477



17.0478



17.0479

stumpf
 blunt
 mousse
 romo
 smusso

FEINE WUNDHÄKCHEN
 DELICATE RETRACTORS, HOOKLETS
 CROCHETS, ECARTEURS FINS
 GANCHITOS, SEPARADORES FINAS
 DIVARICATORI FINI

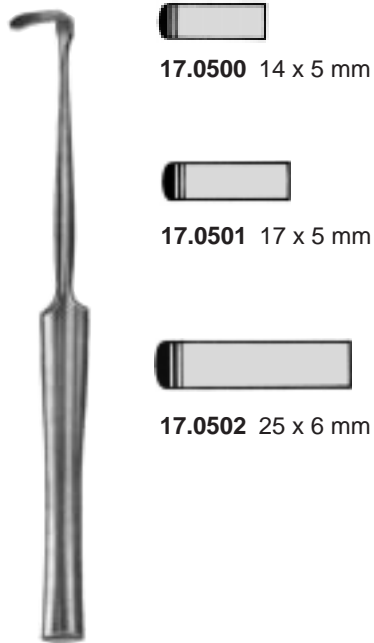

17.0500 14 x 5 mm

17.0501 17 x 5 mm

17.0502 25 x 6 mm

MOBERG
17 cm



15 x 6 mm

gezahnt
serrated
dentée
dentada
dentata

STRANDELL-STILLE
17.0510 19 cm

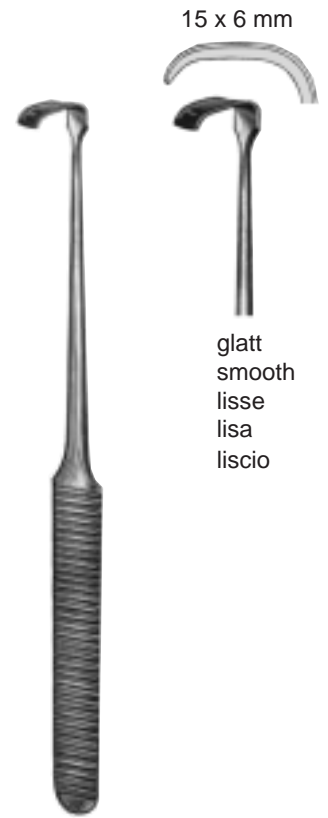

15 x 6 mm

glatt
smooth
lisse
lisa
liscio

STRANDELL-STILLE
17.0512 19 cm



17.0515

17.0516

KLAPP
17,5 cm



17.0520
13 x 13 mm

17.0522
12 x 16 mm

KÖNIG
18 cm



CRILE
 17.0530 11 cm



LUER
 17.0535 11 cm



HOUSE
 17.0540 15 cm



RAGNELL-DAVIS
 17.0585 14 cm



SENN-MILLER
 17.0580, 17.0581
 16 cm



17.0580
 17.0588



17.0581
 17.0589



MATHIEU
 17.0588, 17.0589
 16 cm



SENN-MILLER-BABY
 15 cm



17.0582



17.0583



COPE
 17.0566
 18 cm



JACKSON
 36.0500
 13 cm



JACKSON
 18 cm



36.0502
 spitz
 sharp
 pointu
 agudo
 acuto



36.0503
 stumpf
 blunt
 mousse
 romo
 smusso



JACKSON
 36.0504
 18 cm



ROSE
 36.0550
 13 cm

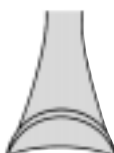

NEWS
 36.0560
 15 cm



LUKENS
 36.0600
 17 cm





SENN-GREEN
15 cm



17.0560
10 x 6 mm



17.0562
20 x 6 mm



LANGENBECK-MINI
16 cm



17.0590
10 x 6 mm



17.0591
17 x 5 mm



17.0592
20 x 6 mm



17.0593
22 x 8 mm

SATTELHAKEN
 SADDLE HOOKS
 GANCHOS "SILLA"
 ECARTEURS EN FORMA DE SELLE
 DIVARICATORI A FORMA DI SELLA



17.0460
5 mm



17.0461
7 mm



17.0462
10 mm



17.0463
12 mm

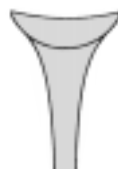

17.0464
15 mm

KIRKLIN

17.0460-17.0464

13 cm,
 biegsam/malleable
 malléable/maleable
 malleabili



CUSHING
20 cm



17.0570
11 x 14 mm



17.0571
13 x 17 mm



CUSHING
25 cm



17.0577
14 x 11 mm



17.0578
18 x 13 mm



17.0579
22 x 15 mm



CUSHING
17.0575
21 cm 10 x 11 mm



MARBERGER
 20 cm



17.0671 8 mm



17.0672 11 mm



17.0673 15 mm



17.0674 17 mm



17.0675 20 mm



17.0676 23 mm

biegsam
 malleable
 malléable
 maleable
 malleabili



GIL-VERNET
 24 cm



17.0680 9 mm



17.0681 11 mm



17.0682 13 mm



17.0683 15 mm



17.0684 18 mm

biegsam
 malleable
 malléable
 maleable
 malleabili

SATTELHAKEN
SADDLE HOOKS
GANCHOS "SILLA"
ECARTEURS EN FORMA DE SELLE
DIVARICATORI A FORMA DI SELLA





SPERMATIC
 51.0060
 16 cm

Samenstranghaken
 Spermatic cord hook
 Crochet pour cordon spermatic
 Gancho para cordón espermático
 Uncino per cordone spermatico



EMMET
 22 cm



55.1551
 # 1



55.1552
 # 2



55.1553
 # 3



55.1554
 # 4



55.1555
 # 5

Fistelhaken
 Fistula hooks
 Crochets pour fistules
 Ganchitos para fistulas
 Uncini per fistole



SIMON
 55.1561
 22 cm



SIMON
 55.1562
 22 cm

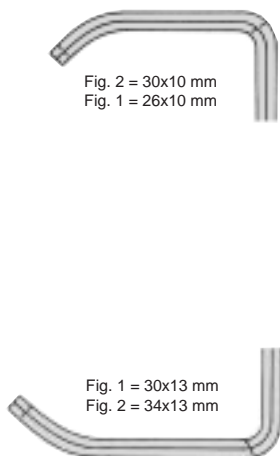

Fig. 2 = 30x10 mm
Fig. 1 = 26x10 mm

Fig. 1 = 30x13 mm
Fig. 2 = 34x13 mm

FARABEUF
17.0600 12 cm

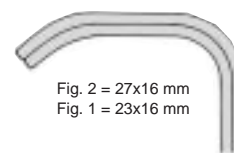

Fig. 2 = 27x16 mm
Fig. 1 = 23x16 mm

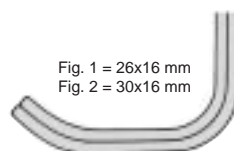

Fig. 1 = 26x16 mm
Fig. 2 = 30x16 mm

FARABEUF
17.602 15 cm

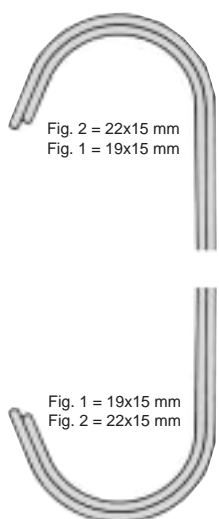

Fig. 2 = 22x15 mm
Fig. 1 = 19x15 mm

Fig. 1 = 19x15 mm
Fig. 2 = 22x15 mm

PARKER
17.0610 13,5 cm

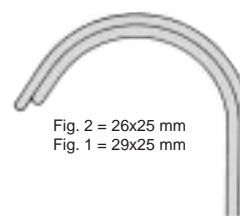

Fig. 2 = 26x25 mm
Fig. 1 = 29x25 mm

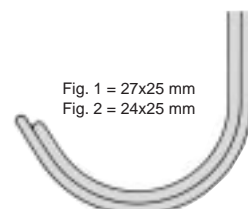
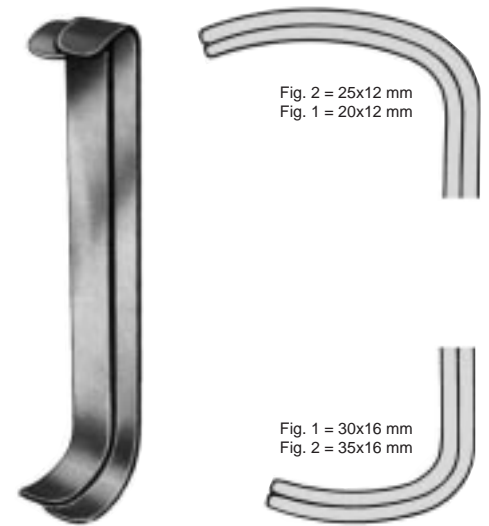

Fig. 1 = 27x25 mm
Fig. 2 = 24x25 mm

PARKER
17.0612 18 cm



PARKER-MOTT
 17.0615 16 cm



COLLIN
 17.0619 16 cm

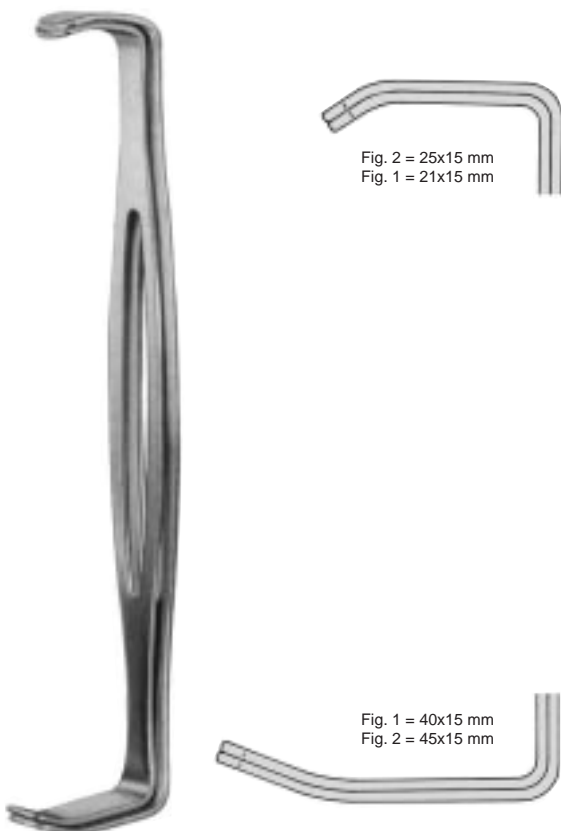

US-ARMY
 17.0630 21cm



17.0631 19 cm
 16x35 mm
17.0632 19 cm
 19x28 mm
17.0633 20 cm
 25x32 mm

CANNY-RYALL

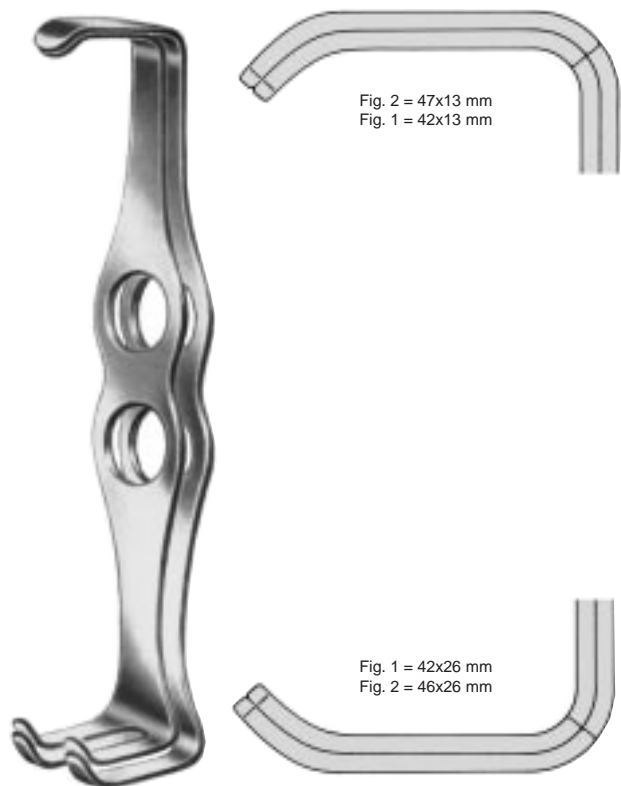

MATHIEU
 17.0635 20 cm

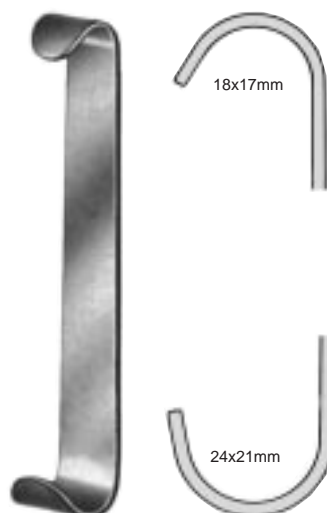

ROUX-BABY
 17.0650 13 cm



ROUX-MINI
 17.0654 14 cm



ROUX
 17.0659
 Satz #1-3 15/16/17 cm

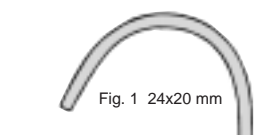

17.0655 15 cm

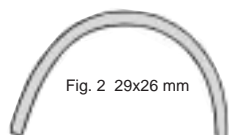

17.0656 16 cm

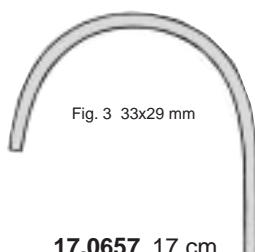

17.0657 17 cm



COLLIN-HARTMANN
 17.0660 16 cm



CZERNY
 17.0662 18 cm



MORRIS
 24cm
 17.0665 32x51/38x51 mm
 17.0666 44x51/51x51 mm
 17.0667 64x51/38x51 mm

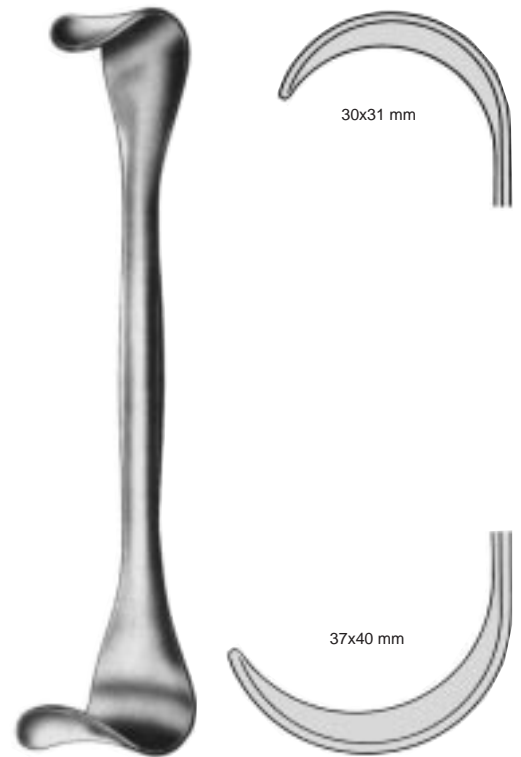

GOELET
 17.0670 19 cm

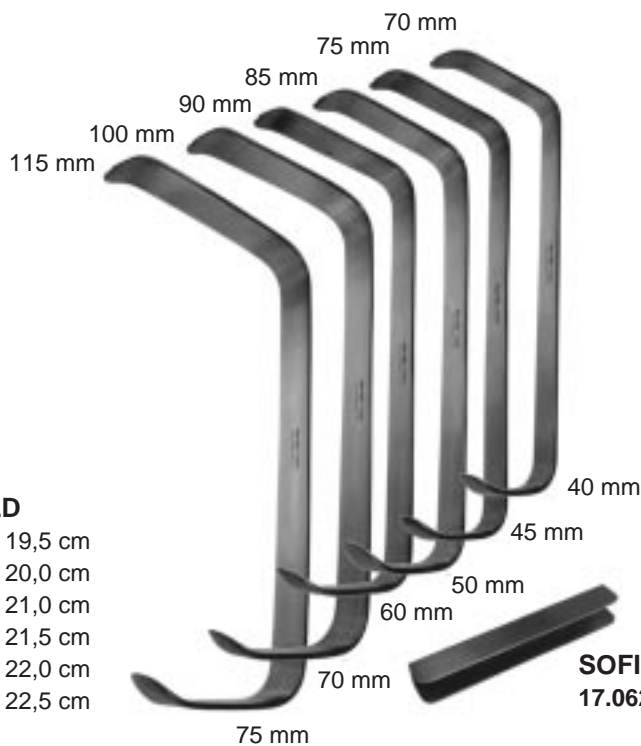

SOFIELD
 17.0621 19,5 cm
 17.0622 20,0 cm
 17.0623 21,0 cm
 17.0624 21,5 cm
 17.0625 22,0 cm
 17.0626 22,5 cm

SOFIELD
 17.0629



SOFIELD
 17.0620



VOLKMANN
 11,5 cm

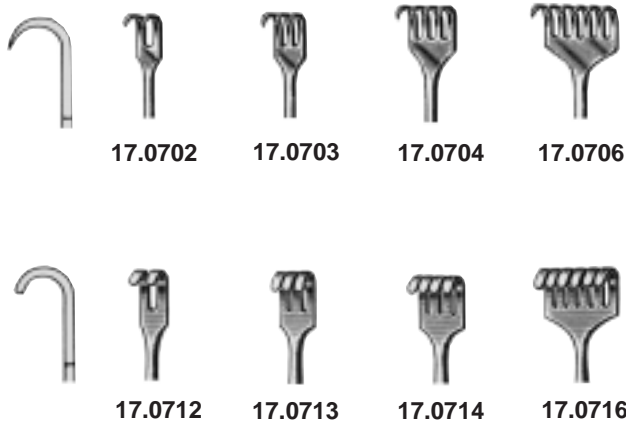

scharf / sharp / pointu / agudo / acuto



VOLKMANN
 21,5 cm



stumpf / blunt / mousse / romo / smusso



halbscharf / semi-sharp / semi-pointu / semiagudo / semi acuto



VOLKMANN
21,5 cm



17.0801



17.0802



17.0803



17.0804



17.0806

scharf / sharp / pointu / agudo / acuto



17.0811



17.0812



17.0813



17.0814

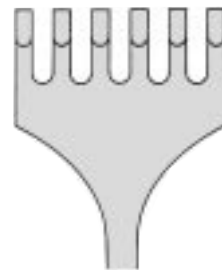

17.0816

stumpf / blunt / mousse / romo / smusso



17.0751



17.0752



17.0753



17.0754



17.0756



17.0758

scharf / sharp / pointu / agudo / acuto



17.0761



17.0762



17.0763



17.0764



17.0766



17.0768

stumpf / blunt / mousse / romo / smusso



KOCHER
 22 cm



17.0771



17.0772



17.0773



17.0774



17.0776



17.0778

halbscharf / semi-sharp / semi-pointu / semi-agudo / semi acuto

Knochenhaken/Bone Retractors/Ecarteurs pour os/Separadores para huesos/Divaricatore per ossi



17.0780
25 cm



17.0781



17.0782



17.0784

VOLKMANN
22 cm



MURPHY
19 cm



17.0822



17.0823

scharf / sharp / pointu / agudo / acuto



17.0824



17.0826



17.0832



17.0833

stumpf / blunt / mousse / romo / smusso



17.0834



17.0836



WASSMUND
 17.0900 20 cm
 33 x 20 mm



OLLIER
 17.0912 22,5 cm
 36 x 60 mm



17.0910
 36 x 30 mm



KOERTE
 17.0922 24 cm
 stumpf
 blunt
 mousse
 romo
 smusso

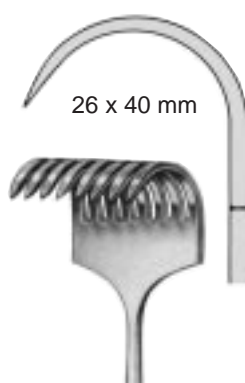

17.0920
 scharf
 sharp
 pointu
 agudo
 acuto



KOERTE
 17.0925
 23 cm
 stumpf
 blunt
 mousse
 romo
 smusso



ISRAEL
25 cm



17.0930
40 x 40 mm



17.0931
45 x 50 mm



17.0932
50 x 60 mm



17.0934
70 x 70 mm



28 x 6 mm

LAHEY
17.1000 19 cm



12 x 14 mm

LITTLE
17.1010 20 cm

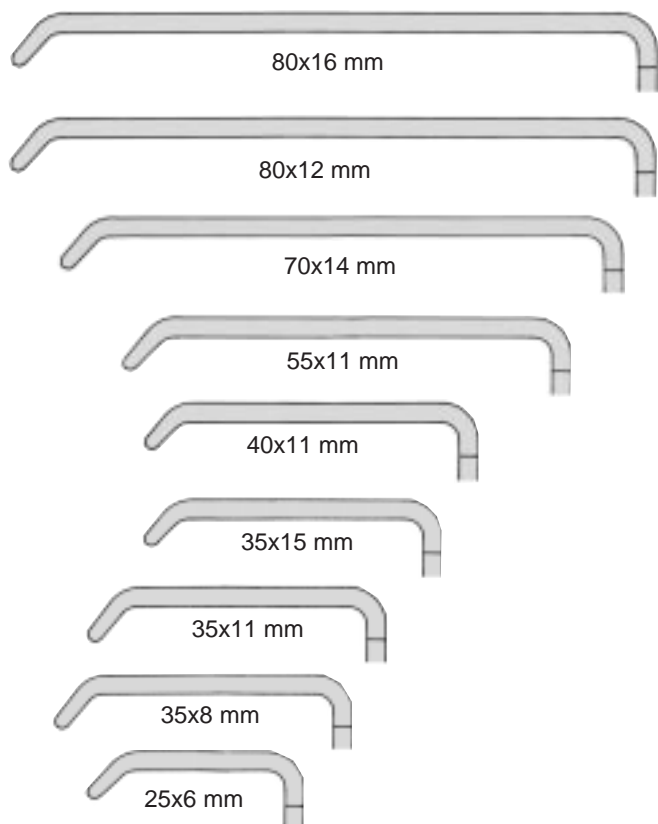

KOCHER-LANGENBECK

21 cm

- 17.1011** 25 x 6 mm
- 17.1012** 35 x 8 mm
- 17.1013** 35 x 11 mm
- 17.1014** 35 x 15 mm
- 17.1015** 40 x 11 mm
- 17.1016** 55 x 11 mm
- 17.1017** 70 x 14 mm
- 17.1018** 80 x 12 mm
- 17.1019** 80 x 16 mm

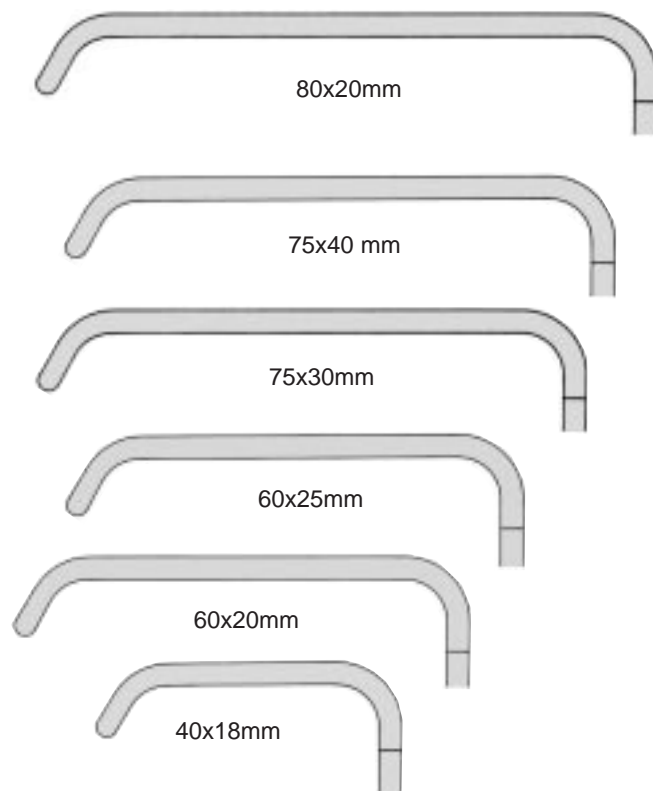

KOCHER

23 cm

- 17.1020** 40 x 18 mm
- 17.1021** 60 x 20 mm
- 17.1022** 60 x 25 mm
- 17.1023** 75 x 30 mm
- 17.1024** 75 x 40 mm
- 17.1025** 80 x 20 mm



LANGENBECK
 17.1040 - 17.1045
 22 cm



17.1040 30 x 11 mm
17.1050 30 x 11 mm



17.1043 40 x 11 mm
17.1053 40 x 11 mm



17.1041 30 x 14 mm
17.1051 30 x 14 mm



17.1044 40 x 15 mm
17.1054 40 x 15 mm



17.1042 30 x 16 mm
17.1052 30 x 16 mm



17.1045 50 x 11 mm
17.1055 50 x 11 mm



LANGENBECK
 17.1050 - 17.1055
 22 cm

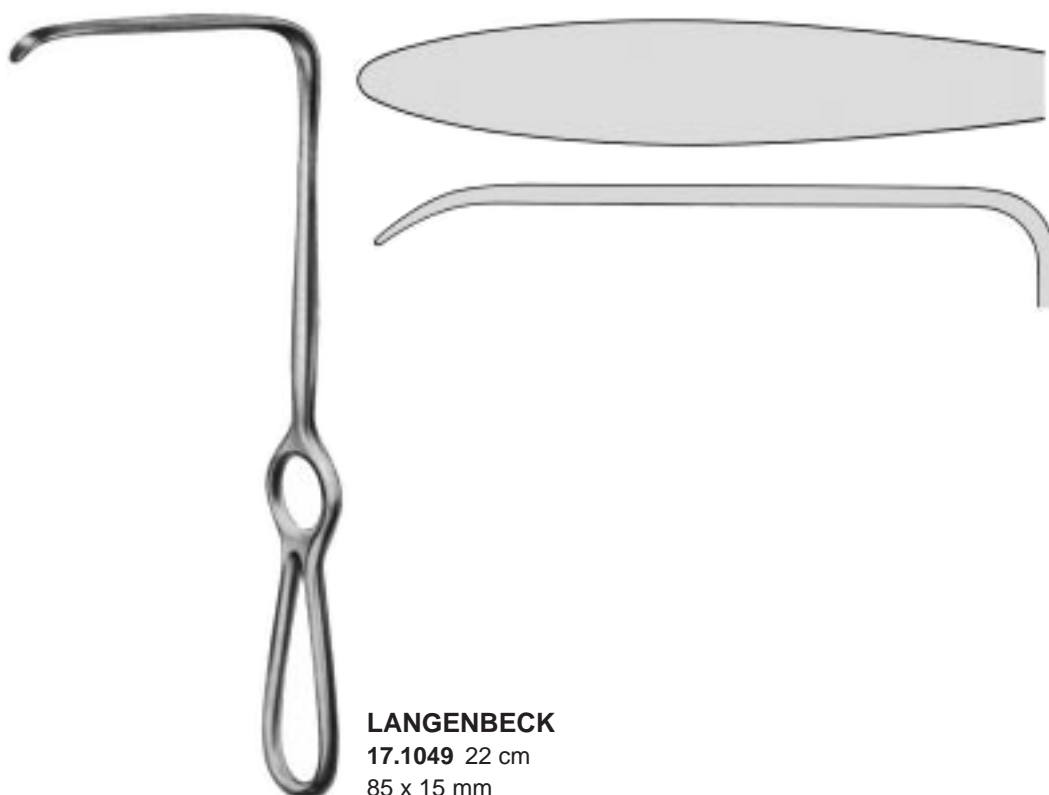

LANGENBECK
17.1049 22 cm
 85 x 15 mm

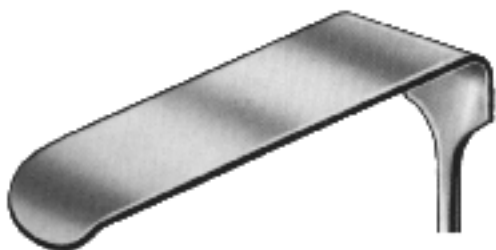

LANGENBECK
17.1056 60 x 20 mm
22 cm



17.1060 55 x 20 mm

LANGENBECK
22 cm

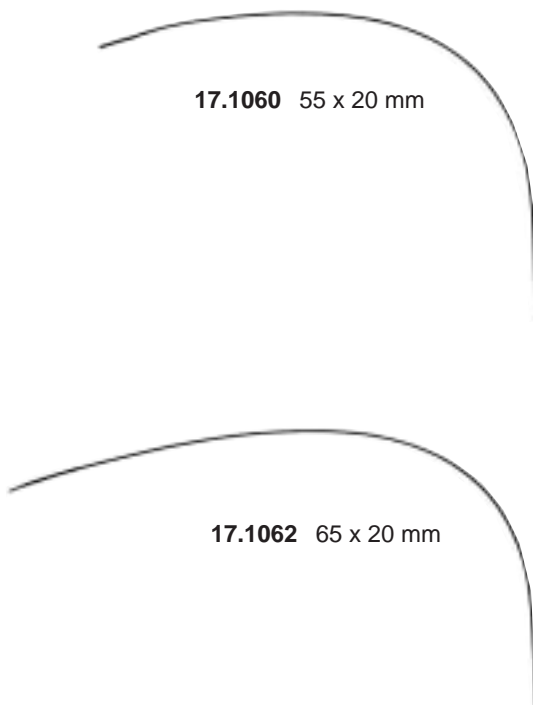

17.1062 65 x 20 mm



67 x 17 mm

CASPAR
17.1068
20 cm



KOCHER

19 cm

17.1070 19 x 12 mm

17.1071 21 x 14 mm



KOCHER

22 cm

17.1072 40 x 10 mm

17.1073 40 x 15 mm

17.1074 40 x 20 mm



KOCHER

23 cm

17.1075 70 x 25 mm



KOCHER

25 cm

17.1076 80 x 45 mm

17.1077 80 x 55 mm

17.1078 80 x 65 mm



MIDDELDORPF

22 cm

17.1080 16 x 17 mm

17.1081 20 x 22 mm

17.1082 26 x 30 mm



MIDDELDORPF

26 cm

17.1083 45 x 45 mm

17.1084 45 x 50 mm

17.1085 55 x 70 mm



MIDDELDORPF
23 cm
17.1086 20 x 22 mm
17.1087 26 x 30 mm



GREEN
22 cm
17.1088 12 x 25 mm
Schilddrüsenhaken
Thyroid gland retractor
Ecarteur pour la thyroïde
Separador par la glándula tiroidea
Divaricatore per la tiroide



RICHARDSON
24 cm
17.1090 28 x 20 mm
17.1091 36 x 28 mm
17.1092 44 x 38 mm



RICHARDSON-EASTMANN
49 x 38 mm
28 x 20 mm
36 x 28 mm
71 x 43 mm
17.1097 Satz/Set/Jeu/Juego/Serie
17.1098 Klein/small/petit/chico/piccolo
17.1099 Groß/large/grand/grande/grande



KELLY

26 cm

17.1095 65 x 50 mm

17.1096 70 x 63 mm



KELLY

23,5 cm

17.1101 38 x 51 mm

17.1102 51 x 64 mm

25,5 cm

17.1103 64 x 76 mm

17.1104 76 x 89 mm



KELLY

26 cm

17.1118 160 x 38 mm

17.1119 160 x 57 mm

17.1093 190 x 38 mm

17.1094 190 x 57 mm



DOYEN
25 cm
17.1100 85 x 50 mm



DOYEN-STILLE
20 cm
17.1105 90 x 28 mm
17.1106 105 x 30 mm
17.1107 120 x 52 mm



MORRIS
21 cm
17.1108 38 x 51 mm
17.1109 51 x 51 mm
17.1110 64 x 51 mm



17.1117 220x30mm

ohne Abb. / without illustration / sans illustration / sin ilustración / senza illustrazione



FRITSCH

24 cm

17.1120 35 x 40 mm

17.1121 45 x 40 mm

17.1122 45 x 50 mm

17.1123 45 x 60 mm

17.1124 55 x 75 mm

17.1125 65 x 80 mm



KOCHER-WAGNER

28 cm

17.1130 22 x 15 mm

17.1131 38 x 20 mm

17.1132 67 x 25 mm

17.1133 100 x 35 mm



TUEBINGEN

17.1154 28 cm

95 x 20 mm



MARTIN
17.1156 26 cm
105 x 27 mm

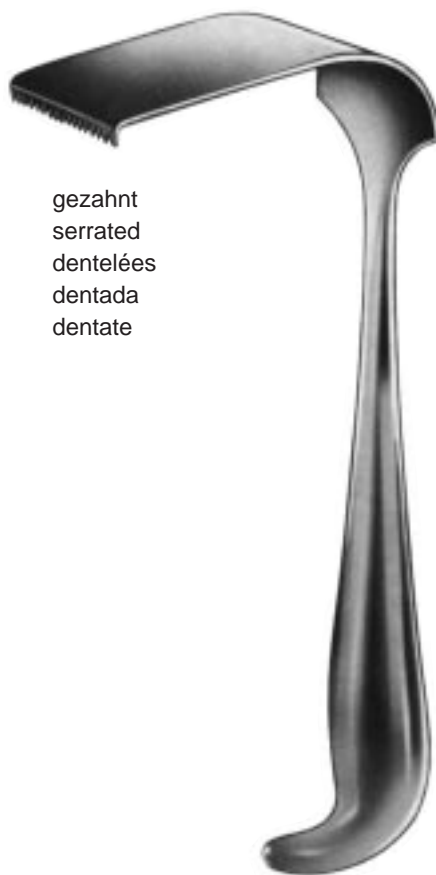

gezahnt
serrated
dentelées
dentada
dentate

MEYERDING
17.1160 22 cm
50 x 16 mm
17.1162 22 cm
75 x 25 cm
17.1164 24 cm
90 x 50 mm



MIKULICZ
17.1165 24 cm
90 x 50 mm



MIKULICZ
24 cm
17.1166 95 x 35 mm



MIKULICZ
26 cm
17.1167 120 x 50 mm
17.1168 155 x 50 mm
17.1169 180 x 50 mm



SAUERBRUCH
23 cm
17.1170 45 x 15 mm
17.1171 60 x 23 mm
17.1172 75 x 20 mm



17.1181
115 x 38 mm

17.1180
82 x 22 mm

CORYLLOS
24 cm
17.1182 115 x 65 mm

SAUERBRUCH
17.1176 25 cm
125 x 37 mm

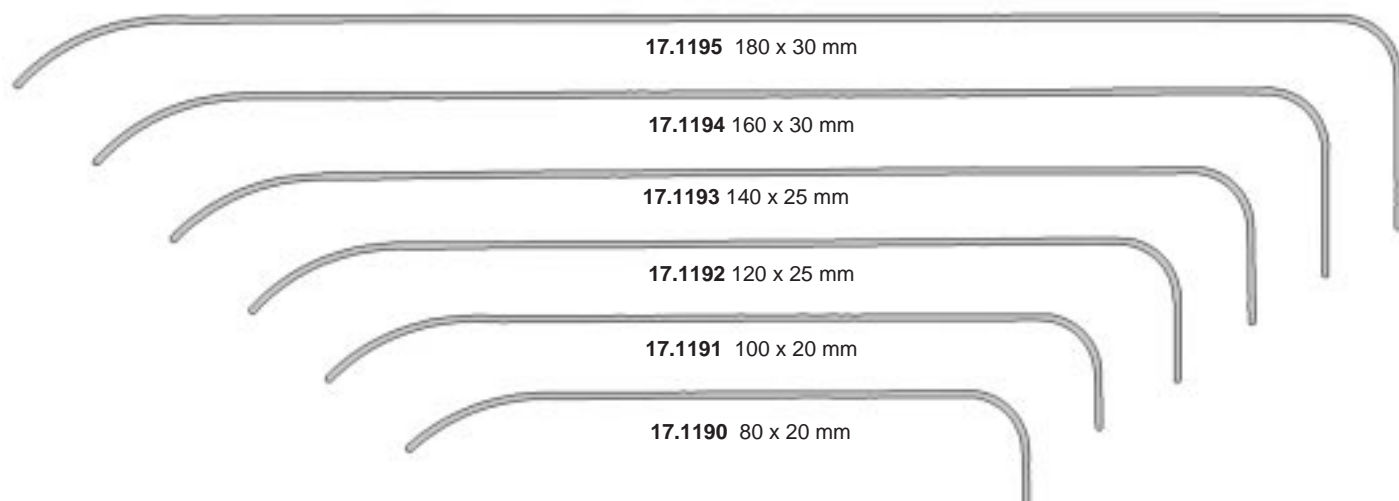

BRUNNER
17.1190 - 17.1195
25 cm

17.1209 180 x 30 mm

17.1208 160 x 30 mm

17.11207 140 x 30 mm

17.1206 130 x 30 mm

17.1205 120 x 25 mm

17.1204 100 x 25 mm

17.1203 80 x 20 mm



BRUNNER
17.1203 - 17.1209

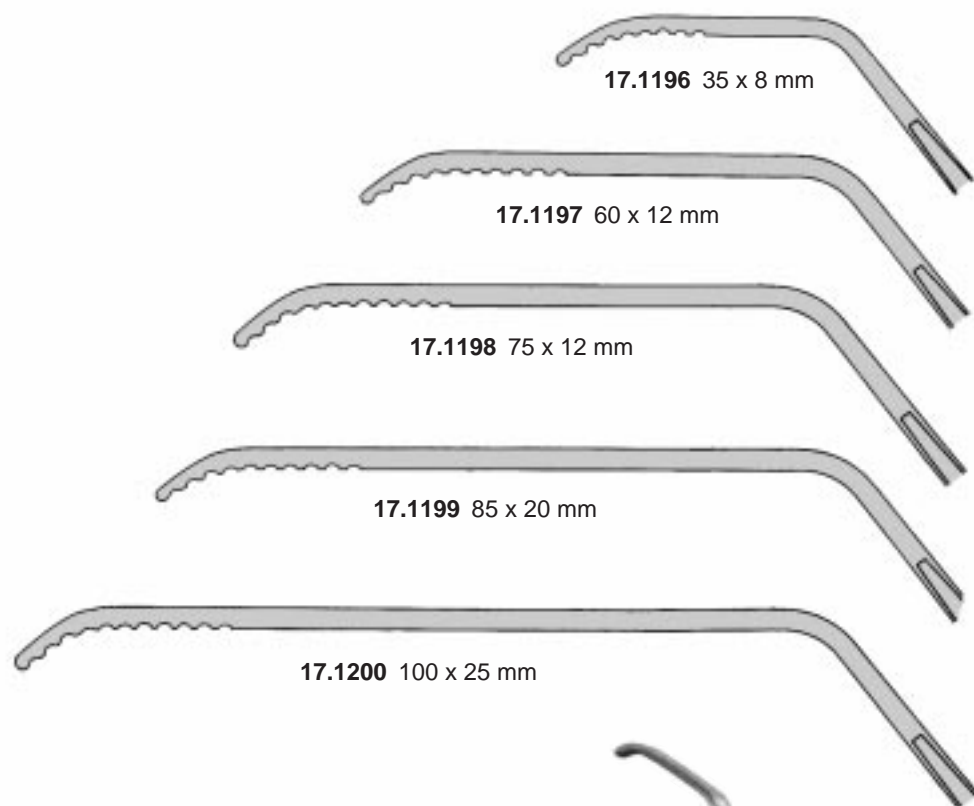

ZENKER
17.1196 - 17.1200
26 cm

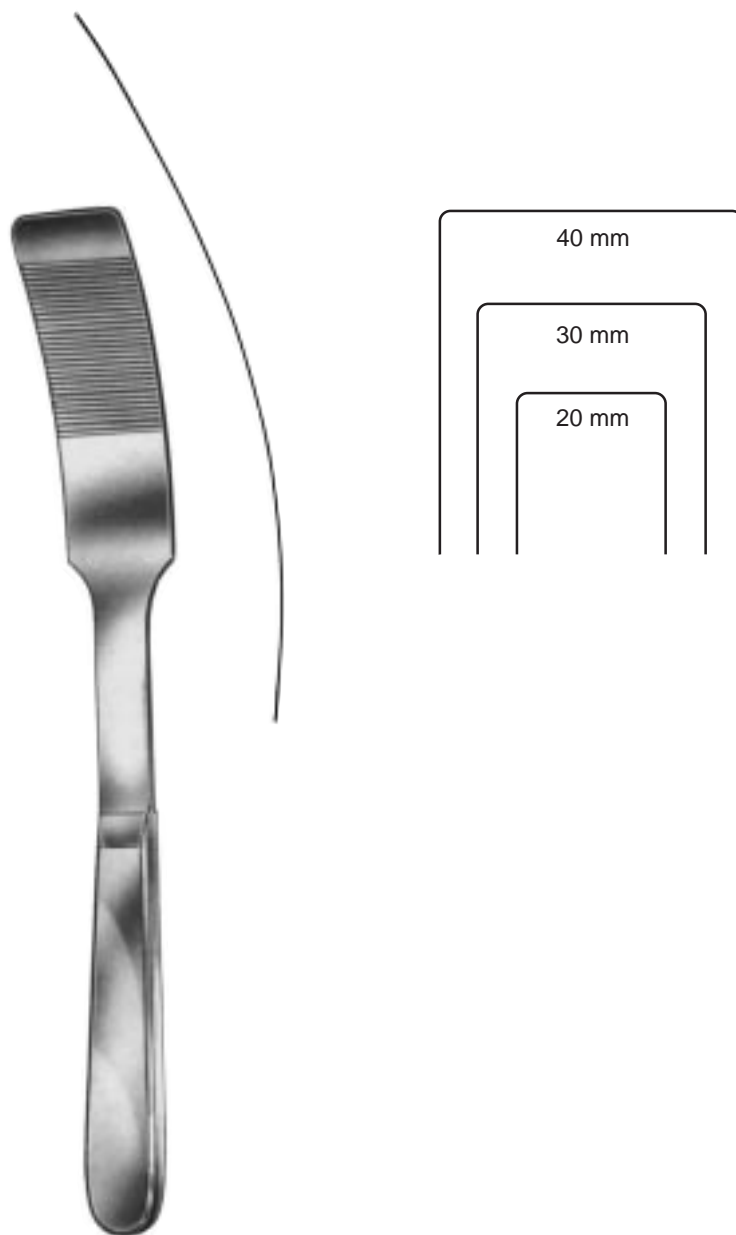

KADER

27 cm

17.1232 20 mm

17.1233 30 mm

17.1234 40 mm



RIBBON

17.1210 200 x 6 mm
 17.1211 200 x 8 mm
 17.1212 200 x 10 mm
 17.1213 200 x 12 mm

17.1214 200 x 17 mm
 17.1215 200 x 20 mm
 17.1216 200 x 25 mm
 17.1217 250 x 25 mm

biegsam
 malleable
 malléable
 maleable
 malleabili



RIBBON

17.1219 330 x 19 mm
 17.1220 330 x 25 mm
 17.1222 330 x 30 mm

17.1224 330 x 40 mm
 17.1226 330 x 50 mm

biegsam
 malleable
 malléable
 maleable
 malleabili



TUFFIER

17.1240 20 cm

25 / 17 mm

biegsam
 malleable
 malléable
 maleable
 malleabili



HABERER

17.1255 30 cm 37/45 mm
 17.1256 28 cm 25/30 mm
 17.1257 20 cm 17/25 mm

biegsam
 malleable
 malléable
 maleable
 malleabili



REVERDIN

17.1250 29 cm
 45x60 mm



REVERDIN

17.1251 28 cm
 45x60 mm

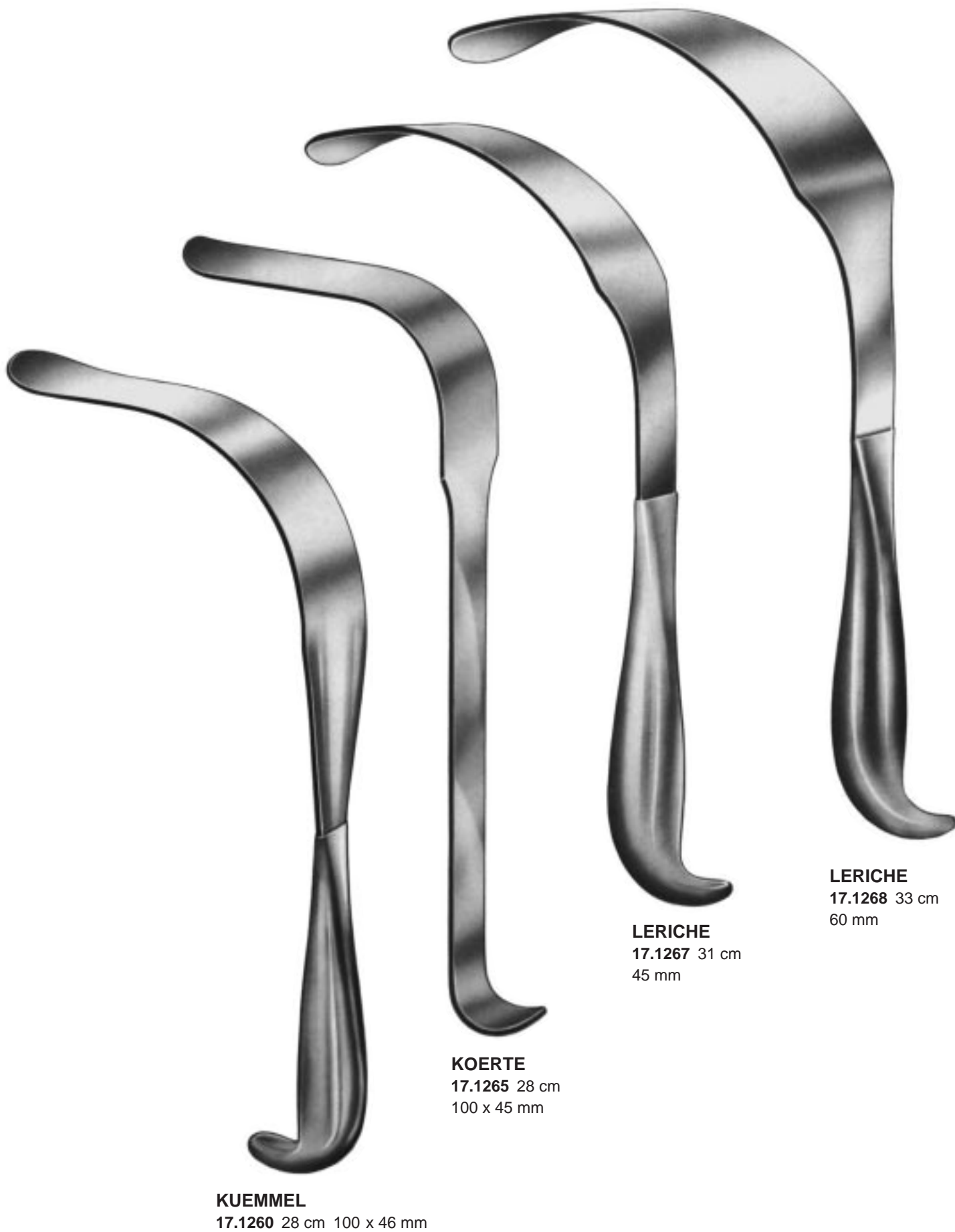



DEAVER
17.1273C-17.1279C

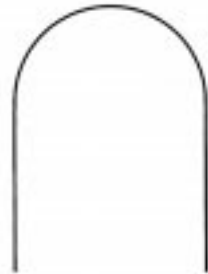

17.1273C
300 x 25 mm

17.1274C
330 x 25 mm



17.1276C
330 x 38 mm

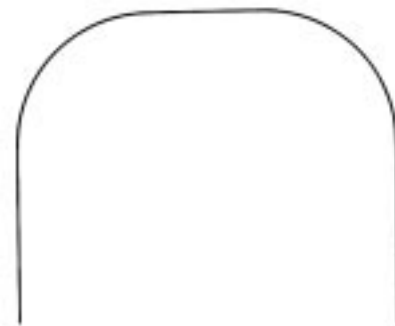

17.1277C
330 x 50 mm

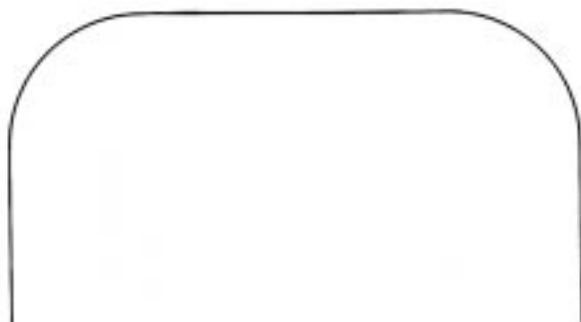

17.1278C
330 x 75 mm



17.1279C
330 x 100 mm



DEAVER
17.1270
180 x 19 cm

DEAVER
17.1271
215 x 22 mm

DEAVER
17.1272
230 x 25 mm

DEAVER
17.1273
300 x 25 mm

DEAVER
17.1274
330 x 25 mm

DEAVER
17.1275
360 x 25 mm



DEAVER
17.1276 300 x 38 mm



DEAVER
17.1277 300 x 50 mm



DEAVER
17.1278 300 x 75 mm
17.1279 330 x 100 mm

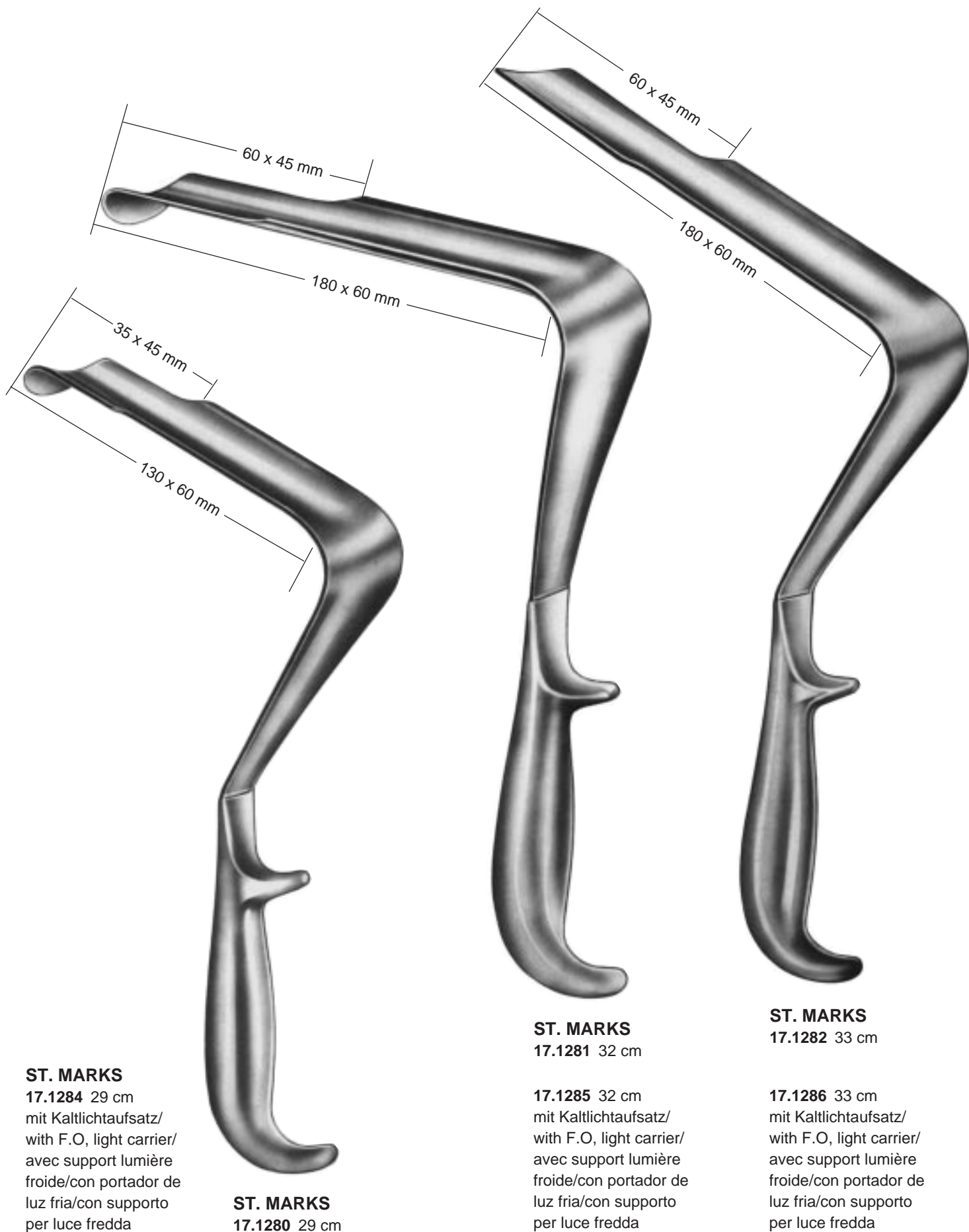

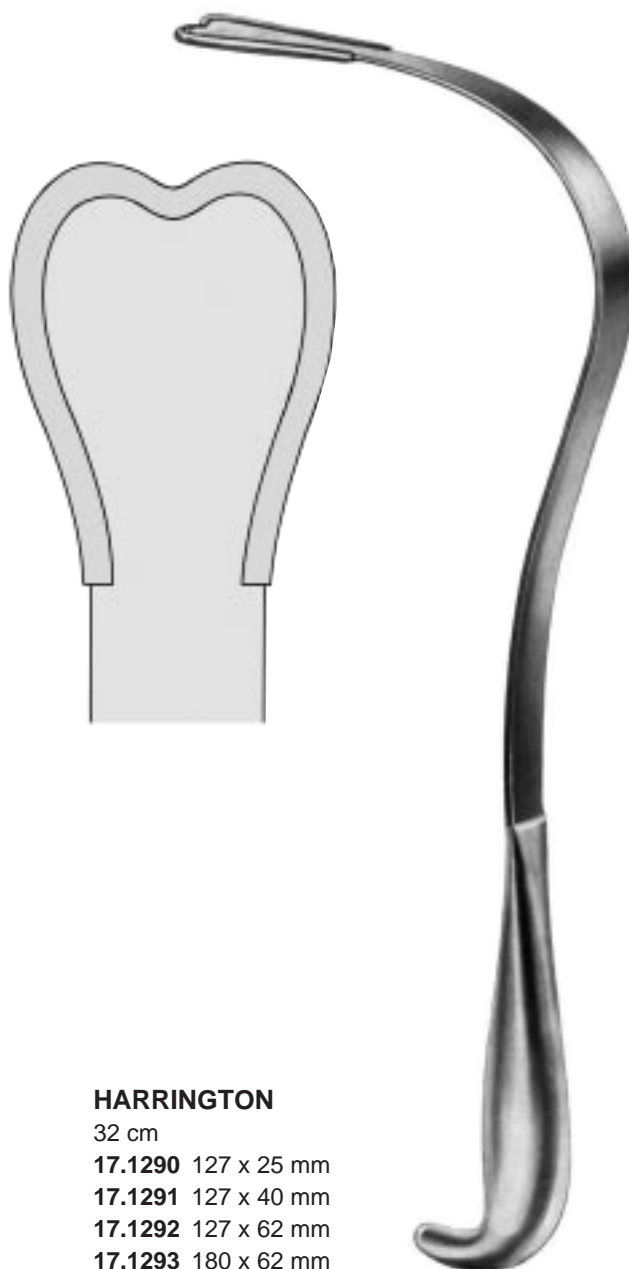

HARRINGTON

32 cm

17.1290 127 x 25 mm

17.1291 127 x 40 mm

17.1292 127 x 62 mm

17.1293 180 x 62 mm



HIBBS

17.1295 25 x 13 mm

17.1296 51 x 20 mm

17.1297 75 x 25 mm

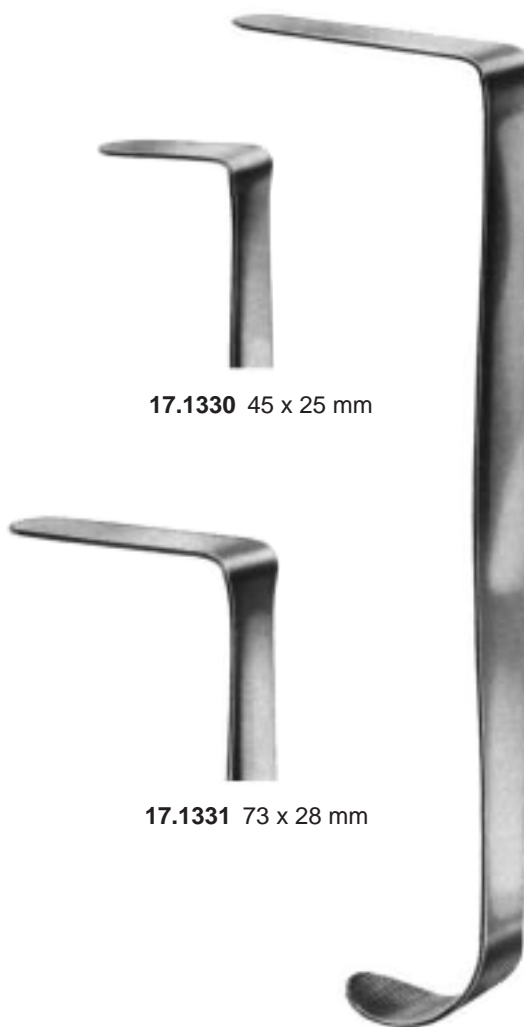

17.1330 45 x 25 mm

17.1331 73 x 28 mm

HEANEY

17.1332 27 cm

82 x 28 mm



ALLISON
17.1302 26 cm / 40 mm



ALLISON
17.1304 30 cm / 45 mm
17.1306 32 cm / 57 mm



ALLISON
17.1310 26 cm / 132 mm



DAVIDSON
17.1320 75 x 50 mm



DAVIDSON
17.1322 75 x 90 mm



POLLOSON
17.1400
27 cm

LUNGENSPATELN
LUNG SPATULAS
SPATULES PULMONAIRES
ESPATULAS PULMONARES
SPATOLE DE PULMONE



POLLOSON
17.1410
27 cm
gefenstert
fenestrated
a jouré
fenestrada
fenestrato

mit Kaltlichtaufsatz und Absaugung
 with F.O. illumination and suction
 avec support lumière froide et aspiration
 con portador de luz fria y aspiración
 con luce fredda e aspirazione



gezhant
 serrated
 dentelé
 dentada
 dentate

17.3000	70 x 16mm
17.3002	70 x 25mm
17.3004	70 x 30mm
17.3006	70 x 36mm
17.3010	80 x 16mm
17.3012	80 x 25mm
17.3014	80 x 30mm
17.3016	80 x 36mm
17.3020	90 x 16mm
17.3022	90 x 25mm
17.3024	90 x 30mm
17.3026	90 x 36mm
17.3030	100 x 16mm
17.3032	100 x 25mm
17.3034	100 x 30mm
17.3036	100 x 36mm
17.3040	150 x 16mm
17.3042	150 x 25mm
17.3044	150 x 30mm
17.3046	150 x 36mm
17.3050	180 x 16mm
17.3052	180 x 25mm
17.3054	180 x 30mm
17.3056	180 x 36mm
17.3060	190 x 16mm
17.3062	190 x 25mm
17.3064	190 x 30mm
17.3066	190 x 36mm

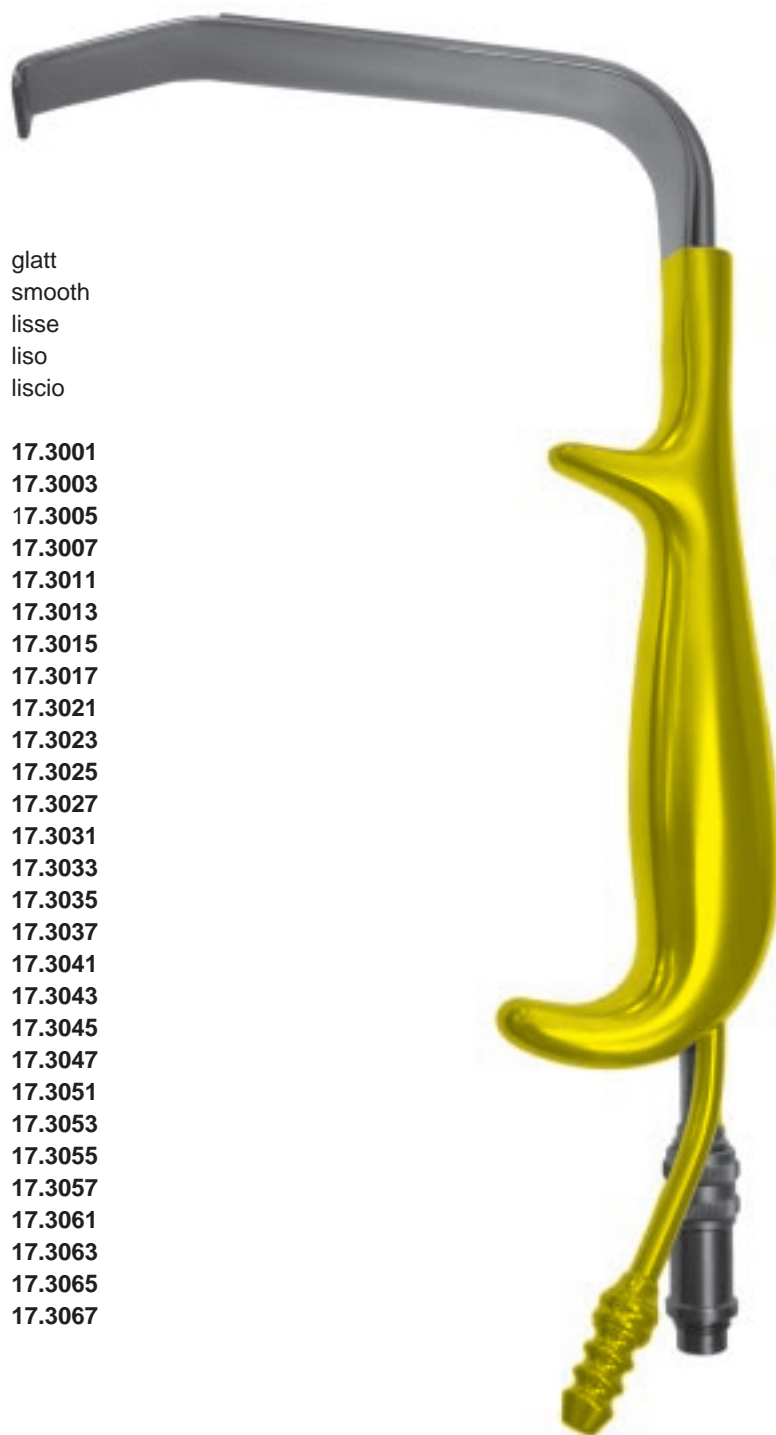

glatt
 smooth
 lisse
 liso
 liscio

17.3001	
17.3003	
17.3005	
17.3007	
17.3011	
17.3013	
17.3015	
17.3017	
17.3021	
17.3023	
17.3025	
17.3027	
17.3031	
17.3033	
17.3035	
17.3037	
17.3041	
17.3043	
17.3045	
17.3047	
17.3051	
17.3053	
17.3055	
17.3057	
17.3061	
17.3063	
17.3065	
17.3067	

SCULPO

KNOCHENHAKEN
BONE HOOKS
CROCHETS PAR OS
GANCHOS PARA HUESOS
GUANCHIO PER OSSI



23.0251 6x10mm



23.0252 11x18mm



23.0253 12x21mm



23 cm



LAMBOTTE
23.0255
27 cm



LANE-TRETHOWAN
23.0330
21,5 cm



LANE
23.0332
25 cm



AUFRANC

- 23.0360** spitz gerieft/sharp serrated/
pointu strié/agudo estriado / acuto con strie
- 23.0361** spitz glatt/sharp smooth/
pointu lisse/agudo liso / acuto liscio
- 23.0362** stumpf gerieft/blunt serrated/
mousse strié/romo estriado / smussa con strie
- 23.0363** stumpf glatt/blunt smooth/
mousse lisse/romo liso / smusso liscio

26 cm / 32 mm

KNIEGELENK-WUNDHAKEN
KNEE RETRACTORS
ECARTEURS POUR GENOU
SEPARADORES PARA RODILLA
DIVARICATORI PER GINOCCHIO



SMILLIE
14 cm

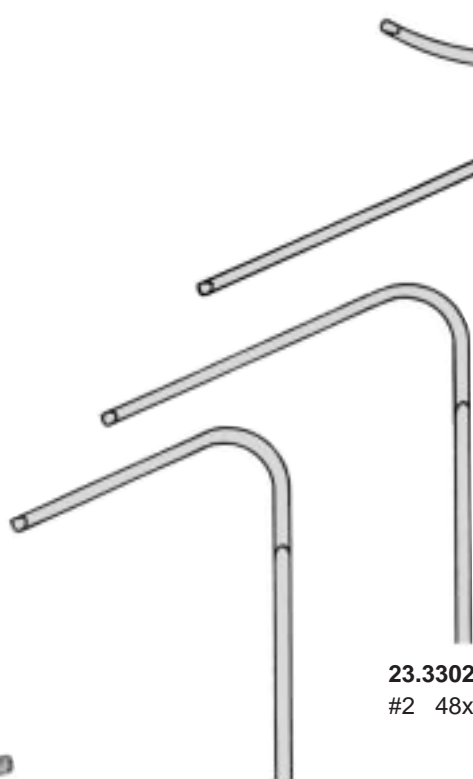

23.3301
#1 32x19 mm

23.3302
#2 48x19 mm

23.3303
#3 57x19 mm

23.3304
#4 52x13 mm

23.3305
#5 17x13 mm



40x4 mm

BLOUNT
23.3310
18 cm



38 x 9 mm

23.3312
21 cm

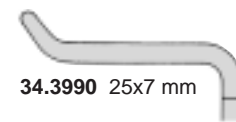
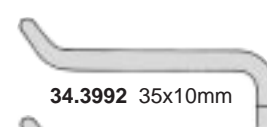
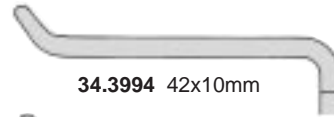
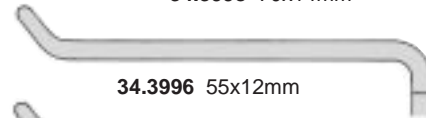
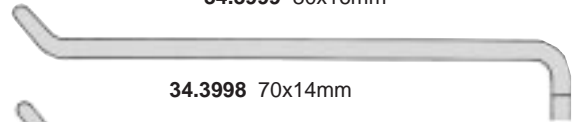
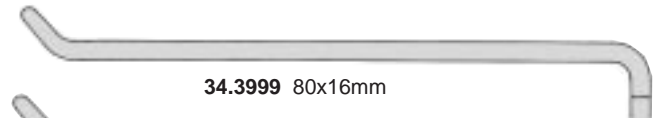
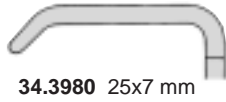
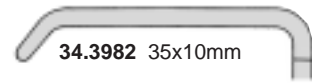
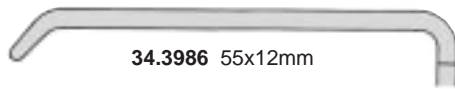
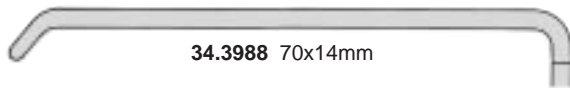
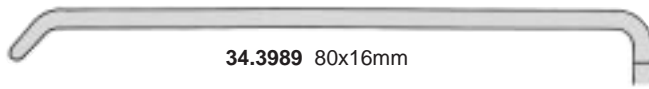

Weichteilehaken
 Soft Tissue Retractors
 Ecarteurs pour parties molles
 Separadores para partes blandas
 Divaricatori per tessuti molli



OBWEGESER
 34.3980-34.3989
 22 cm



OBWEGESER
 34.2990-34.3999
 22 cm

HAKEN FÜR KIEFER- UND GESICHTSCHIRURGIE
RETRACTORS FOR MAXILLO-FACIAL SURGERY
ECARTEURS POUR CHIRURGIE MAXILLO-FACIAL
SEPARADORES PARA CIRUGIA MAXILO-FACIAL
DIVARICATORI PER CHIRURGIA MAXILLO-FACCIALE

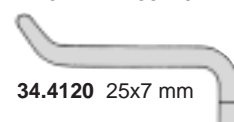
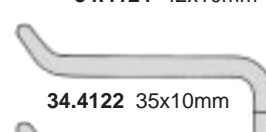
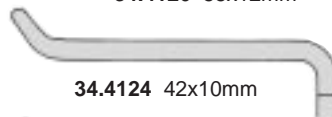
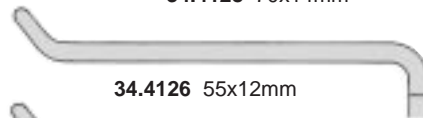
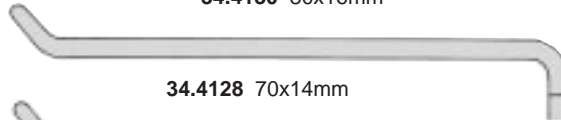
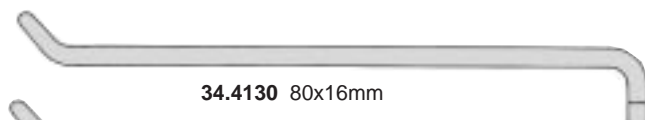
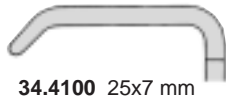
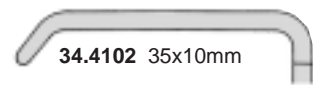
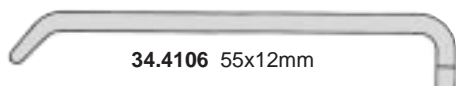
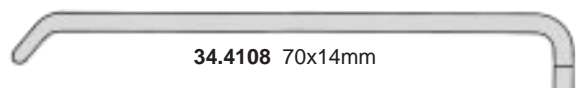
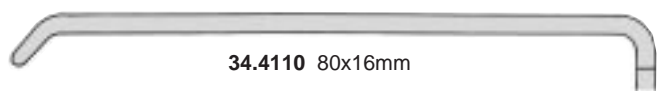

Weichteilhaken
 Soft Tissue Retractors
 Ecarteurs pour parties molles
 Separadores para partes blandas
 Divaricatori per tessuti molli



OBWEGESER
34.4100-34.4110
 22 cm



OBWEGESER
34.4120-34.4130
 22 cm

Wangenhaken
 Cheek Retractors
 Ecarteurs de joues
 Separadores de mejillas
 Divaricatori delle guance



34.0070
19 cm

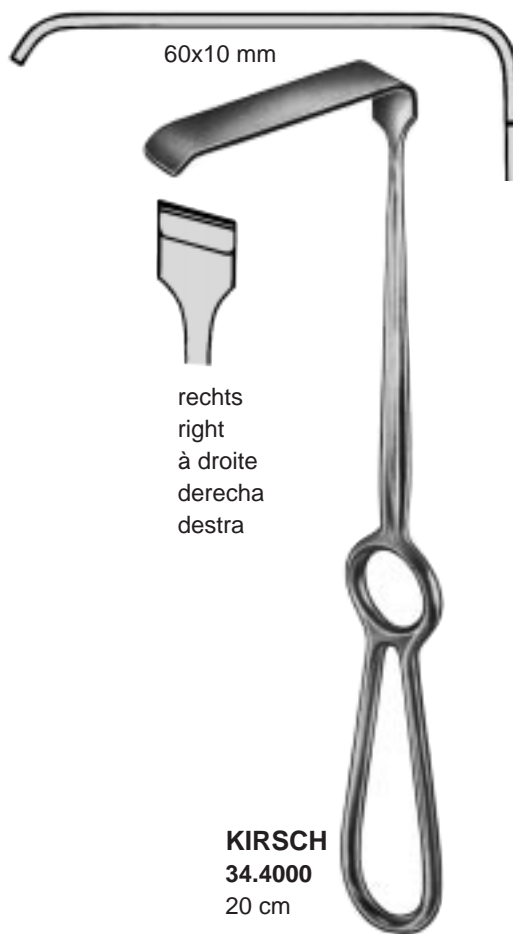

60x10 mm

rechts
right
à droite
derecha
destra

KIRSCH
34.4000
20 cm

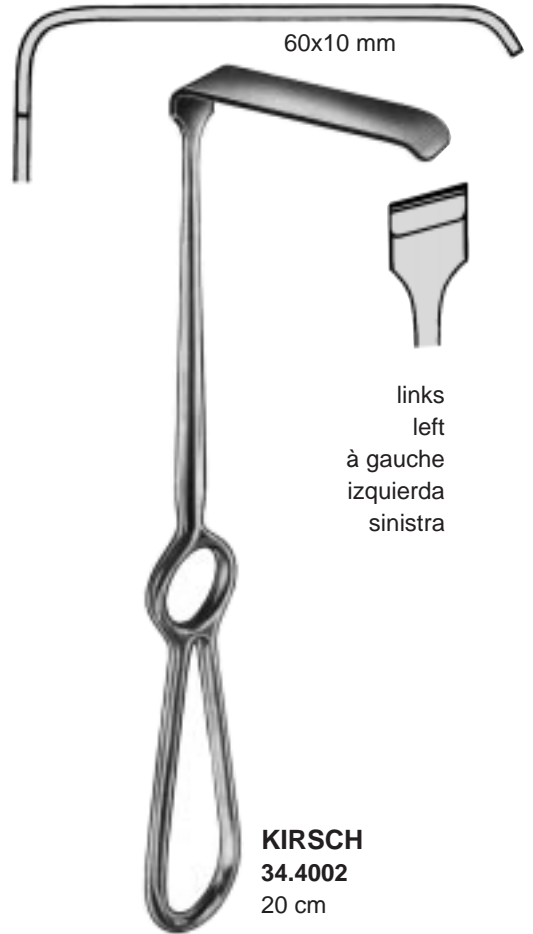

60x10 mm

links
left
à gauche
izquierda
sinistra

KIRSCH
34.4002
20 cm



34.4020
40x12 mm



34.4022
55x14 mm



DOCKHORN
20 cm



STEINHÄUSER
34.4040 24,5 cm



rechts
right
à droite
derecho
destra



links
left
à gauche
izquierdo
sinistra

Zygoma-Wundhaken
 Zygomatic Retractor
 Ecarteur cygomatique
 Separador cigomático
 Divaricatore per zigoma



STEINHÄUSER
34.4042 24,5 cm

HAKEN FÜR KIEFER- UND GESICHTSCHIRURGIE
RETRACTORS FOR MAXILLO-FACIAL SURGERY
ECARTEURS POUR CHIRURGIE MAXILLO-FACIAL
SEPARADORES PARA CIRUGIA MAXILO-FACIAL
DIVARICATORI PER CHIRURGIA MAXILLO-FACCIALE

Ramushaken
Ramus Retractors
Ecarteurs pour ramus
Separadores para el ramo
Separatore per ramo

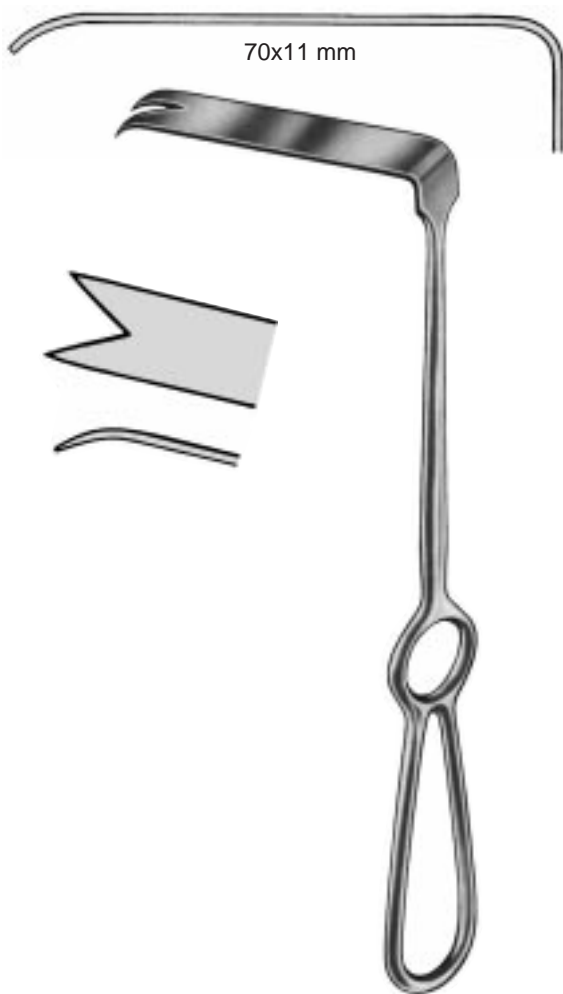

OBWEGESER
34.4140 22 cm

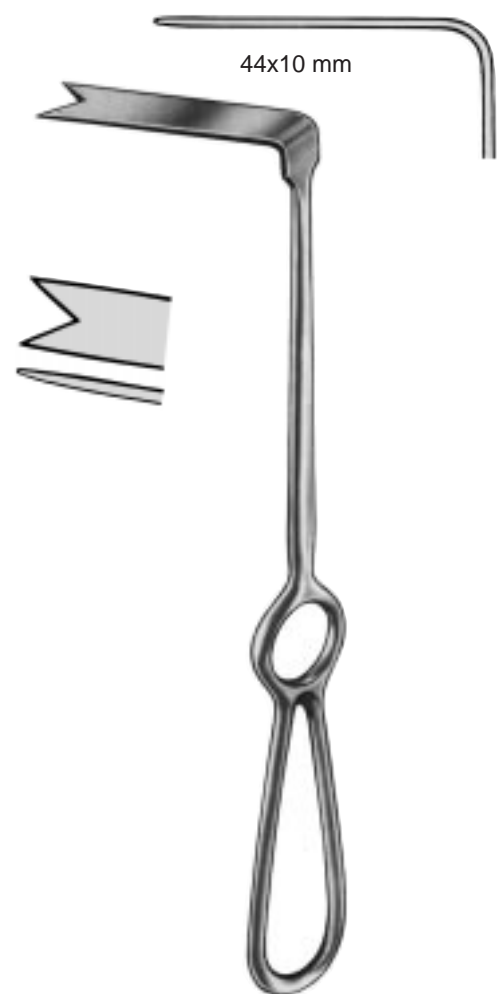

OBWEGESER
34.4145 22 cm

Ramushaken
Ramus Retractors
Ecarteurs pour ramus
Separadores para el ramo
Separatore per ramo



BÜCHS
34.4030
20,5 cm



38x18 mm



11x15x70 mm

OBWEGESER
34.3146 22 cm



34.4150
20 mm



34.4152
25 mm

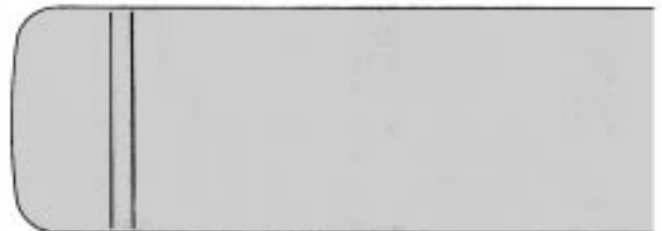

34.4154
30 mm

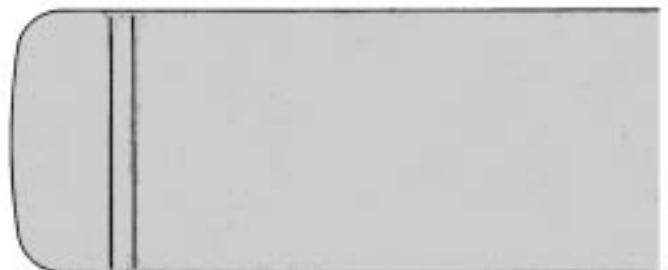

34.4156
35 mm



RAMUS
16 cm

Kinnhalter
Chin Retractor
Fixe-menton
Gancho de mentón
Guancio per mento



OBWEGESER
34.4160
15 cm

Progenierinnen
Channel Retractors
Ecarteurs mandibulaires
Separadores mandibulares
Separatori mandibolari



OBWEGESER
34.4170 8 mm
34.4172 10 mm
16 cm

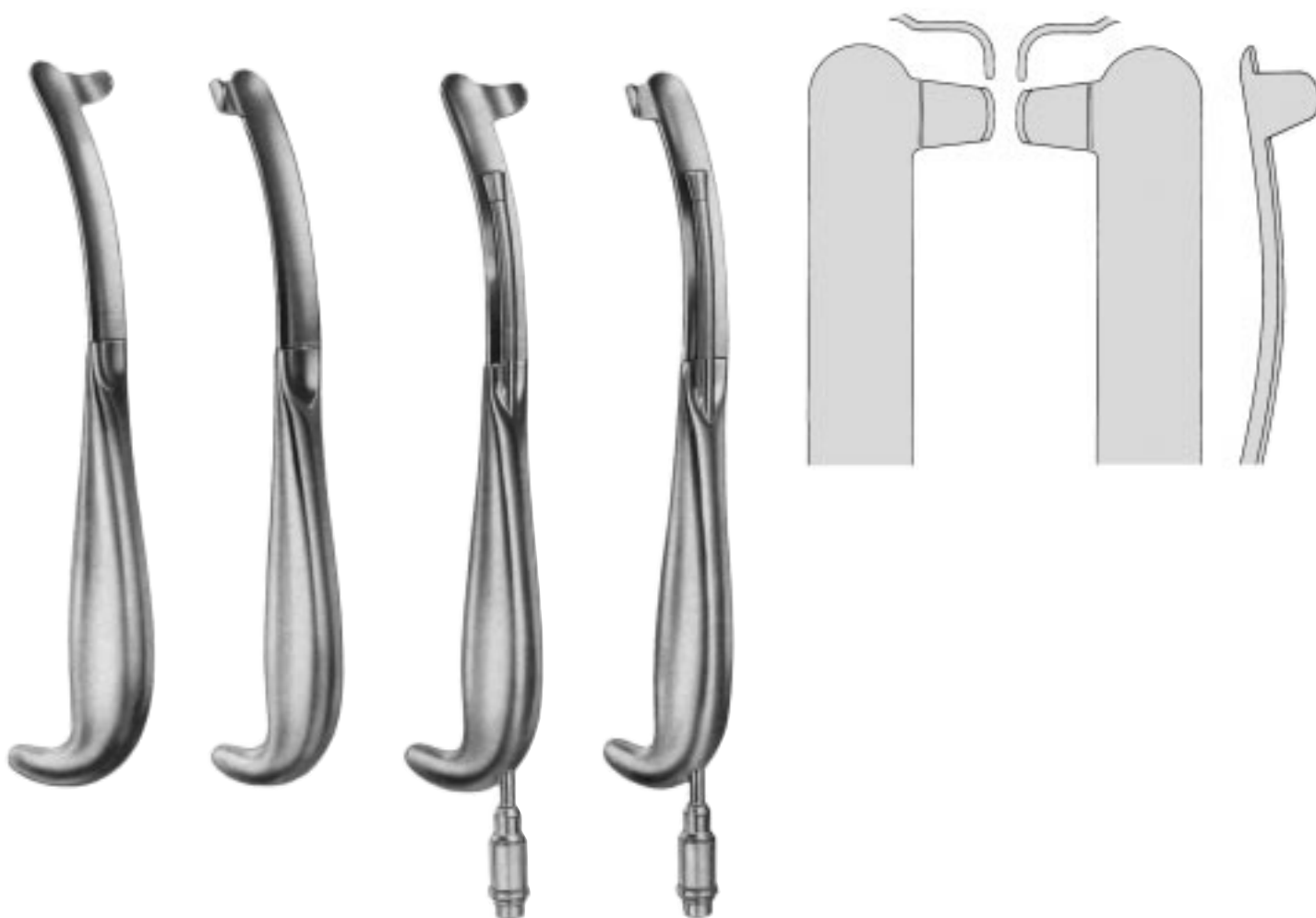

BAUER

34.4200

21 cm
26 / 16 mm
rechts
right
à droite
derecha
destra

BAUER

34.4202

21 cm
26 / 16 mm
links
left
à gauche
izquierda
sinistra

BAUER

34.4205

21 cm
26 / 16 mm
rechts
right
à droite
derecha
destra

BAUER

34.4207

21 cm
26 / 16 mm
links
left
à gauche
izquierda
sinistra

mit Kaltlichtaufsatz / with F.O. illumination /
avec support lumière froide /
con portador de luz fria / con luce fredda



INTRA ORAL
34.4220
24 cm
25 mm



INTRA ORAL
34.4225
24 cm
25 mm

mit Kaltlichtaufsatz
with F.O. illumination
avec support lumière froide
con portador de luz fria
con illuminazione alogena

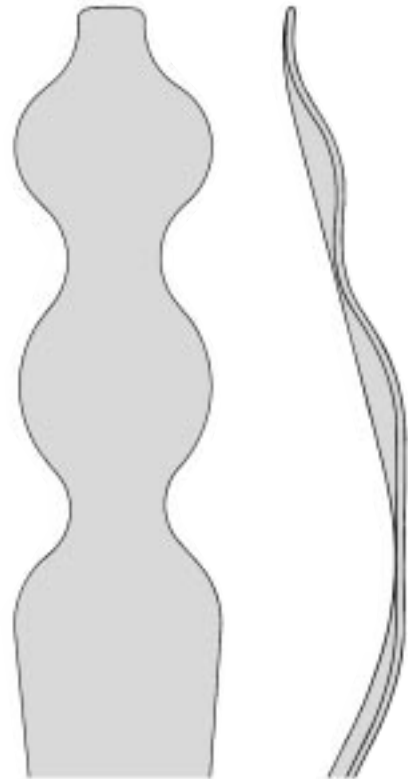



EXTRA ORAL
34.4210
24 cm
9,5 / 16 mm



EXTRA ORAL
34.4215
24 cm
9,5 / 16 mm
mit Kaltlichtaufsatz
with F.O. illumination
avec support lumière froide
con portador de luz fria
con illuminazione alogena

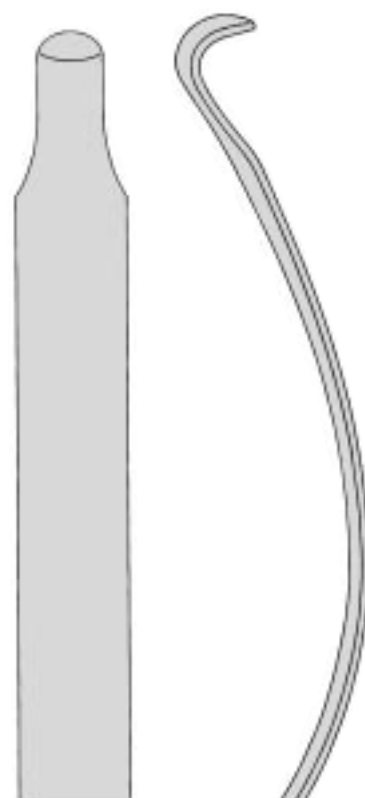

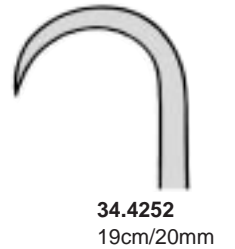
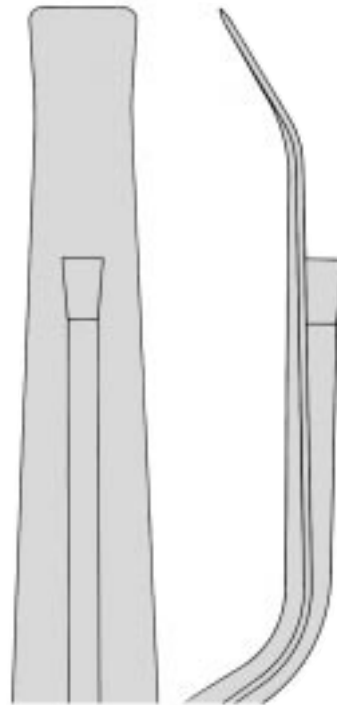
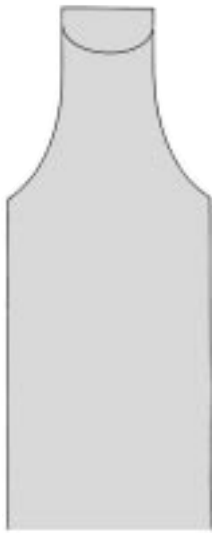

Mehrzweckhaken
 Mult-purpose Retractor
 Ecarteur à usage universelle
 Separador de aplicaciones varias
 Separatore multiuso

LeVASSEUR-MERRILL

34.4260 25 cm
 12,5 / 27 mm

LeVASSEUR-MERRILL

34.4265 25 cm, 12,5 / 27 mm
 mit Kaltlichtaufsatz
 with F.O. illumination
 avec support lumière froide
 con portador de luz fria
 con illuminazione alogena

SHEA

34.4275 24 cm, 14,5 mm
 mit Kaltlichtaufsatz
 with F.O. illumination
 avec support lumière froide
 con portador de luz fria
 con illuminazione alogena

DINGMANN

Zygoma-Haken
 Zygoma Hooks
 Ecarteur zygomatiques
 Ganchos zigomáticos
 Divaricatore per zigoma

AORTA- UND ATRIUMHAKEN
AORTA- AND ATRIUM RETRACTORS
ECARTEURS POUR AORTA ET ATRIUM
SEPARADORES PARA AORTA Y ATRIO
SEPARATORI PER AORTA E ATRIO

Atriumhaken
Atrium Retractors
Ecarteurs pour Atrium
Separadores para atrio
Divaricatori per atrio



BOROWSKI
27 cm



40.0381
17x21 mm



40.0382
16x23 mm



40.0383
20x25 mm



40.0384
24x27 mm



40.0385
28x20 mm



40.0386
28x29 mm

Atriumhaken
Atrium Retractors
Ecarteurs pour Atrium
Separadores para atrio
Divaricatori per atrio



rechts
right
à droite
a derecha
destra

COOLEY
40.0410
21,5 cm



rechts
right
à droite
a derecha
destra

gezahnt
serrated
dentées
dentadas
dentate

COOLEY
40.0411
21,5 cm



links
left
à gauche
a izquierda
sinistra

COOLEY
40.0412
23 cm

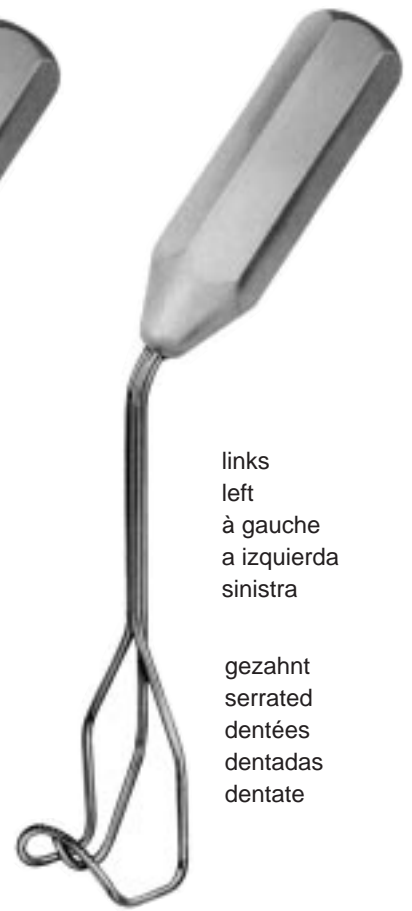

links
left
à gauche
a izquierda
sinistra

gezahnt
serrated
dentées
dentadas
dentate

COOLEY
40.0413
23 cm

AORTA- UND ATRIUMHAKEN
AORTA- AND ATRIUM RETRACTORS
ECARTEURS POUR AORTA ET ATRIUM
SEPARADORES PARA AORTA Y ATRIO
SEPARATORI PER AORTA E ATRIO



CRAWFORD
19 cm

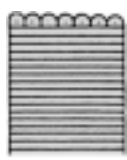

40.0400
15 x 15 mm

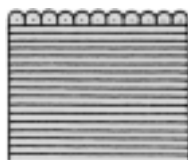

40.0402
15 x 23 mm



ROSS
40.0391-40.0396
27 cm



40.0391
Fig. 1



40.0392
Fig. 2



40.0393
Fig. 3



40.0394
Fig. 4



40.0395
Fig. 5



40.0396
Fig. 6

Aortahaken
Aorta Retractors
Ecarteurs pour Aorta
Separadores para aorta
Divicicatori per aorta
