

WUNDSPREIZER  
RETRACTORS, SELF-RETAINING  
ECARTEURS AUTOSTATIQUES  
SEPARADORES AUTOSTATICOS  
DIVARICATORI AUTOSTATICI

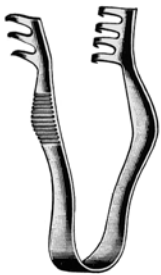





**FINSEN**

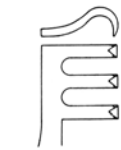

**17.5000** 5 cm  
spitz  
sharp  
pointu  
agudo  
appuntato

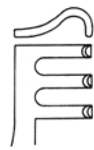

**17.5001** 5 cm  
stumpf  
blunt  
mousse  
romo  
smusso

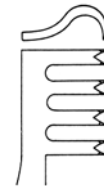

**17.5002** 7 cm  
spitz  
sharp  
pointu  
agudo  
appuntato

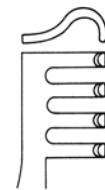

**17.5003** 7 cm  
stumpf  
blunt  
mousse  
romo  
smusso



**FINSEN**

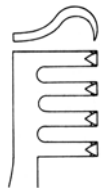

**17.5006** 7 cm  
spitz  
sharp  
pointu  
agudo  
appuntato

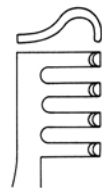

**17.5007** 7 cm  
stumpf  
blunt  
mousse  
romo  
smusso



**WUNDSPREIZER**

**17.5008** 8 cm  
**17.5009** 11 cm



**BOSE**

**36.0120** 7 cm  
Tracheal-Wundspreizer/  
Trachea Retractor/Ecar-  
teur trachéal/Retractor  
traqueal/Divaricatore  
tracheale



**ALM**

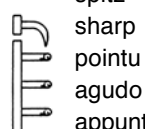

spitz  
sharp  
pointu  
agudo  
appuntato  
**17.5010** 7 cm

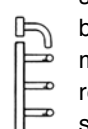

stumpf  
blunt  
mousse  
romo  
smusso  
**17.5011** 7 cm

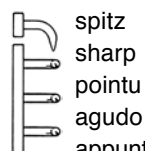

spitz  
sharp  
pointu  
agudo  
appuntato  
**17.5012** 10 cm

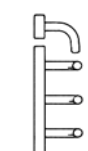

stumpf  
blunt  
mousse  
romo  
smusso  
**17.5013** 10 cm

**WUNDSPREIZER  
RETRACTORS, SELF-RETAINING  
ECARTEURS AUTOSTATIQUES  
SEPARADORES AUTOSTATICOS  
DIVARICATORI AUTOSTATICI**



**ALM**  
**17.5015**  
7 cm / 5,5 mm  
stumpf  
blunt  
mousse  
romo  
smusso



**ALM**  
**17.5017**  
7 cm / 16 mm  
stumpf  
blunt  
mousse  
romo  
smusso



**ALM**  
**17.5019**  
10 cm / 15 mm



**HOLTZHEIMER**  
**17.5020** 10 cm  
scharf/sharp/pointu/  
agudo/appuntato  
**17.5021** 10 cm  
stumpf/blunt/mousse/  
romo/smusso



**EPICARDIAL**  
**17.5030** 0,6N  
**17.5031** 1,2N  
**17.5032** 1,8N

Epicardial Spreizer, 4 cm, stumpf, 8x11 mm,  
25 mm Spreizweite, Gewicht 1 gr., TITAN

Epicardial Spreader 4 cm, blunt, 8x11 mm,  
spread 25 mm, weight 1 gr., TITANIUM

Epicardial Ecarteur, 4 cm, mousse, 8x11 mm,  
ouverture 25 mm, poids 1 gr., TITANE

Epicardial Separadore, 4 cm, romo, 8x11 mm,  
apertura 25 mm, peso 1 gr., TITANIO

Epicardial DIVARICATORE, 4 cm, smusso, 8x11 mm,  
apertura 25 mm, peso 1 gr., TITANIO



**JANSEN**

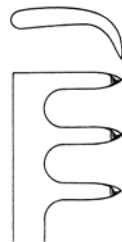

**17.5100** 10.5 cm  
spitz  
sharp  
pointu  
agudo  
appuntato

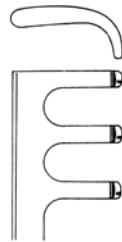

**17.5101** 10.5 cm  
stumpf  
blunt  
mousse  
romo  
smusso



**ALLPORT**  
**17.5150** 10 cm

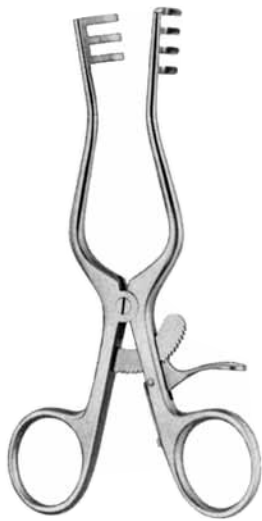

**WEITLANER**

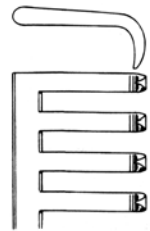

**17.5302** 14 cm  
**17.5304** 16,5 cm

spitz  
 sharp  
 pointu  
 agudo  
 acuto

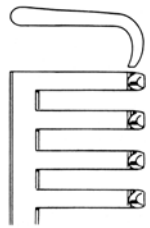

**17.5303** 14 cm  
**17.5305** 16,5 cm

stumpf  
 blunt  
 mousses  
 romo  
 smusso



**WEITLANER**

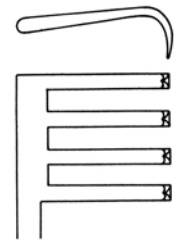

**17.5306** 20 cm

spitz  
 sharp  
 pointu  
 agudo  
 acuto

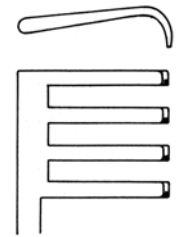

**17.5307** 20 cm

stumpf  
 blunt  
 mousses  
 romo  
 smusso

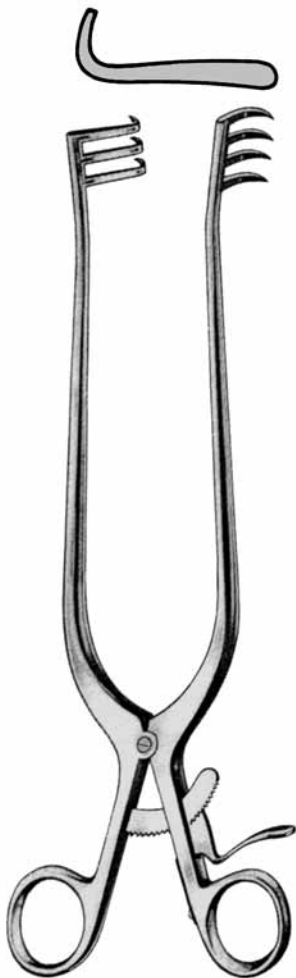

**WEITLANER**  
 24 cm

**17.5308** 3x4 spitz/sharp/pointu/agudo/acuto

**17.5309** 3x4 stumpf/blunt/mousse/romo/smusso

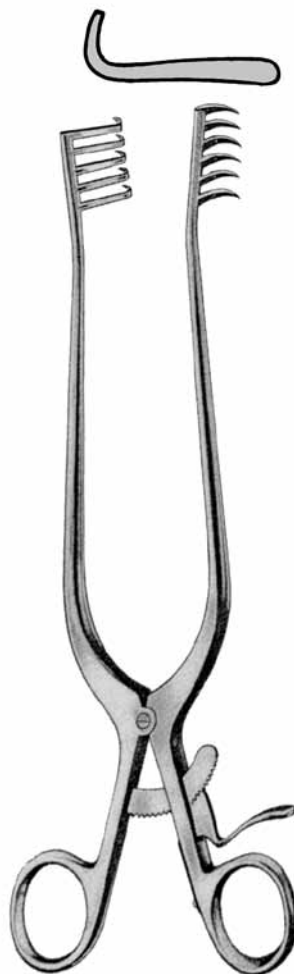

5x6 **17.5310**

5x6 **17.5311**



**ADSON**  
 19 cm

**17.5320** 4x4 spitz/sharp/pointu/agudo/acuto

**17.5321** 4x4 stumpf/blunt/mousse/romo/smusso

**WUNDSPREIZER**  
**SELF-RETAINING RETRACTORS**  
**ECARTEURS AUTOSTATIQUES**  
**SEPARADORES AUTOSTATICOS**  
**DIVARICATORI AUTOSTATICI**



**ADSON**  
 26,5 cm

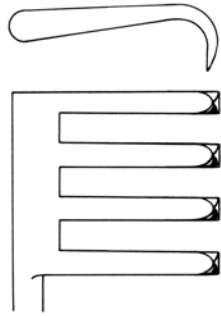

3x4  
 spitz  
 sharp  
 pointu  
 agudo  
 acuto

17.5322

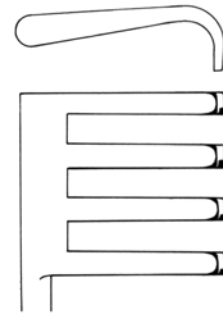

3x4  
 stumpf  
 blunt  
 mousses  
 romo  
 smusso

17.5323

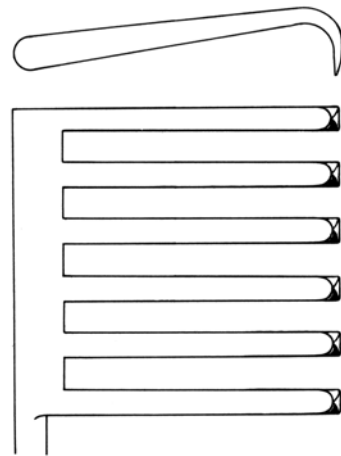

6x6  
 spitz  
 sharp  
 pointu  
 agudo  
 acuto

17.5324

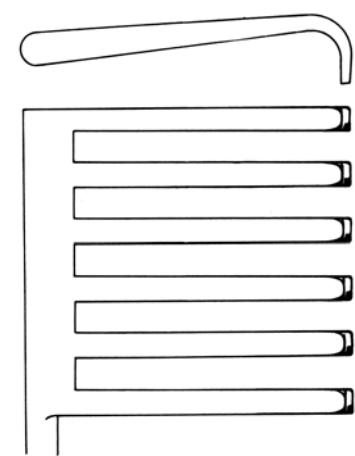

6x6  
 stumpf  
 blunt  
 mousses  
 romo  
 smusso

17.5325

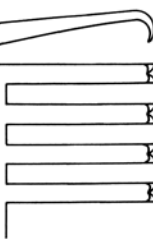

**17.5330**  
 spitz/sharp/pointu/agudo/acuto

**17.5331**  
 stumpf/blunt/mousse/romo/smusso

**ANDERSON-ADSON**  
 20 cm

spitz  
 sharp  
 pointu  
 agudo  
 acuto

stumpf  
 blunt  
 mousses  
 romo  
 smusso

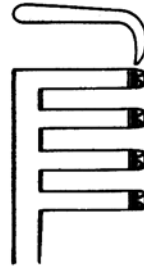

**17.5600**  
 14 cm

**17.5601**  
 14 cm

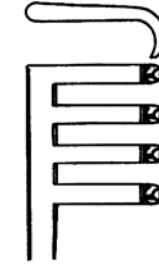
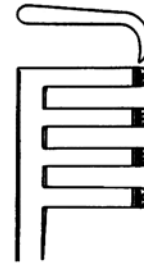

**17.5602**  
 16,5 cm

**17.5603**  
 16,5 cm

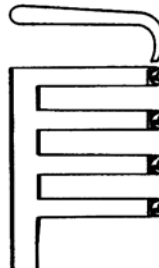
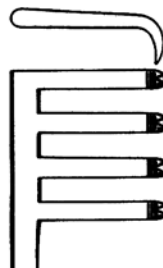

**17.5604**  
 20 cm

**17.5605**  
 20 cm

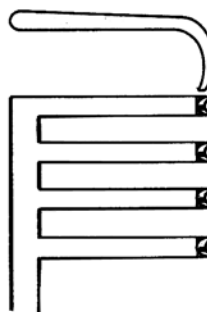
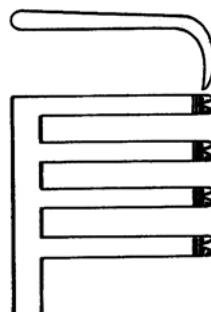

**17.5606**  
 26 cm

**17.5607**  
 26 cm

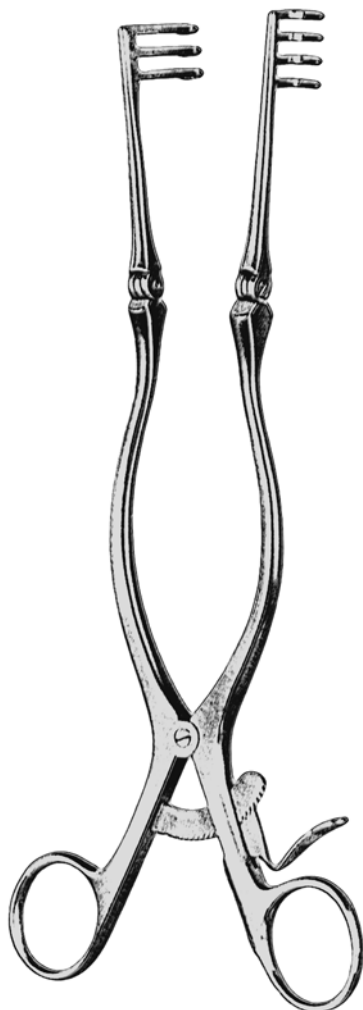

**BECKMANN-WEITLANER  
 (ADSON, CONE)**

**WUNDSPREIZER  
SELF-RETAINING RETRACTORS  
ECARTEURS AUTOSTATIQUES  
SEPARADORES AUTOSTATICOS  
DIVARICATORI AUTOSTATICI**

spitz  
sharp  
pointu  
agudo  
acuto

7x7  
spitz  
sharp  
pointu  
agudo  
acuto



**BECKMANN**  
17.5610 31 cm



**BECKMANN-EATON**  
17.5620 32 cm



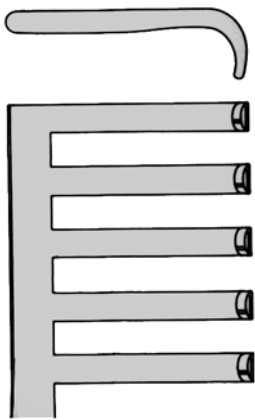

4x5  
 stumpf  
 blunt  
 mousses  
 romo  
 smusso

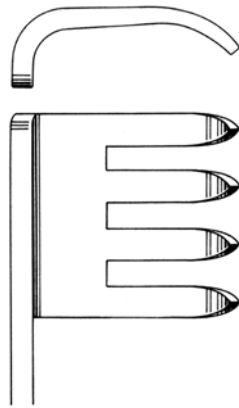

spitz  
 sharp  
 pointu  
 agudo  
 acuto

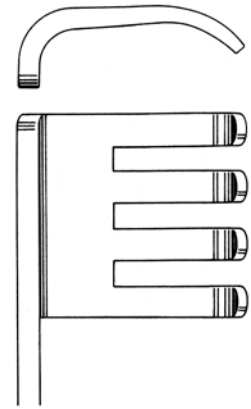

stumpf  
 blunt  
 mousses  
 romo  
 smusso

17.5635 25 mm

17.5636 25 mm



**ADSON**  
 17.5632 32 cm



**BECKMANN-ADSON**  
 31 cm

spitz  
 sharp  
 pointu  
 agudo  
 acuto

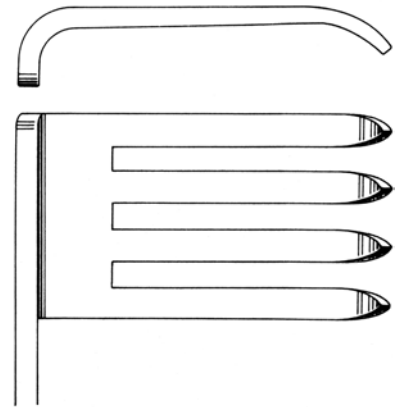

17.5637 44 mm

stumpf  
 blunt  
 mousses  
 romo  
 smusso

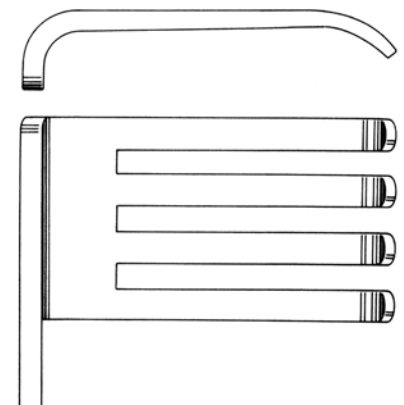

17.5638 44 mm

WUNDSPREIZER  
 SELF-RETAINING RETRACTORS  
 ECARTEURS AUTOSTATIQUES  
 SEPARADORES AUTOSTATICOS  
 DIVARICATORI AUTOSTATICI



**TUEBINGEN**  
 17.5910 16,5 cm

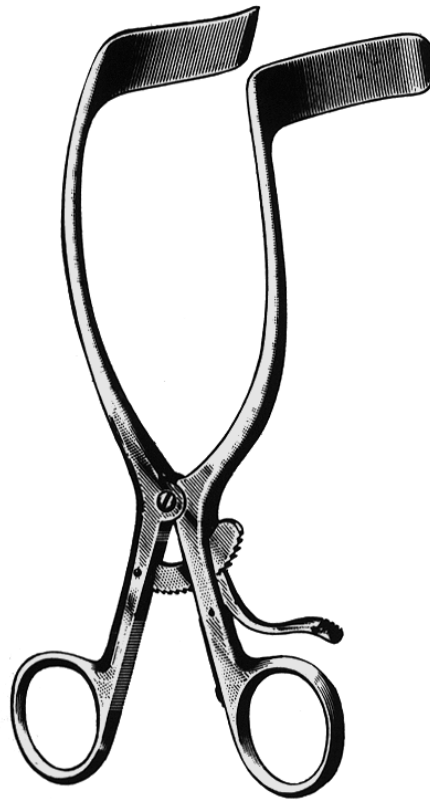

**RIGBY**  
 17.5930 18 cm  
 60 x 20 mm

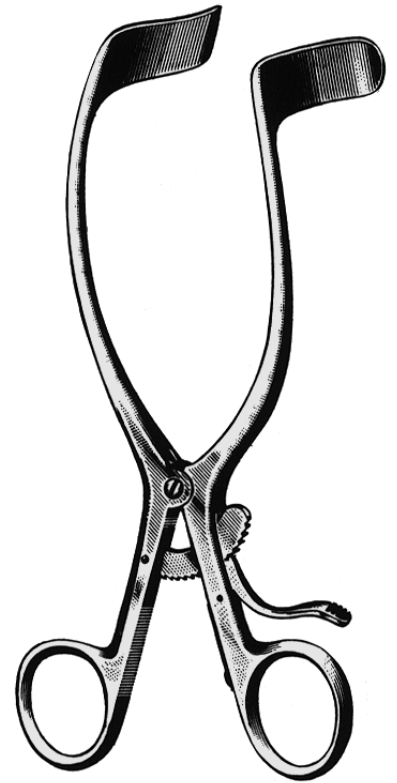

**RIGBY**  
 17.5932 18 cm  
 35 x 20 mm



**HENLEY**  
 16,5 cm  
 mit Mittelvalven  
 with center blades  
 avec valves centrales  
 con valvas centrales  
 con valve centrale

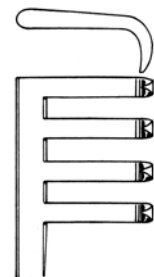

17.5980

spitz  
 sharp  
 pointy  
 agudo  
 acuto

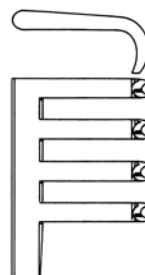

17.5982

stumpf  
 blunt  
 mousse  
 romo  
 smusso

- 17.5985 - 17.5987
- 17.5985 - 17.5987
- 17.5985 - 17.5987
- 17.5985 - 17.5987
- 17.5985 - 17.5987



**HENLEY**

- 17.5985 16 x 20 mm
- 17.5986 16 x 25 mm
- 17.5987 16 x 30 mm

17.5988 16 x 76 mm  
 (nicht abgebildet / not illustrated /  
 non illustré / sin ilustración / senza  
 illustrazione)

für Peripheral-Chirurgie/  
 Improved Model for peripheral  
 vascular surgery/  
 pour la chirurgie vasculaire  
 périphérique/  
 para cirugía periferal/  
 per chirurgia vascolare periferiale



**HENLEY**  
17.5990 18 cm

Wundspreizer komplett bestehend aus:

- 17.5991 1 Sperrer
- 17.5992 1 Paar stumpfe Seitenvalven 25 x 23 mm
- 17.5993 1 Paar stumpfe Seitenvalven 50 x 23 mm
- 17.5994 1 Paar stumpfe Seitenvalven 75 x 23 mm
- 17.5985 1 gezahnte Mittelvalve 16 x 20 mm
- 17.5986 1 gezahnte Mittelvalve 16 x 25 mm
- 17.5987 1 gezahnte Mittelvalve 16 x 30 mm

Retractor complete consisting of:

- 17.5991 1 Spreader
- 17.5992 1 Pair lateral valves, blunt 25 x 23 mm
- 17.5993 1 Pair lateral valves, blunt 50 x 23 mm
- 17.5994 1 Pair lateral valves, blunt 75 x 23 mm
- 17.5985 1 central valve, serrated 16 x 20 mm
- 17.5986 1 central valve, serrated 16 x 25 mm
- 17.5987 1 central valve, serrated 16 x 30 mm

Ecarteur complet comprenant:

- 17.5991 1 Ecarteur
- 17.5992 1 Paire de valves latérales, mouses 25 x 23 mm
- 17.5993 1 Paire de valves latérales, mouses 50 x 23 mm
- 17.5994 1 Paire de valves latérales, mouses 75 x 23 mm
- 17.5985 1 Valve centrale, dentelée 16 x 20 mm
- 17.5986 1 Valve centrale, dentelée 16 x 25 mm
- 17.5987 1 Valve centrale, dentelée 16 x 30 mm

Separador completo compuesto de:

- 17.5991 1 Separador
- 17.5992 1 Par de valvas laterales, romas, 25 x 23 mm
- 17.5993 1 Par de valvas laterales, romas, 50 x 23 mm
- 17.5994 1 Par de valvas laterales, romas, 75 x 23 mm
- 17.5985 1 Valva central dentada 16 x 20 mm
- 17.5986 1 Valva central dentada 16 x 25 mm
- 17.5987 1 Valva central dentada 16 x 30 mm

Divaricatore completo composta da:

- 17.5991 1 Divaricatore
- 17.5992 1 Paio di valve laterali, smusse 25 x 23 mm
- 17.5993 1 Paio di valve laterali, smusse 50 x 23 mm
- 17.5994 1 Paio di valve laterali, smusse 75 x 23 mm
- 17.5985 1 Valva centrale dentellata 16 x 20 mm
- 17.5986 1 Valva centrale dentellata 16 x 25 mm
- 17.5987 1 Valva centrale dentellata 16 x 30 mm



**HENLEY**  
17.5991 18 cm



**HENLEY**  
17.5992  
25x23 mm



**HENLEY**  
17.5993  
50x23 mm

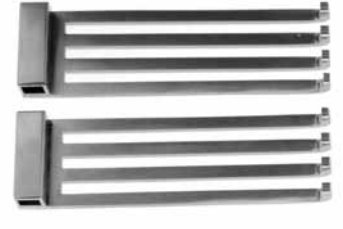

**HENLEY**  
17.5994  
75x23 mm

**WUNDSPREIZER  
SELF-RETAINING RETRACTORS  
ECARTEURS AUTOSTATIQUES  
SEPARADORES AUTOSTATICOS  
DIVARICATORI AUTOSTATICI**



**KÖLBEL**  
17.6050 20 cm

Wundspreizer komplett bestehend aus:

- 17.6051 1 Sperrer
- 17.6052 1 Paar Valven 36 x 36 mm
- 17.6053 1 Paar Valven 53 x 36 mm
- 17.6054 1 Paar Valven 68 x 36 mm

Retractor complete consisting of:

- 17.6051 1 Spreader
- 17.6052 1 pair valves 36 x 36 mm
- 17.6053 1 pair valves 53 x 36 mm
- 17.6054 1 pair valves 68 x 36 mm

Ecarteur complet comprenant:

- 17.6051 1 Ecarteur
- 17.6052 1 Paire de valves 36 x 36 mm
- 17.6053 1 Paire de valves 53 x 36 mm
- 17.6054 1 Paire de valves 68 x 36 mm

Separador completo compuesto de:

- 17.6051 1 Separador
- 17.6052 1 Par de valvas 36 x 36 mm
- 17.6053 1 Par de valvas 53 x 36 mm
- 17.6054 1 Par de valvas 68 x 36 mm

Divaricatore completo composta da:

- 17.6051 1 Divaricatore
- 17.6052 1 Paio di valve 36 x 36 mm
- 17.6053 1 Paio di valve 53 x 36 mm
- 17.6054 1 Paio di valve 68 x 36 mm



**KÖLBEL**  
17.6051 20 cm



**17.6052**  
36 x 36 mm



**17.6053**  
53 x 36 mm



**17.6054**  
68 x 36 mm