

WUNDSPEIZER
RETRACTORS, SELF-RETAINING
ECARTEURS AUTOSTATIQUES
SEPARADORES AUTOSTATICOS
DIVARICATORI AUTOSTATICI

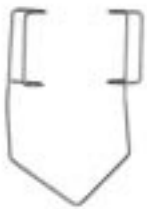

MIKRO- UND LIDSPERRER
 MICRO RETRACTORS, EYE SPECULA
 MICRO ECARTEURS, BLEPHAROSTATS
 MICRO-SEPARADORES AUTOSTATICOS, BLEFAROSTATOS
 MICRO DIVARICATORI OFTALMICI



BARRAQUER
30.0003
 30 mm
 Kinder
 children
 enfants
 niños
 bambini

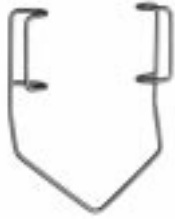

BARRAQUER
30.0004
 40 mm
 Erwachsene
 adults
 adultes
 adultos
 adulti



BARRAQUER
30.0005
 40 mm



BOWMAN
30.0007
 7 cm



30.0008
 5 cm
 Öffnung 35 mm
 opening 35 mm
 ouverture 35 mm
 apertura 35 mm
 apertura 35 mm



SMITH
30.0010
 5 cm



CRITCHETT
30.0020
 6 cm



CLARKE
30.0030
 8 cm



GRAEFE
30.0040 6 cm
30.0042 9 cm



WEISS
30.0050
 8 cm



SAUER
30.0060
 6 cm



ARRUGA
30.0070
 7 cm



ARRUGA
30.0072
 7 cm



MURDOCK
30.0076
 5 cm



**MELLINGER-
 AXENFELD**
 30.0080
 7 cm



**MELLINGER-
 AXENFELD**
 30.0082
 7 cm



MELLINGER
 30.0084 5 cm
 Kinder/children
 enfants /niños/bambini
 30.0085 7 cm
 Erwachsene/adults
 adultes/adultos/adulti



LISTER-BURCH
 30.0090
 8 cm



WILLIAMS
 30.0094 7 cm
 30.0095 8 cm



LANCASTER
 30.0100
 7 cm



ZIEGLER
 30.0110
 7 cm



PLEY
 30.0115
 6 cm



CASTROVIEJO
 30.0120
 8 cm



PARK
 30.0130
 8 cm



PARK-GUYTON
 30.0135
 8 cm



PARK-MAUMENEE
 30.0136
 8 cm



MUELLER
 30.0140
 7 cm



STEVENSON
 30.0150
 7 cm



GOLDSTEIN
30.0160
 3 cm



GOLDSTEIN-MINI
30.0162
 3 cm



AGRICOLA
30.0170



COOK
30.0181 3 cm
 Kinder/children
 enfants /niños/bambini
30.0182 5 cm
 Erwachsene/adults
 adultes/adultos/adulti



LIEBERMANN
30.0190 8 cm
 "K"-form/"K"-shaped/
 forme "K"/forma "K"/
 forma "K"



LIEBERMANN
30.0191 8 cm
 "V"-form/"v"-shaped/
 forme "V"/forma "V"/
 forma "V"



LIEBERMANN
30.0192 8 cm
 Kinder/children/
 enfants /niños/bambini



LIEBERMANN
30.0193 8 cm
 Erwachsene/adults/
 adultes/adultos/adulti



FINSEN



17.5000 5 cm
 spitz
 sharp
 pointu
 agudo
 appuntato



17.5001 5 cm
 stumpf
 blunt
 mousse
 romo
 smusso

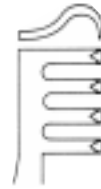

17.5002 7 cm
 spitz
 sharp
 pointu
 agudo
 appuntato



17.5003 7 cm
 stumpf
 blunt
 mousse
 romo
 smusso



FINSEN



17.5006 7 cm
 spitz
 sharp
 pointu
 agudo
 appuntato



17.5007 7 cm
 stumpf
 blunt
 mousse
 romo
 smusso



WUNDSPREIZER

17.5008 8 cm
17.5009 11 cm



BOSE

36.0120 7 cm
 Tracheal-Wundsperrzer/
 Trachea Retractor/
 Ecarteur trachéal/
 Retractor traqueal/
 Divaricatore tracheale



ALM



spitz
 sharp
 pointu
 agudo
 appuntato
17.5010 7 cm



stumpf
 blunt
 mousse
 romo
 smusso
17.5011 7 cm



spitz
 sharp
 pointu
 agudo
 appuntato
17.5012 10 cm



stumpf
 blunt
 mousse
 romo
 smusso
17.5013 10 cm

WUNDSPERRER
 SELF-RETAINING RETRACTORS
 ECARTEURS AUTOSTATIQUES
 SEPARADORES AUTOSTATICOS
 DIVARICATORI AUTOSTATICI



ALM
17.5015
 7 cm / 5,5 mm
 stumpf
 blunt
 mousse
 romo
 smusso



ALM
17.5017
 7 cm / 16 mm
 stumpf
 blunt
 mousse
 romo
 smusso



ALM
17.5019
 10 cm / 15 mm



HOLTZHEIMER
17.5020 10 cm
 scharf/sharp/pointu/
 agudo/appuntato
17.5021 10 cm
 stumpf/blunt/mousse/
 romo/smusso



EPICARDIAL
17.5030 0,6N
17.5031 1,2N
17.5032 1,8N

Epicardial Spreizer, 4 cm, stumpf, 8x11 mm,
 25 mm Spreizweite, Gewicht 1 gr., TITAN

Epicardial Spreader 4 cm, blunt, 8x11 mm,
 spread 25 mm, weight 1 gr., TITANIUM

Epicardial Ecarteur, 4 cm, mousse, 8x11 mm,
 ouverture 25 mm, poids 1 gr., TITANE

Epicardial Separadore, 4 cm, romo, 8x11 mm,
 apertura 25 mm, peso 1 gr., TITANIO

Epicardial DIVARICATORE, 4 cm, smusso, 8x11 mm,
 apertura 25 mm, peso 1 gr., TITANIO



JANSEN

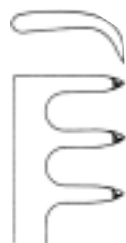

17.5100 10.5 cm
 spitz
 sharp
 pointu
 agudo
 appuntato

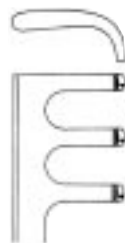

17.5101 10.5 cm
 stumpf
 blunt
 mousse
 romo
 smusso



ALLPORT
17.5150 10 cm

gerieftete Valven
 Serrated blades
 valves striées
 valvas estriadas
 Valva con striatura

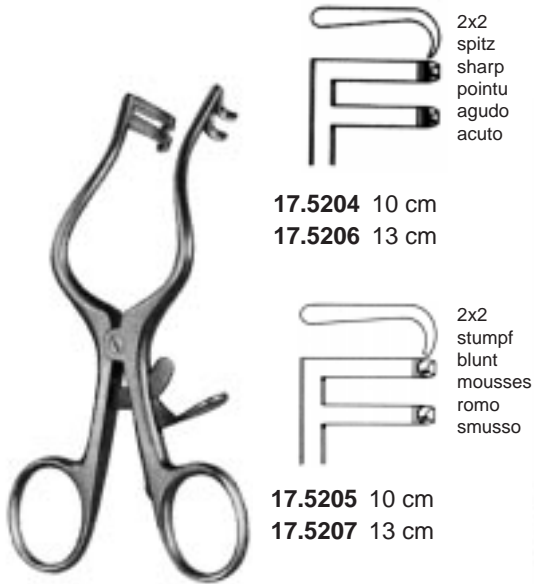

17.5204 10 cm
 17.5206 13 cm

2x2
 spitz
 sharp
 pointu
 agudo
 acuto

2x2
 stumpf
 blunt
 mousset
 romo
 smusso

17.5205 10 cm
 17.5207 13 cm

PLESTER



COX
 17.5210
 12 cm

für Finger und Zehen
 Finger- and Toe Retractor
 pour doigts et orteils
 para dedos
 per dita e piede

SCALP-CONTOUR
 14 cm

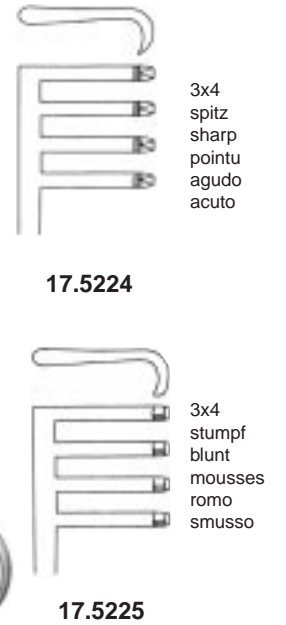

17.5224

3x4
 spitz
 sharp
 pointu
 agudo
 acuto

3x4
 stumpf
 blunt
 mousset
 romo
 smusso

17.5225

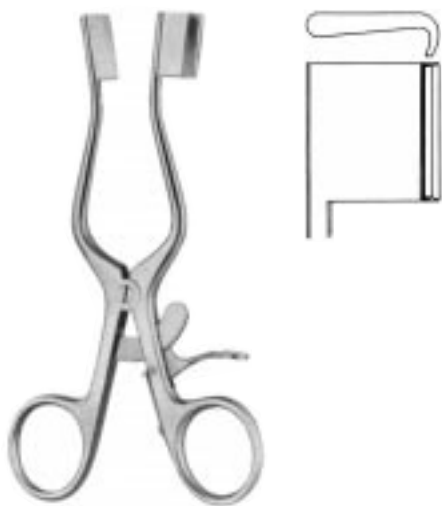

WEITLANER-BABY
 17.5290 14 cm



WEITLANER
 10,5 cm

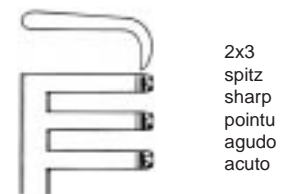

17.5300

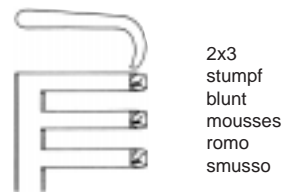

17.5301

2x3
 spitz
 sharp
 pointu
 agudo
 acuto

2x3
 stumpf
 blunt
 mousset
 romo
 smusso

WUNDSPREIZER
 SELF-RETAINING RETRACTORS
 ECARTEURS AUTOSTATIQUES
 SEPARADORES AUTOSTATICOS
 DIVARICATORI AUTOSTATICI



WEITLANER



spitz
sharp
pointu
agudo
acuto

17.5302 14 cm
 17.5304 16,5 cm



stumpf
blunt
mousses
romo
smusso

17.5303 14 cm
 17.5305 16,5 cm



WEITLANER



spitz
sharp
pointu
agudo
acuto

17.5306 20 cm

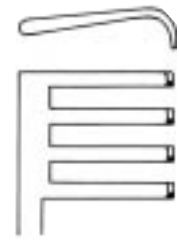

stumpf
blunt
mousses
romo
smusso

17.5307 20 cm



WEITLANER
24 cm

17.5308 3x4 spitz/sharp/pointu/agudo/acuto 5x6 17.5310
 17.5309 3x4 stumpf/blunt/mousse/romo/smusso 5x6 17.5311



ADSON
19 cm

17.5320 4x4 spitz/sharp/pointu/agudo/acuto
 17.5321 4x4 stumpf/blunt/mousse/romo/smusso



ADSON
 26,5 cm

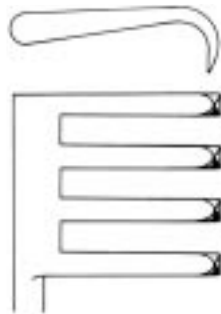

3x4
 spitz
 sharp
 pointu
 agudo
 acuto

17.5322

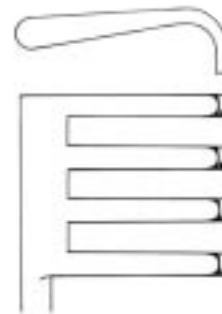

3x4
 stumpf
 blunt
 mousses
 romo
 smusso

17.5323

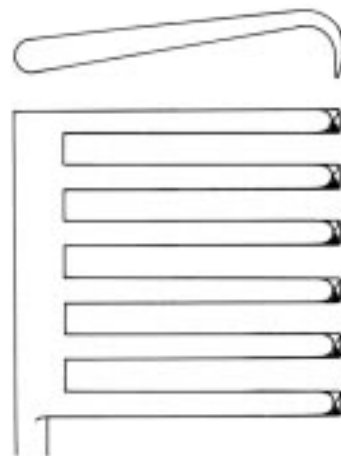

6x6
 spitz
 sharp
 pointu
 agudo
 acuto

17.5324

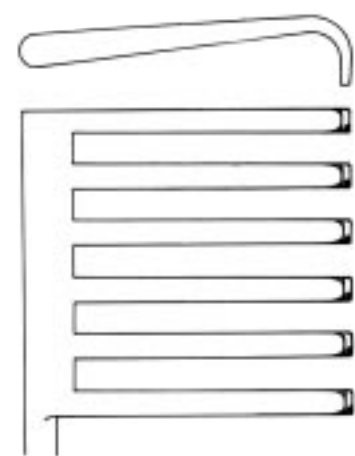

6x6
 stumpf
 blunt
 mousses
 romo
 smusso

17.5325

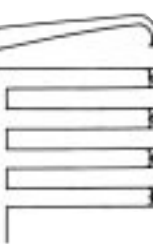

17.5330
 spitz/sharp/pointu/agudo/acuto

17.5331
 stumpf/blunt/mousse/romo/smusso

ANDERSON-ADSON
 20 cm



HEMILAMINEKTOMIE
28 cm

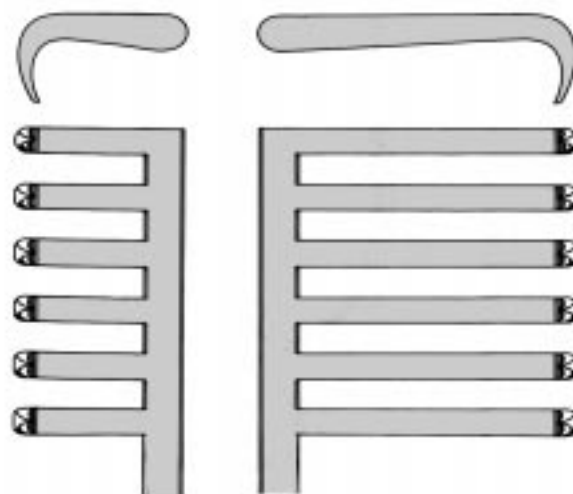

17.5328

spitz, lange Zähne links
sharp, long teeth on right side
pointu, griffes longues à droite
agudo, dientes largos a la derecha
acuto, denti lunghi a sinistra

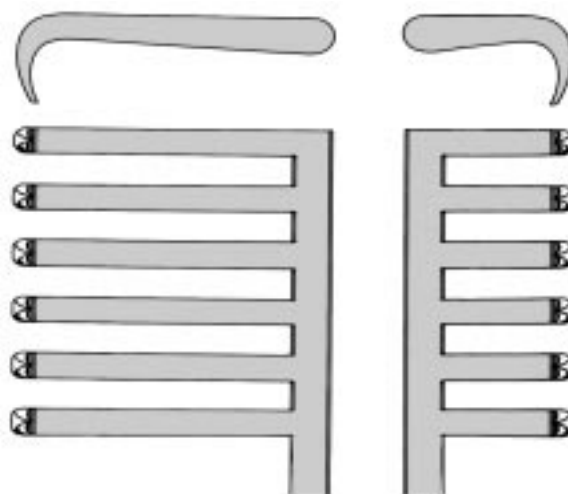

17.5329

32x14 mm
spitz, lange Zähne links
sharp, long teeth on left
pointu, griffes longues à gauche
agudo, dientes largos a la izquierda
acuto, denti lunghi a destra



CONE

25 cm

17.5332

spitz/sharp/pointu/agudo/acuto

17.5333

stumpf/blunt/mousse/romo/smusso



TRAVERS

20cm

17.5336

4x5 stumpf/blunt/mousse/romo/smusso



NORFOLK-NORWICH

17.5340

20 cm

WUNDSPREIZER
SELF-RETAINING RETRACTORS
ECARTEURS AUTOSTATIQUES
SEPARADORES AUTOSTATICOS
DIVARICATORI AUTOSTATICI



WALTON
 17.5350 18 cm



WALTON
 17.5351 18 cm



WULLSTEIN



spitz
 sharp
 pointu
 agudo
 acuto

- 17.5400 10,5 cm
- 17.5402 13,0 cm
- 17.5404 16,0 cm



stumpf
 blunt
 mousses
 romo
 smusso

- 17.5401 10,5 cm
- 17.5403 13,0 cm
- 17.5405 16,0 cm



MOLLISON
 17.5406
 15 cm



MILLIGAN
 17.5410
 13 cm





SCHUKNECHT
17.5416
13 cm



PLESTER-R
17.5450
10,5 cm



PLESTER-L
17.5451
10,5 cm



PERKINS-R
17.5446
13 cm

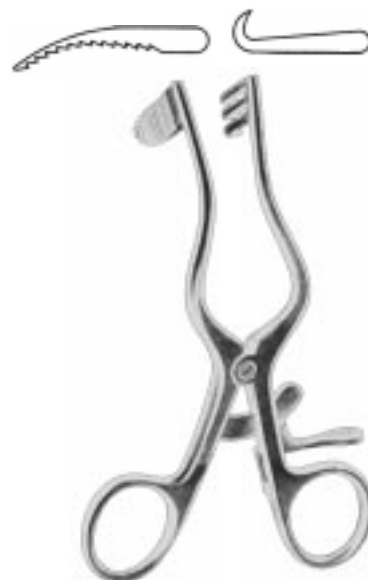

PERKINS-L
17.5447
13 cm

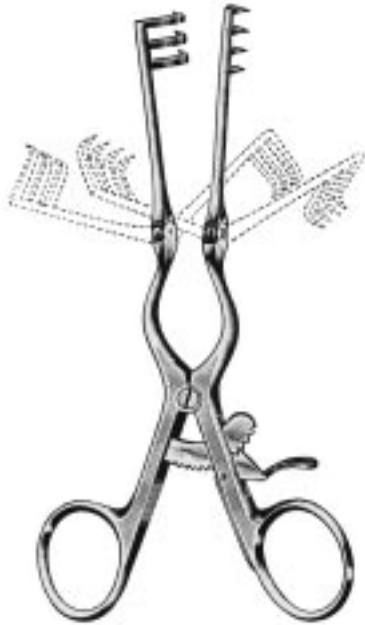

ADSON-BABY
 16 cm

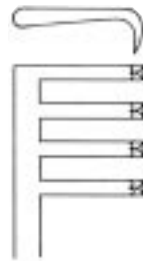

17.5612

3x4
 spitz
 sharp
 pointu
 agudo
 acuto



17.5613

3x4
 stumpf
 blunt
 mousses
 romo
 smusso



CLOWARD-CONTOUR

17.5460 13,5 cm

1x1 spitz / sharp / pointu / agudo / acuto

17.5461 13,5 cm

1x1 stumpf / blunt / mousse / romo / smusso



CLOWARD-CONTOUR

17.5462 13,5 cm

3x3 spitz / sharp / pointu / agudo / acuto

17.5463 13,5 cm

3x3 stumpf / blunt / mousse / romo / smusso



CHARNLEY
17.5590
28 cm
Horizontalspreizer
Horizontal Spreader
Ecarteur horizontal
Separador horizontal
Divaricatore orizzontale



SEXTON
17.5596
31 cm

WUNDSPREIZER
SELF-RETAINING RETRACTORS
ECARTEURS AUTOSTATIQUES
SEPARADORES AUTOSTATICOS
DIVARICATORI AUTOSTATICI

spitz
 sharp
 pointu
 agudo
 acuto

stumpf
 blunt
 mousses
 romo
 smusso



17.5600
 14 cm



17.5601
 14 cm



17.5602
 16,5 cm



17.5603
 16,5 cm



17.5604
 20 cm



17.5605
 20 cm

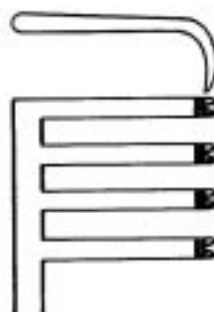

17.5606
 26 cm

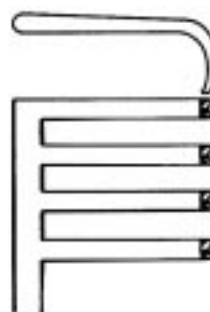

17.5607
 26 cm



BECKMANN-WEITLANER
(ADSON, CONE)

spitz
sharp
pointu
agudo
acuto

7x7
spitz
sharp
pointu
agudo
acuto



BECKMANN
17.5610 31 cm

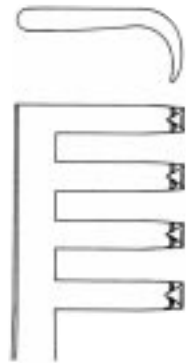

BECKMANN-EATON
17.5620 32 cm

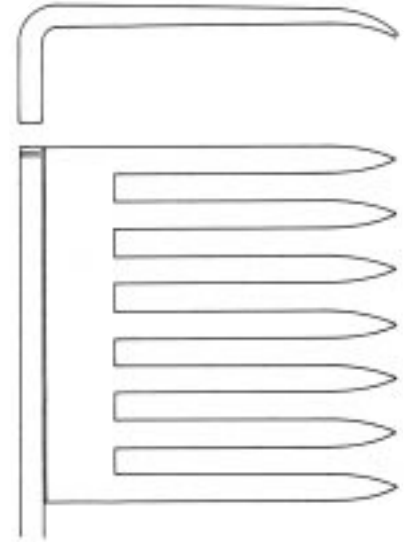

WUNDSPREIZER
SELF-RETAINING RETRACTORS
ECARTEURS AUTOSTATIQUES
SEPARADORES AUTOSTATICOS
DIVARICATORI AUTOSTATICI

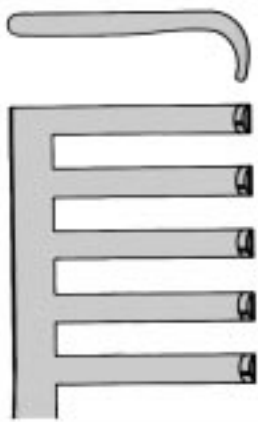

4x5
 stumpf
 blunt
 mousses
 romo
 smusso

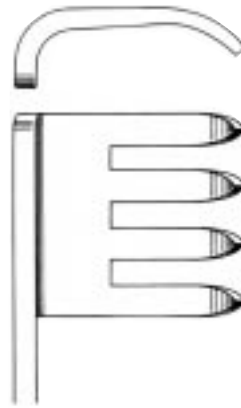

spitz
 sharp
 pointu
 agudo
 acuto

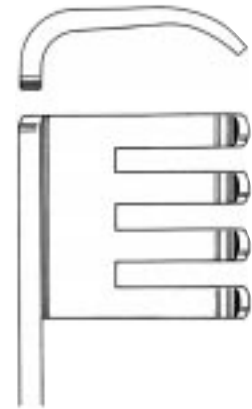

stumpf
 blunt
 mousses
 romo
 smusso

17.5635 25 mm

17.5636 25 mm



ADSON
17.5632 32 cm



BECKMANN-ADSON
 31 cm

spitz
 sharp
 pointu
 agudo
 acuto



17.5637 44 mm

stumpf
 blunt
 mousses
 romo
 smusso



17.5638 44 mm

spitz
sharp
pointu
agudo
acuto

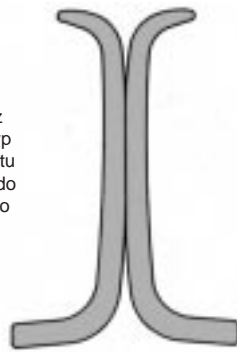

HARVEY-JACKSON
17.5640
28 cm

WUNDSPREIZER
SELF-RETAINING RETRACTORS
ECARTEURS AUTOSTATIQUES
SEPARADORES AUTOSTATICOS
DIVARICATORI AUTOSTATICI

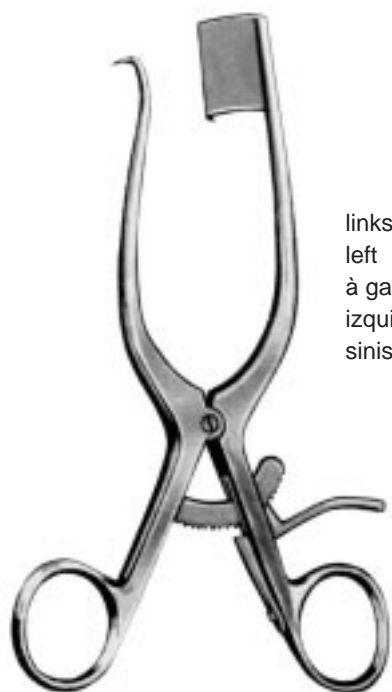

links
 left
 à gauche
 izquierda
 sinistra

MARKHAM-MEYERDING
 17.5660 18 cm

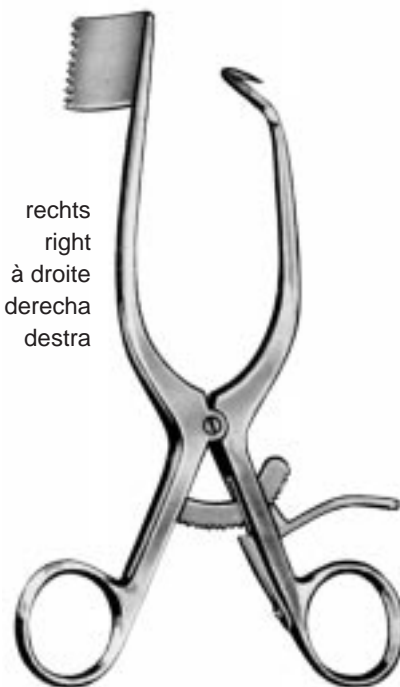

rechts
 right
 à droite
 derecha
 destra

MARKHAM-MEYERDING
 17.5662 18 cm



MEYERDING
 20 cm

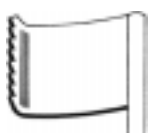

17.5665 32 x 25 mm



17.5666 54 x 25 mm



17.5667 60 x 19 mm



17.5668 60 x 25 mm

76x40

64x25 mm



DARLING
17.5670 18 cm

64x25

76x40 mm



DARLING
17.5672 18 cm



DEBAKEY-FEMUR
17.5890
10 cm

Kinder
children
enfants
niños
bambini



DEBAKEY-FEMUR
17.5892
14,5 cm



JOLL (FRIEDMANN)
55.0500
10 cm



GELPI-MINI
17.5899 10 cm



GELPI-BABY
17.5900 14 cm



GELPI
18 cm
17.5901 spitz / sharp / pointu / agudo / acuto
17.5902 stumpf / blunt / mousse / romo / smusso



GELPI
17.5905 18 cm



GELPI-SELETZ
17.5907 15 cm



JACKSON-BURROWS
17.5908 18,5 cm



GELPI-ORTHO
17.5906
30 cm



MORRIS-MITRAL
40.3400
16 cm

Gefäßwundspreizer
Vascular Retractor
Ecarteur vasculaire
Separador vascular
Divaricatore vascolar

WUNDSPREIZER
SELF-RETAINING RETRACTORS
ECARTEURS AUTOSTATIQUES
SEPARADORES AUTOSTATICOS
DIVARICATORI AUTOSTATICI



TUEBINGEN
17.5910 16,5 cm



RIGBY
17.5930 18 cm
 60 x 20 mm



RIGBY
17.5932 18 cm
 35 x 20 mm



HENLEY
 16,5 cm
 mit Mittelvalven
 with center blades
 avec valves centrales
 con valvas centrales
 con valve centrale

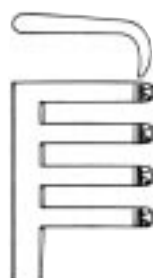

17.5980



17.5982

17.5985 - 17.5987
 17.5985 - 17.5987
 17.5985 - 17.5987
 17.5985 - 17.5987
 17.5985 - 17.5987



17.5985
 16 x 20 mm



17.5986
 16 x 25 mm



17.5987
 16 x 30 mm

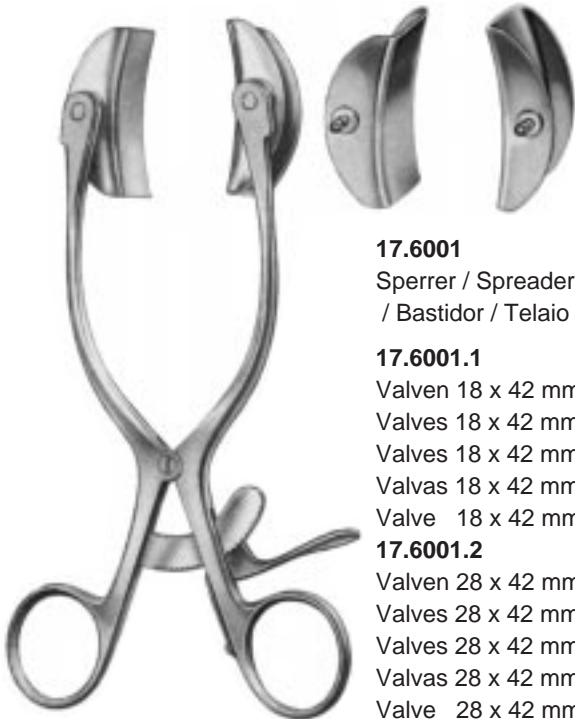

17.6001
 Sperrer / Spreader / Cadre
 / Bastidor / Telaio

17.6001.1
 Valven 18 x 42 mm (Paar)
 Valves 18 x 42 mm (Pair)
 Valves 18 x 42 mm (Paire)
 Valvas 18 x 42 mm (Par)
 Valve 18 x 42 mm (Paio)

17.6001.2
 Valven 28 x 42 mm (Paar)
 Valves 28 x 42 mm (Pair)
 Valves 28 x 42 mm (Paire)
 Valvas 28 x 42 mm (Par)
 Valve 28 x 42 mm (Paio)



COLLIN
17.6002 22 cm
 38 x 60 mm

Valven / Lateral blades / valves
 latÉrales / valvas laterales /
 valve laterali 38 x 60 mm



COLLIN
 22 cm
17.6003

Seitenvalven / Lateral blades / valves
 latÉrales / valvas laterales / valve
 laterali 38 x 60 mm
 Mittelvalve / center blade / valve
 central / valva centrale / valva
 centrale 38 x 55 mm

17.6004
 Seitenvalven / Lateral blades / valves
 latÉrales / valvas laterales / valve
 laterali 38 x 80 mm
 Mittelvalve / center blade / valve
 central / valva centrale / valva
 centrale 50 x 75 mm

COLLIN-BABY

17.6000 18 cm

bestehend aus:

- 17.6001 Rahmen
- 17.6001.1 1 Paar Valven 18x42 mm
- 17.6001.2 1 Paar Valven 28x42 mm

consisting of:

- 17.6001 Frame
- 17.6001.1 Blades 18x42 mm (Pair)
- 17.6001.2 Blades 28x42 mm (Pair)

comprenant:

- 17.6001 cadre seul
- 17.6001.1 valves 18x42 mm (paire)
- 17.6001.2 valves 28x42 mm (paire)

compuesto de:

- 17.6001 bastidor suelto
- 17.6001.1 valvas 18x42 mm (par)
- 17.6001.1 valvas 28x42 mm)

composto da:

- 17.6001 Telaio solo
- 17.6001.1 valve 18x42mm (par)
- 17.6001.2 valve 28x42 mm (par)



COLLIN-LOCKTITE

17.6007 26 cm

60 x 80 mm

Seitenvalven / Lateral blades /
valves latérales / valvas laterales /
valve laterali 60 x 80 mm

Mittelvalve / center blade /
valve central / valva centrale /
valva centrale 60 x 75 mm



LEGUEU

17.6010 18 cm



MAYO-ADAMS

17.6015 17 cm



HOLZBACH
17.6020



RICARD

17.6030 28 cm

Mittelvalve 55x70mm, Seitenvalven 50x58mm
Centervalue 55x70, lateral blades 50x58 mm
valve centrale 55x70, valves laterales 50x58mm
valva central 55x70, valvas laterales 50x58mm
valva centrale 55x70, valve laterali 50x58mm

17.6035 30 cm

Mittelvalve 80x90mm, Seitenvalven 60x80mm
Centervalue 80x90, lat. blades 60x80 mm
valve centrale 80x90, valves laterales 60x80mm
valva central 80x90, valvas laterales 60x80mm
valva centrale 80x90, valve laterali 60x80mm

BAUCHDECKENHALTER
 ABDOMINAL RETRACTORS
 ECARTEURS ABDOMINAUX
 SEPARADORES ABDOMINALES
 DIVARICATORI ADDOMINALI

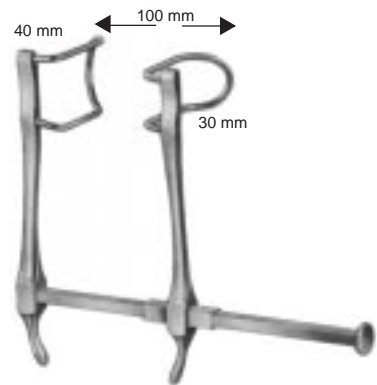

GOSSET
 17.6100 100 mm

ROBIN-MASSE

17.6040 21cm

Mittelvalve 40x64mm, Seitenvlaven 38x62mm
 Centervlve 40x64, lat. blades 38x62 mm
 valve centrale 40x64, valves laterales 38x62mm
 valva central 40x64, valvas laterales 38x62mm
 valva centrale 40x64, valve laterali 38x62mm

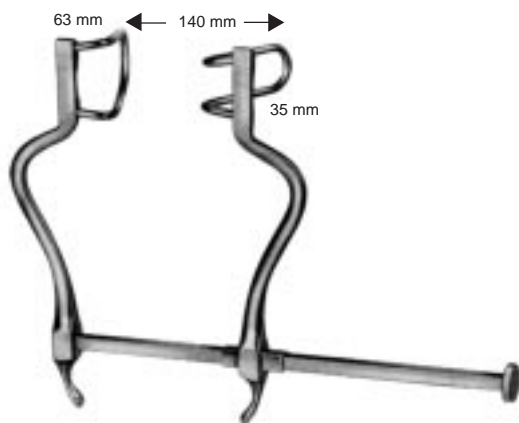

GOSSET
 17.6101 140mm

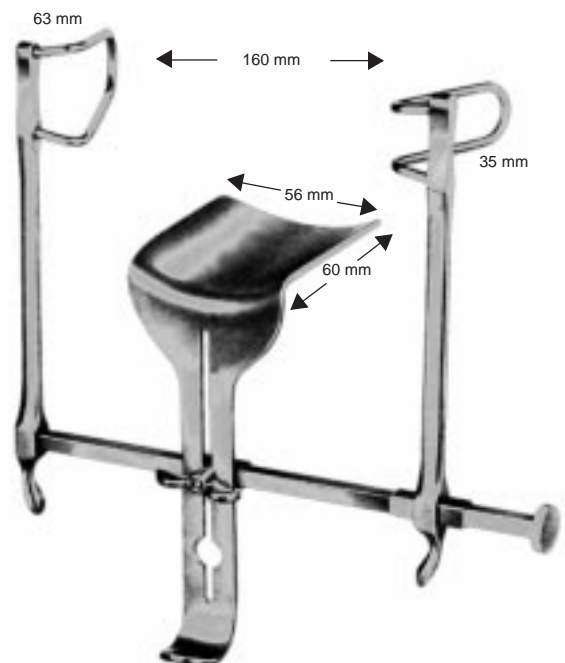

GOSSET
 17.6102 160mm

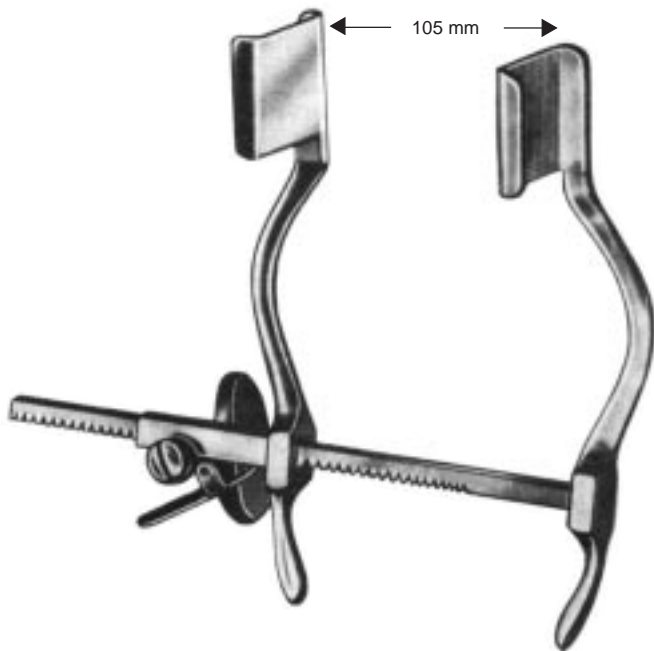

HERTZLER
17.6110

Spreizweite / spread / écartement / abertura / apertura 105 mm
 Tiefe, Breite / Depth, Width / profondeur, largeur /
 profundidad, ancho / profondità, larghezza : 25 x 25 mm



BALFOUR-BABY
17.6150 90 mm

Spreizweite / spread / écartement / abertura / apertura 90 mm

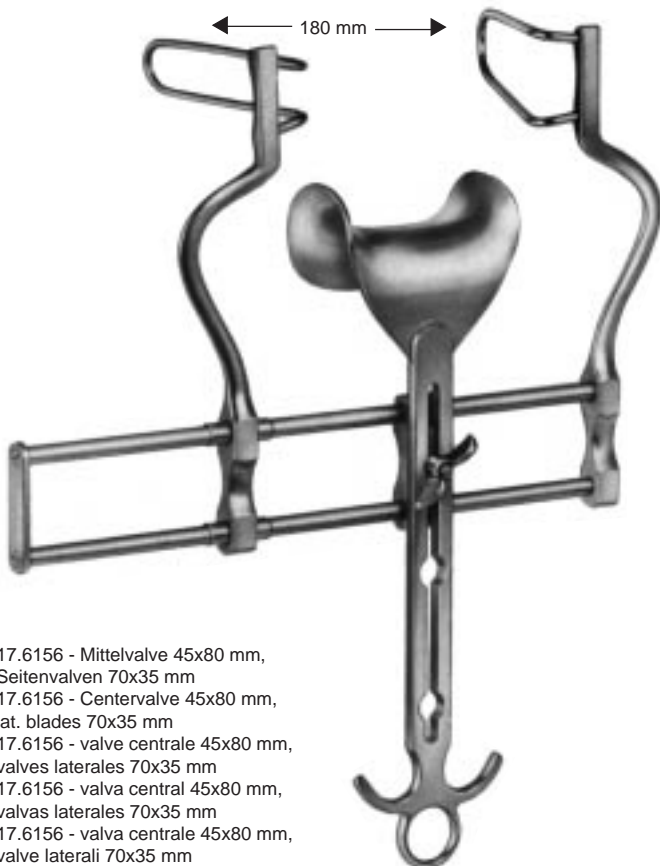

17.6156 - Mittelvalve 45x80 mm,
 Seitenvälven 70x35 mm
 17.6156 - Centervälve 45x80 mm,
 lat. blades 70x35 mm
 17.6156 - valve centrale 45x80 mm,
 valves laterales 70x35 mm
 17.6156 - valva central 45x80 mm,
 valvas laterales 70x35 mm
 17.6156 - valva centrale 45x80 mm,
 valve laterali 70x35 mm

BALFOUR
17.6152 180 mm

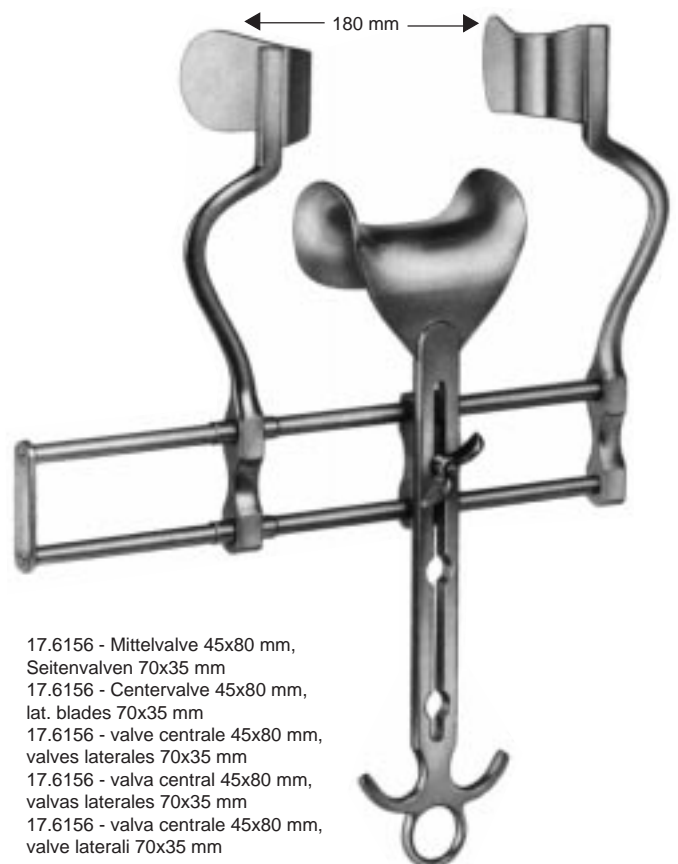

17.6156 - Mittelvalve 45x80 mm,
 Seitenvälven 70x35 mm
 17.6156 - Centervälve 45x80 mm,
 lat. blades 70x35 mm
 17.6156 - valve centrale 45x80 mm,
 valves laterales 70x35 mm
 17.6156 - valva central 45x80 mm,
 valvas laterales 70x35 mm
 17.6156 - valva centrale 45x80 mm,
 valve laterali 70x35 mm

BALFOUR
17.6153 180 mm

BAUCHDECKENHALTER
ABDOMINAL RETRACTORS
ECARTEURS ABDOMINAUX
SEPARADORES ABDOMINALES
DIVARICATORI ADDOMINALI

- 17.6158 - Mittelvalve 70x85, Seitenvalven 100x35 mm
- 17.6158 - Centervalue 70x85, lateral blades 100x35 mm
- 17.6158 - valve centrale 70x85, valves laterales 100x35 mm
- 17.6158 - valva central 70x85, valvas laterales 100x35 mm
- 17.6158 - valva centrale 70x85, valve laterali 100x35 mm

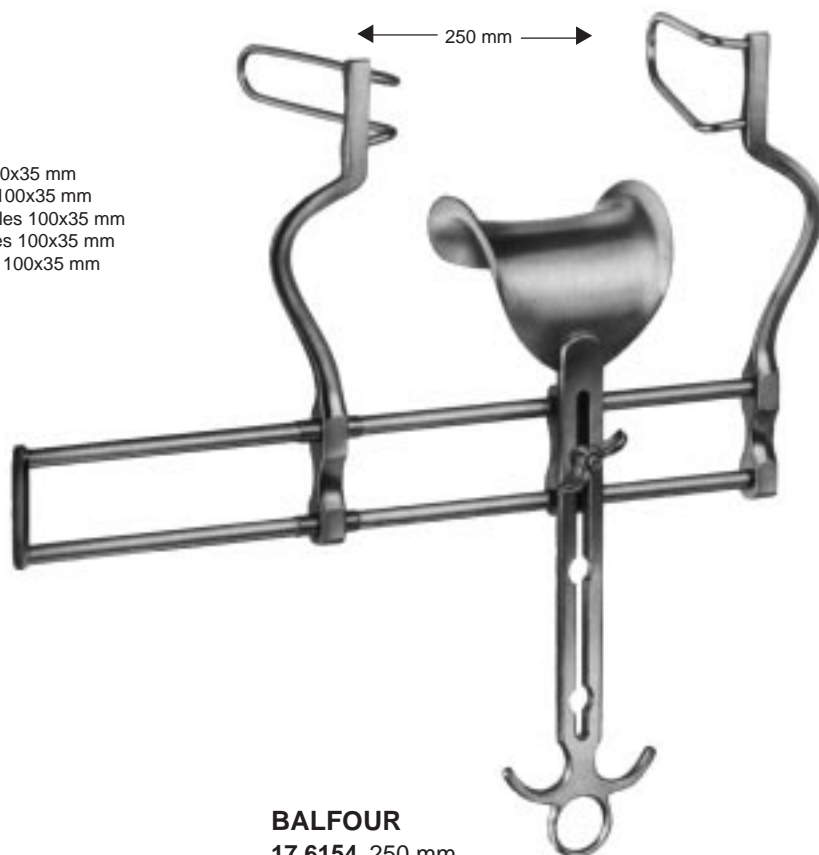

BALFOUR
17.6154 250 mm

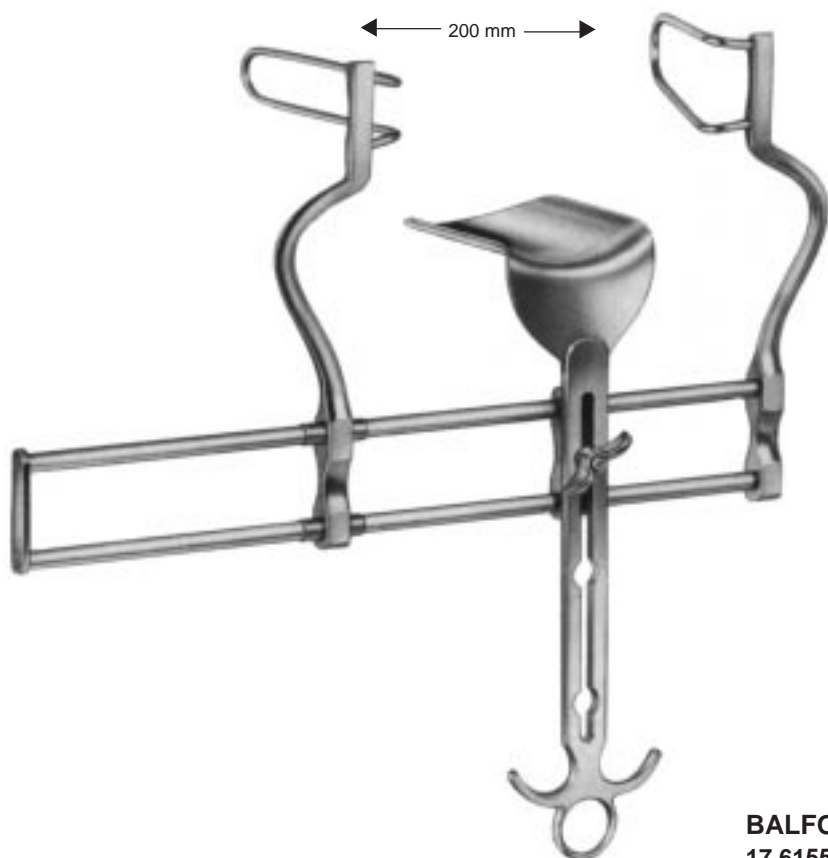

- 17.6157 - Mittelvalve 100x70mm,Seitenvalven 100x35 mm
- 17.6157 - Centervalue 100x70, lateral blades 100x35 mm
- 17.6157 - valve centrale 100x70, valves laterales 100x35 mm
- 17.6157 - valva central 100x70, valvas laterales 100x35 mm
- 17.6157 - valva centrale 100x70, valve laterali 100x35 mm

BALFOUR
17.6155 200 mm

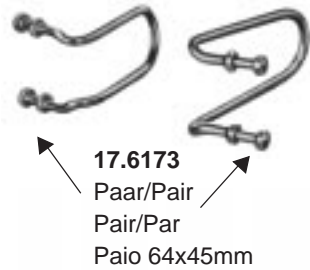

17.6178L
 Seitenarm links
 4th blade attachment left
 Bras latéral à gauche
 Brazo lateral izquierdo
 Braccio lateral sinistra

17.6178R
 Seitenarm rechts
 4th blade attachment right
 Bras latéral à droite
 Brazo lateral derecho
 Braccio lateral destra



BALFOUR-Modif.
 17.6170 200 mm
 17.6172 265 mm
 komplett/completo/
 complet/completo/completo

BALFOUR
 17.6178L
 17.6178R

Mittelvalven für Bauchdeckenhalter
 Center blades
 Valves centrales
 Valvas centrales
 Valve centrali



BALFOUR
 17.6156 45 x 80 mm
 17.6158 70 x 85 mm
 17.6159 80 x 90 mm

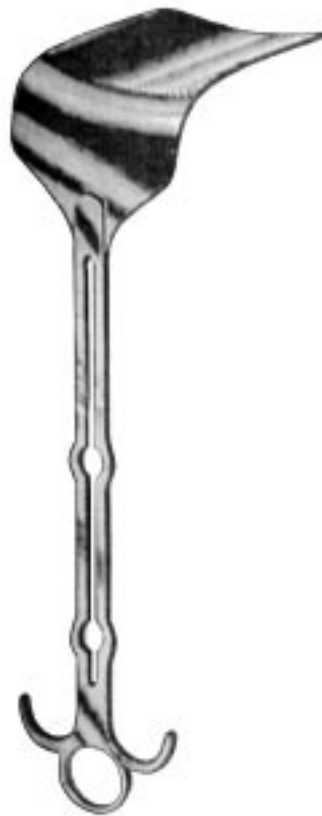

BALFOUR
 17.6157 100 x 70 mm



HORGAN
 17.6176 51 x 198 mm



HORGAN
 17.6177 51 x 127 mm

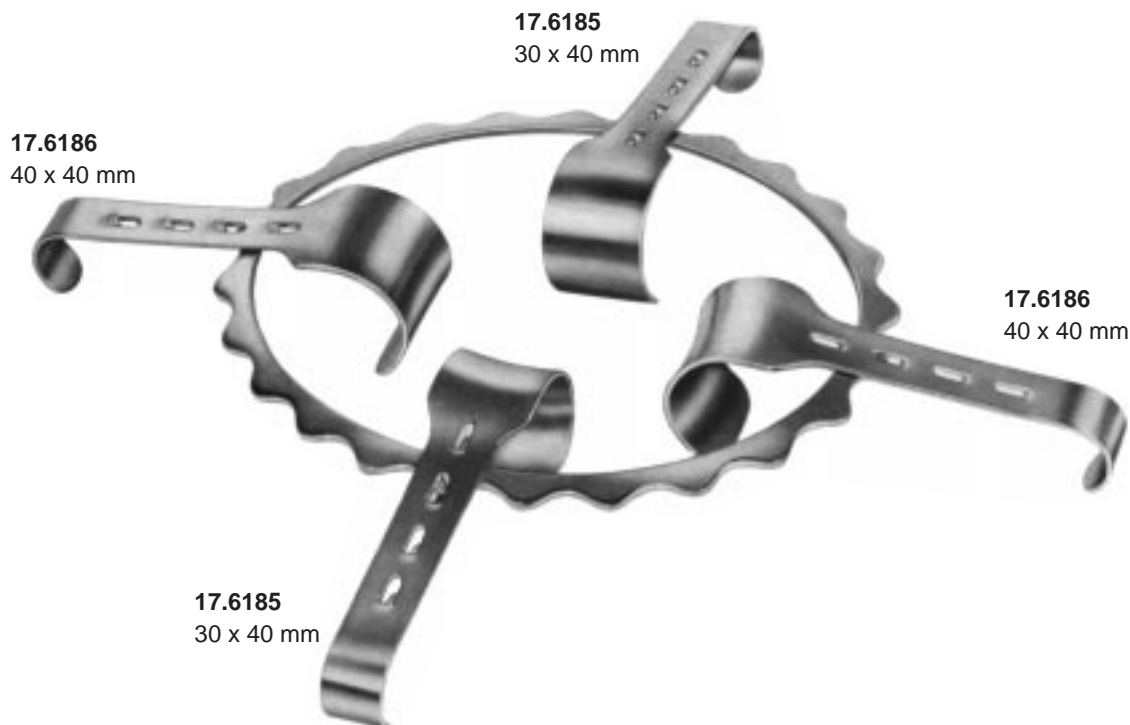

DENIS-BROWN

- 17.6180** für Kinder, bestehend aus:
 17.6181 Rahmen 180x150 mm
 17.6185 2 Valven 30x40 mm
 17.6186 2 Valven 40x40 mm
 for children, consisting of:
 17.6181 Frame 180x150 mm
 17.6185 2 valves 30x40 mm
 17.6186 2 valves 40x40 mm
 pour enfants, comprenant:
 17.6181 cadre 180x150 mm
 17.6185 2 valves 30x40 mm
 17.6186 2 valves 40x40 mm
 para niños, compuesto de:
 17.6181 cuadro 180x50 mm
 17.6185 2 valvas 30x40 mm
 17.6186 2 valvas 40x40 mm
 per bambini, composto da:
 17.6181 telaio 180x150 mm
 17.6185 2 valve 30x40 mm
 17.6186 2 valve 40x40 mm

DENIS-BROWN

- 17.6182** für Erwachsene, bestehend aus:
 17.6183 Rahmen 255x180 mm
 17.6185 2 Valven 30x40 mm
 17.6186 2 Valven 40x40 mm
 for adults, consisting of:
 17.6183 Frame 255x180 mm
 17.6185 2 valves 30x40 mm
 17.6186 2 valves 40x40 mm
 pour adultes, comprenant:
 17.6183 cadre 255x180 mm
 17.6185 2 valves 30x40 mm
 17.6186 2 valves 40x40 mm
 para adultos, compuesto de:
 17.6183 cuadro 255x180 mm
 17.6185 2 valvas 30x40 mm
 17.6186 2 valvas 40x40 mm
 per adulti, composto da:
 17.6183 telaio 255x180 mm
 17.6185 2 valve 30x40 mm
 17.6186 2 valve 40x40 mm

DENIS-BROWN

- 17.6181** Rahmen / frame / cadre / cuadro / telaio 180 x150 mm
17.6183 Rahmen / frame / cadre / cuadro / telaio 255 x180 mm

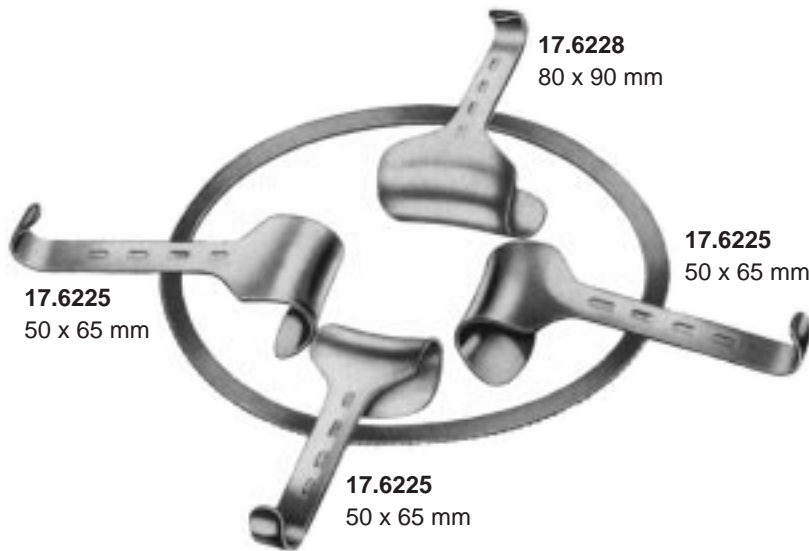

KIRSCHNER

17.6210

- bestehend aus:
 17.6211 ovaler Rahmen 300x240 mm
 17.6225 3 Valven 50x65 mm
 17.6228 1 Valve 80x90 mm
 17.6229 1 Valve 98x50 mm
 17.6230 1 Valve 105x35 mm
 consisting of:
 17.6211 oval Frame 300x240 mm
 17.6225 3 valves 50x65 mm
 17.6228 1 valve 80x90 mm
 17.6229 1 valve 98x50 mm
 17.6230 1 valve 105x35 mm
 comprenant:
 17.6211 cadre oval 300x240 mm
 17.6225 3 Valves 50x65 mm
 17.6228 1 Valve 80x90 mm
 17.6229 1 Valve 98x50 mm
 17.6230 1 Valve 105x35 mm
 compuesto de:
 17.6211 cuadro oval 300x240 mm
 17.6225 3 valvas 50x65 mm
 17.6228 1 valva 80x90 mm
 17.6229 1 valva 98x50 mm
 17.6230 1 valva 105x35 mm
 composto da:
 17.6211 telaio oval 300x240 mm
 17.6225 3 valve 50x65 mm
 17.6228 1 valva 80x90 mm
 17.6229 1 valva 98x50 mm
 17.6230 1 valva 105x35 mm

KIRSCHNER

17.6211 300x240 mm

Rahmen allein / Frame only / Cadre, seul / Cuadro, solo / Telaio, solo

KIRSCHNER

17.6220

- bestehend aus:
 17.6222 starrer Rahmen 250x250 mm
 17.6224 2 Valven 42 x 55 mm
 17.6225 2 Valven 50 x 65 mm
 consisting of:
 17.6222 rigid frame 250x250 mm
 17.6224 2 valves 42 x 55 mm
 17.6225 2 valves 50 x 65 mm
 comprenant:
 17.6222 cadre fixe 250 x 250 mm
 17.6224 2 valves 42 x 55 mm
 17.6225 2 valves 50 x 65 mm
 compuesto de:
 17.6222 cuadro fijo 250 x 250 mm
 17.6224 2 valvas 42 x 55 mm
 17.6225 2 valvas 50 x 65 mm
 composto da:
 17.6222 telaio fisso 250 x 250 mm
 17.6224 2 valve 42 x 55 mm
 17.6225 2 valce 50 x 65 mm

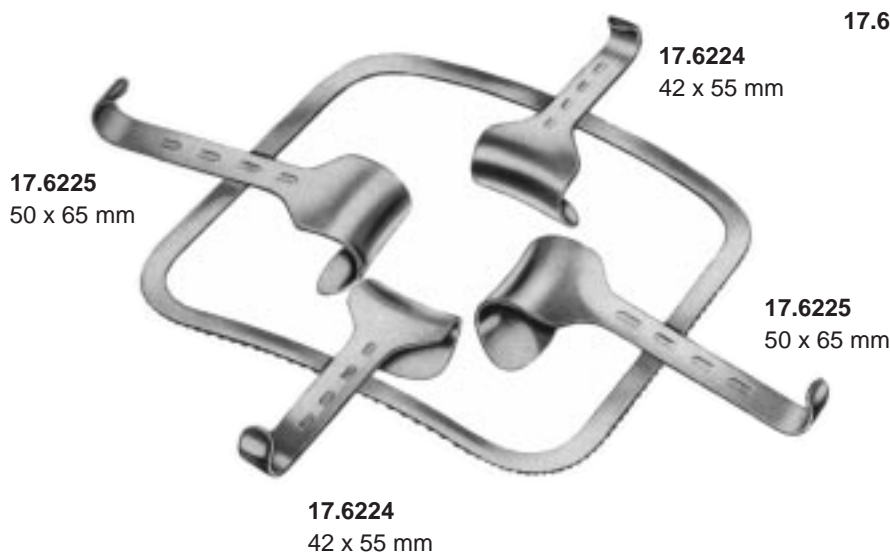

KIRSCHNER

17.6222 Rahmen allein / Frame only / Cadre, seul / Cuadro, solo / Telaio, solo



KIRSCHNER

- 17.6221** bestehend aus:
 17.6219 faltbarer Rahmen 250x250 mm
 17.6224 2 Valven 42 x 55 mm
 17.6225 2 Valven 50 x 65 mm
 consisting of:
 17.6219 folding frame 250x250 mm
 17.6224 2 valves 42 x 55 mm
 17.6225 2 valves 50 x 65 mm
 comprenant:
 17.6219 cadre pliant 250 x 250 mm
 17.6224 2 valves 42 x 55 mm
 17.6225 2 valves 50 x 65 mm
 compuesto de:
 17.6219 cuadro plegable 250 x 250 mm
 17.6224 2 valvas 42 x 55 mm
 17.6225 2 valvas 50 x 65 mm
 composto da:
 17.6219 telaio pieghevole 250 x 250 mm
 17.6224 2 valve 42 x 55 mm
 17.6225 2 valce 50 x 65 mm

17.6219 250x250 mm
 Rahmen allein / Frame only / Cadre, seul /
 Cuadro, solo / Telaio, solo

KIRSCHNER

Haken / Blades / Lames / Valvas / Valve



17.6224
 42 x 55 mm

17.6225
 50 x 65 mm

17.6226
 60 x 85 mm

17.6227
 78 x 65 mm

17.6228
 80 x 90 mm

17.6229
 98 x 50 mm

17.6230
 105 x 35 mm

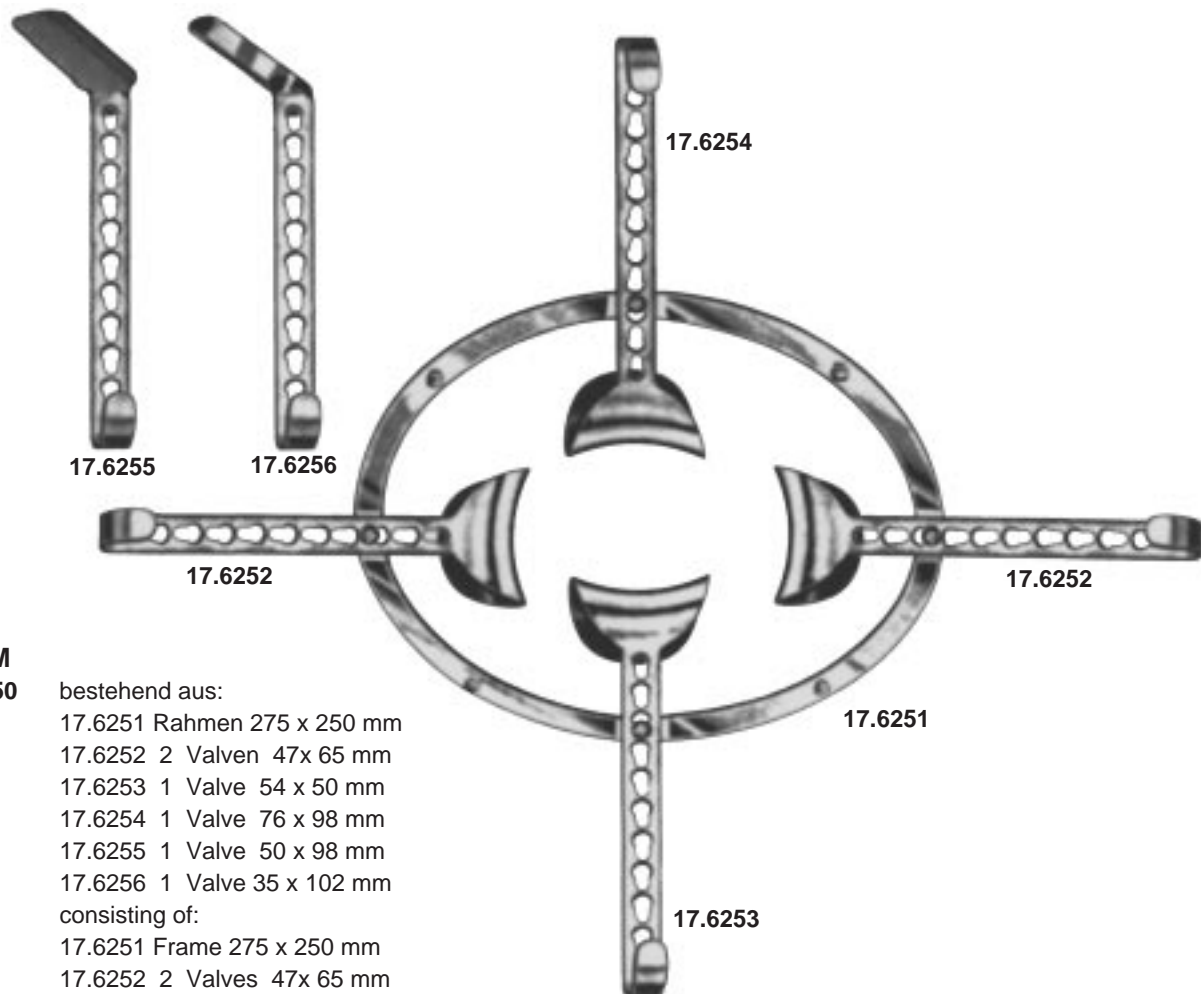

SEMM
17.6250

bestehend aus:

- 17.6251 Rahmen 275 x 250 mm
- 17.6252 2 Valven 47x 65 mm
- 17.6253 1 Valve 54 x 50 mm
- 17.6254 1 Valve 76 x 98 mm
- 17.6255 1 Valve 50 x 98 mm
- 17.6256 1 Valve 35 x 102 mm

consisting of:

- 17.6251 Frame 275 x 250 mm
- 17.6252 2 Valves 47x 65 mm
- 17.6253 1 Valve 54 x 50 mm
- 17.6254 1 Valve 76 x 98 mm
- 17.6255 1 Valve 50 x 98 mm
- 17.6256 1 Valve 35 x 102 mm

comprenant:

- 17.6251 Cadre 275 x 250 mm
- 17.6252 2 Valves 47x 65 mm
- 17.6253 1 Valve 54 x 50 mm
- 17.6254 1 Valve 76 x 98 mm
- 17.6255 1 Valve 50 x 98 mm
- 17.6256 1 Valve 35 x 102 mm

compuesto de:

- 17.6251 Cuadro 275 x 250 mm
- 17.6252 2 Valvas 47x 65 mm
- 17.6253 1 Valva 54 x 50 mm
- 17.6254 1 Valva 76 x 98 mm
- 17.6255 1 Valva 50 x 98 mm
- 17.6256 1 Valva 35 x 102 mm

composto da:

- 17.6251 Telaio 275 x 250 mm
- 17.6252 2 Valve 47x 65 mm
- 17.6253 1 Valva 54 x 50 mm
- 17.6254 1 Valva 76 x 98 mm
- 17.6255 1 Valva 50 x 98 mm
- 17.6256 1 Valva 35 x 102 mm

SEMM

17.6251 275 x 250 mm
 Rahmen allein / Frame only / Cadre, seul /
 Cuadro, solo / Telaio, solo

17.6252 47 x 65 mm

17.6253 54 x 50 mm

17.6254 76 x 98 mm

17.6255 50 x 98 mm

17.6256 35 x 135 mm

Valve / Blades / Lames / Valvas / Valve

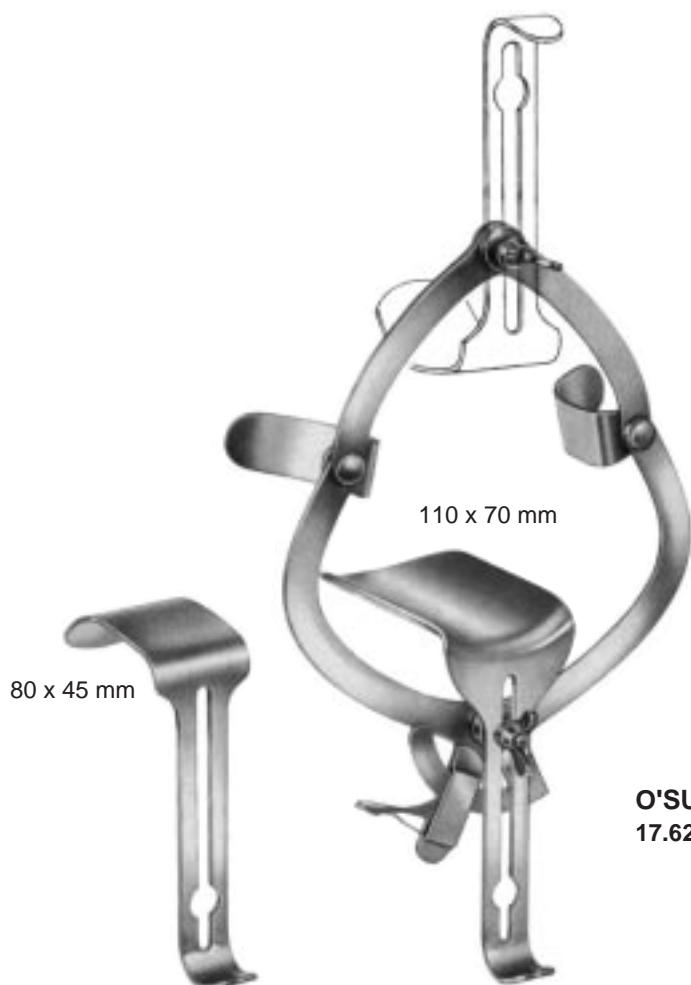

O'SULLIVAN-O'CONNOR

17.6260

bestehend aus:

17.6261 Rahmen mit 2 Seitenvallen 62 x 25 mm

17.6262 2 Valven 85 x 45 mm

17.6263 1 Valve 105 x 70 mm

consisting of:

17.6261 Frame with 2 lateral valves 62 x 25 mm

17.6262 2 Valves 85 x 45 mm

17.6263 1 Valve 105 x 70 mm

comprenant:

17.6261 Cadre avec 2 valves latérales 62 x 25 mm

17.6262 2 Valvex 85 x 45 mm

17.6263 1 Valve 105 x 70 mm

compuesto de:

17.6261 Cuadro con 2 valvas laterales 62 x 25 mm

17.6262 2 Valves 85 x 45 mm

17.6263 1 Valva 105 x 70 mm

composta da:

17.6261 Telaio con 2 valve laterali 62 x 25 mm

17.6262 2 Valve 85 x 45 mm

17.6263 1 Valva 105 x 70 mm

17.6261

Rahmen allein / Frame only / Cadre, seul /
Cuadro, solo / Telaio, solo

17.6262

45 x 85 mm

17.6263

70 x 105 mm

Valve / Blades / Lames / Valvas / Valve



ROCHARD
17.6277
 Rahmen, doppelt
 Frame, double
 Cadre, double
 Quadro doble
 Telaio doppio

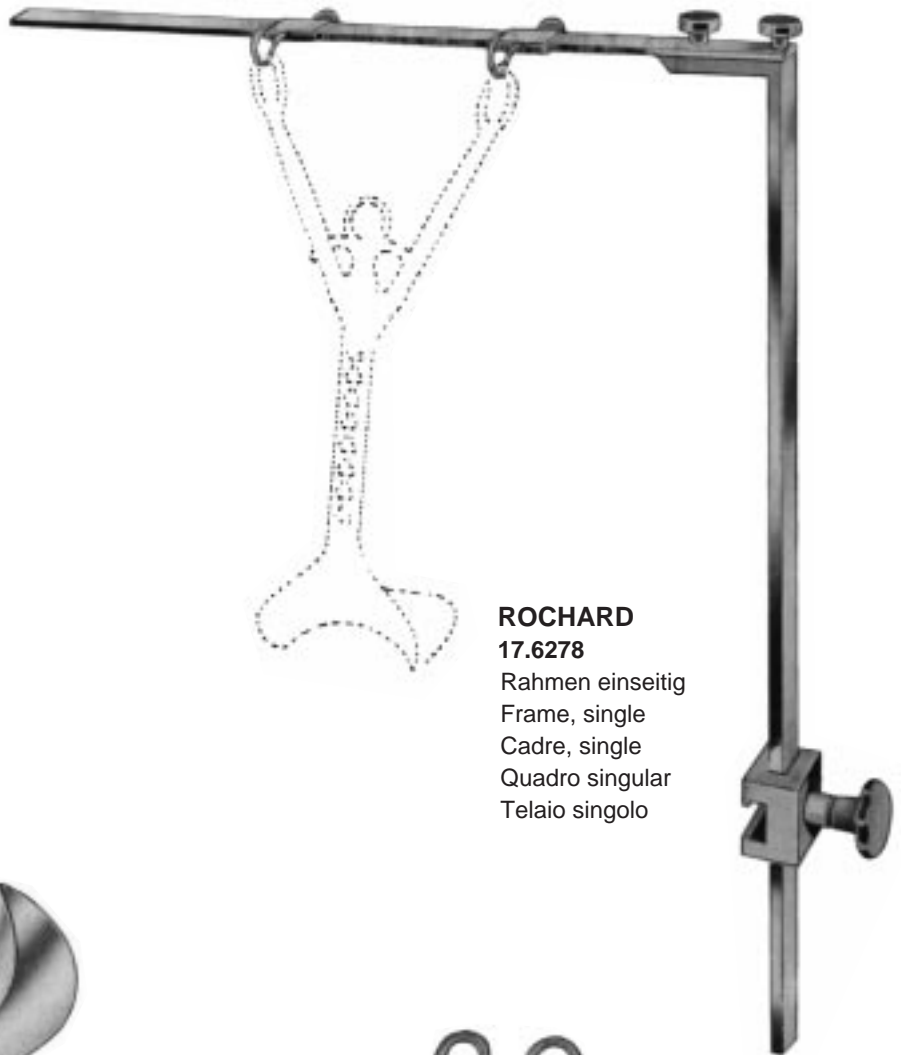

ROCHARD
17.6278
 Rahmen einseitig
 Frame, single
 Cadre, single
 Quadro singular
 Telaio singolo



ROCHARD
17.6270 95 mm
17.6271 105 mm
17.6272 120 mm
17.6273 135 mm
17.6274 155 mm



ROCHARD
17.6279
 Fixiervorrichtung
 Fixation device
 Compas articulé
 Dispositivo de fijación
 Dispositivo di fissaggio



DOYEN

17.6350 55 x 95 mm
17.6353 55 x 105 mm
17.6354 55 x 115 mm
17.6355 55 x 125 mm



ABDOMINAL

46.0169 20,5 cm
Spekulum 70 mm / 90°
Abdominal Specula 70 mm / 90°
Spéculum abdominal 70 mm / 90°
espéculeo abdominale 70 mm / 90°
Specola abdominale 70 mm / 90°



17.6309 8 mm ø
20 Ersatzknöpfe
20 Spare buttons
20 Boutons de rechange
20 Botónes de repuesto
20 Bottone de ricambio

FOERSTER

17.6300 Ø 255 mm

Kunststoff, schwarz, röntgenfähig, komplett mit 4 Valven Nr. 17.6303
plastic, black, transparent to X-Ray, complete with 4 valves 17.6303
plastique, noir, transparent aux rayons X, complet avec 4 valves 17.6303
plástico, negro, transparente a los rayos-X, completo con 4 valvas 17.6303
plastica, nero, radiotrasparente, completo con 4 valve 17.6303

17.6301

Rahmen / frame / Cadre / Cuadro / Telaio Ø 255 mm



17.6303 50 x 65 mm



17.6304 65 x 75 mm

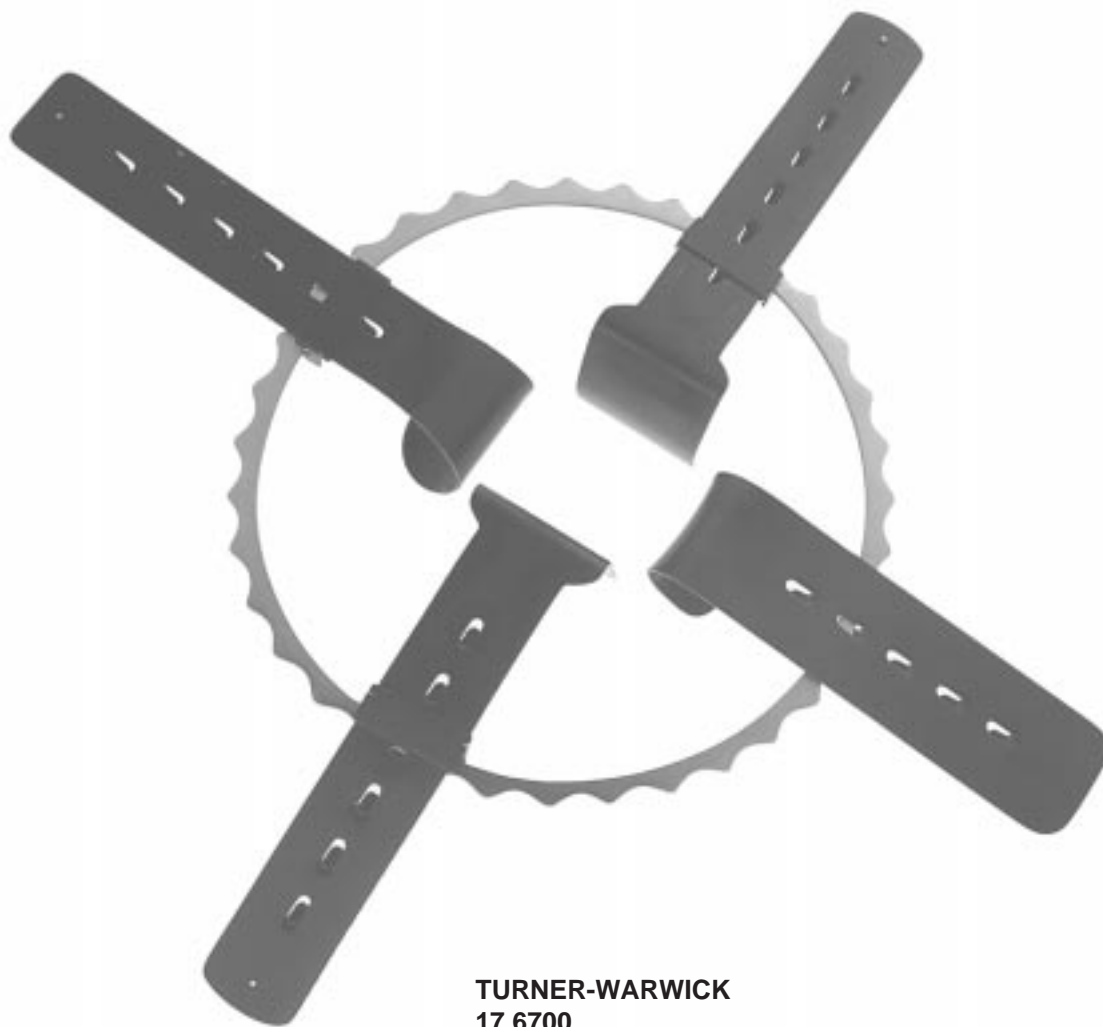

**TURNER-WARWICK
17.6700**

bestehend aus

consisting of:

comprendant:

compuesto de:

composta da:

17.6701 1

17.6702 1

17.6703 1

17.6710 2

17.6711 2

17.6712 2

17.6713 2

17.6714 2

17.6715 2

17.6716 2

17.6717 2

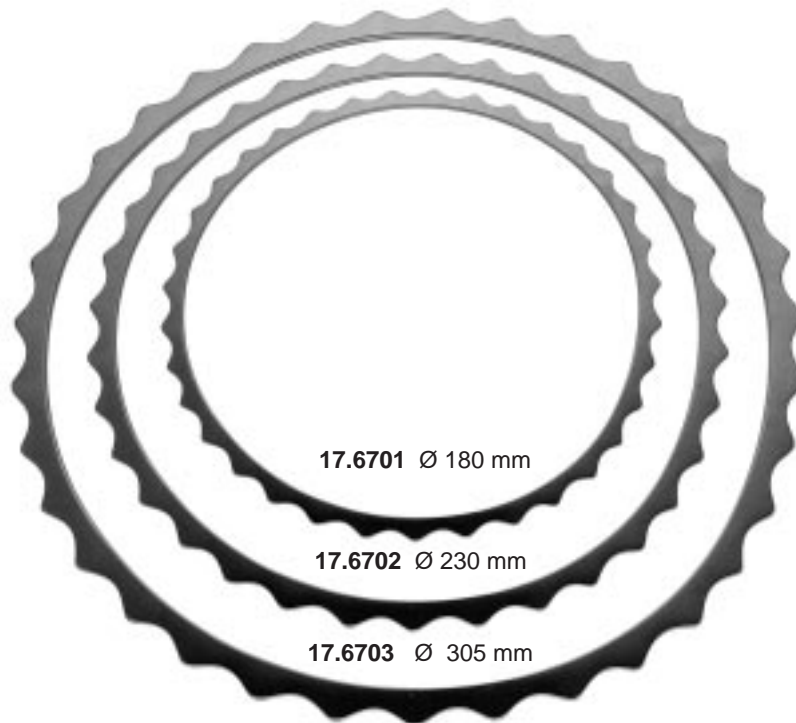

17.6701 Ø 180 mm

17.6702 Ø 230 mm

17.6703 Ø 305 mm

TURNER-WARWICK

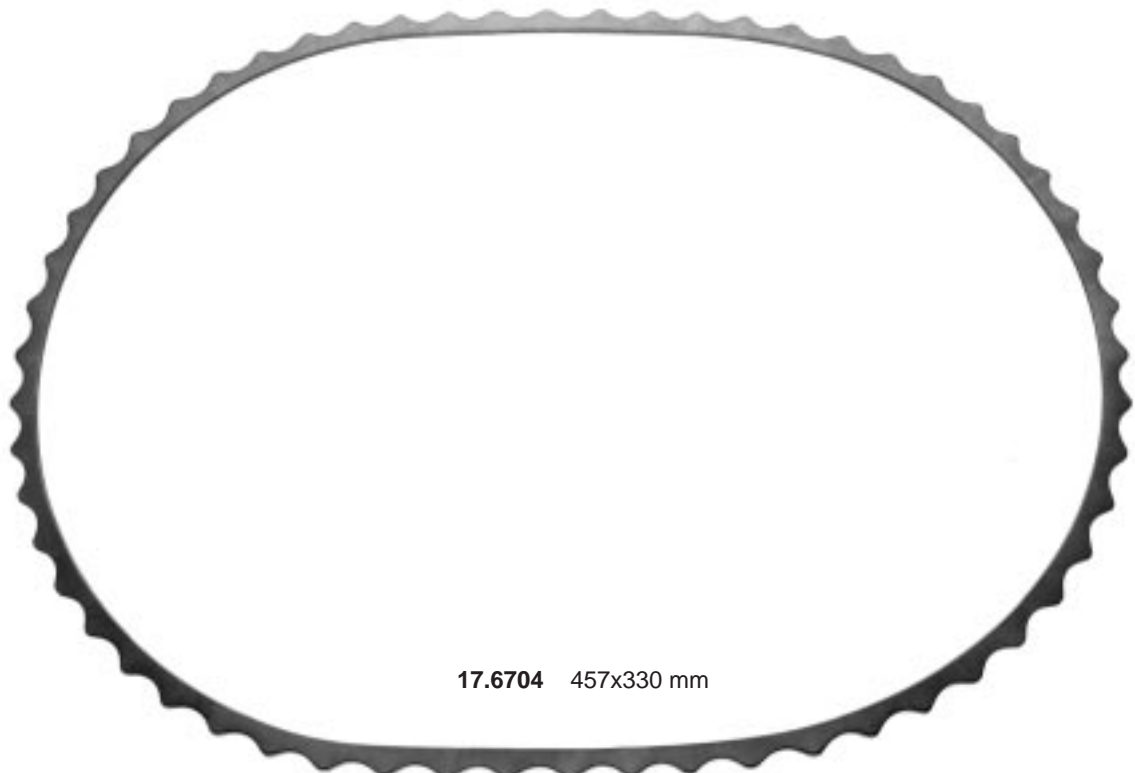

17.6704 457x330 mm

TURNER-WARWICK



TURNER-WARWICK
17.6710 76 x 19 mm

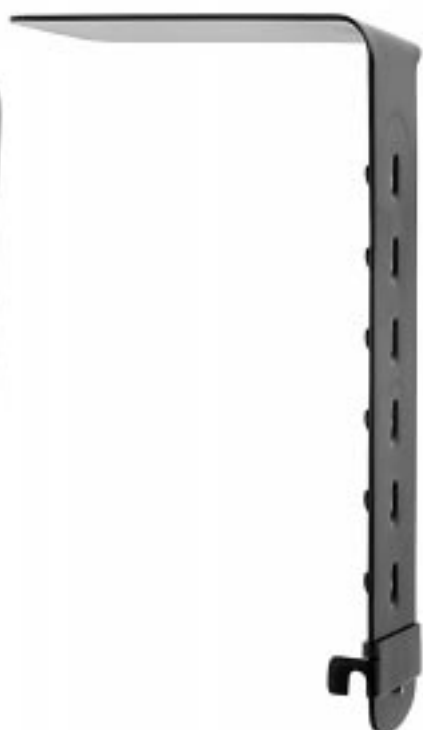

TURNER-WARWICK
17.6711 102 x 38 mm



TURNER-WARWICK
17.6712 89 x 57 mm



TURNER-WARWICK
17.6713 114 x 57 mm



TURNER-WARWICK
17.6714 51 x 38 mm



TURNER-WARWICK
17.6715 76 x 60 mm



TURNER-WARWICK
17.6716 89 x 60 mm
17.6717 114 x 60 mm



TURNER-WARWICK
17.6718 13 mm

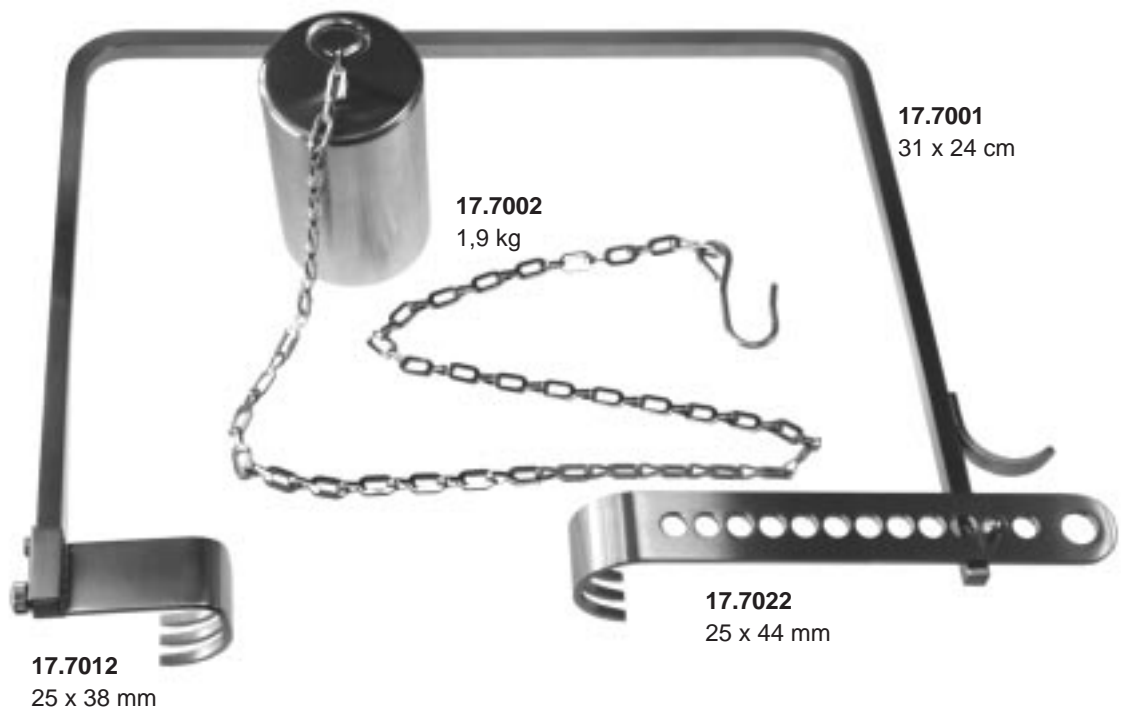

CHARNLEY compl.
17.7000

bestehend aus:

consisting of:

comprendant:

compuesto de:

composta da:

17.7001 Rahmen / Frame / Cadre / Cuadro / Telaio 31 x 24 cm

17.7002 Gewicht mit Kette / Weight with chain / poids avec chaîne /
peso con cadena / peso con catena

17.7012 Valve /Valve / Valva / Valve 25 x 38 mm

17.7022 Valve /Valve / Valva / Valve 25 x 44 mm



CLOWARD

17.8000 17 cm
 mit je 2 Valven 17.8002 - 17.8006
 with 2 ea. Valves 17.8002 - 17.8006
 avec 2 paires de valves 17.8002 - 17.8006
 con 2 valvas de c.u. Ref. 17.8002 - 17.8006
 con 2 valve ad innesto 17.8002 - 17.8006

17.8001 17 cm
 Sperrer allein
 Spreader only
 Ecarteur seul
 Separador suelto
 Divaricatore solo

stumpf
 blunt
 mousse
 romo
 smusso



CLOWARD
17.8002 40 mm



17.8003 45 mm



17.8004 50 mm



17.8005 55 mm



17.8006 60 mm

17.8007
 Satz mit 5 Valven 17.8002 - 17.8006
 Set of 5 Blades 17.8002 - 17.8006
 Jeu de 5 valves 17.8002 - 17.8006
 Juego de 5 valvas 17.8002 - 17.8006
 Serie di 5 valve 17.8002 - 17.8006

gezahnt
 serrated
 dentelé
 dentada
 dentate



CLOWARD

17.8010 25 cm
 mit je 2 Valven 17.8012 - 17.8016
 with 2 ea. Valves 17.8012 - 17.8016
 avec 2 paires de valves 17.8012 - 17.8016
 con 2 valvas de c.u. Ref. 17.8012 - 17.8016
 con 2 valve ad innesto 17.8012 - 17.8016

17.8011 25 cm
 Sperrer allein
 Spreader only
 Ecarteur seul
 Separador suelto
 Divaricatore solo



17.8012 40 mm



17.8013 45 mm



17.8014 50 mm



17.8015 55 mm



17.8016 60 mm

17.8017
 Satz mit 5 Valven 17.8012 - 17.8016
 Set of 5 Blades 17.8012 - 17.8016
 Jeu de 5 valves 17.8012 - 17.8016
 Juego de 5 valvas 17.8012 - 17.8016
 Serie di 5 valve 17.8012 - 17.8016



17.8042 45 x 35 mm
17.8043 45 x 45 mm
 spitz
 sharp
 pointu
 agudo
 acuto



17.8044 25 x 35 mm
17.8045 25 x 45 mm
 stumpf
 blunt
 mousse
 romo
 smusso

HOEN

17.8040 27 cm

mit 4 Valven 17.8042 - 17.8045
 with 4 blades 17.8042 - 17.8045
 avec 4 valves 17.8042 - 17.8045
 con 4 valvas 17.8042 - 17.8045
 con 4 valve 17.8042 - 17.8045

17.8041 27 cm

Sperrer allein / Spreader only
 Ecarteur seul
 Separador suelto / Divaricatore solo



17.8052
 50 mm



17.8053
 64 mm

CLOWARD-HOEN

17.8050 25 cm

mit je 2 Valven 17.8052, 17.8053
 with 2 ea. Valves 17.8052, 17.8053
 avec 2 paires de valves 17.8052, 17.8053
 con 2 valvas de c.u. Ref. 17.8052, 17.8053
 con 2 valve ad innesto 17.8052, 17.8053

17.8051 25 cm

Sperrer allein / Spreader only / Ecarteur seul
 Separador suelto / Divaricatore solo



MISKIMON
17.8060 21cm
32 x 35 mm

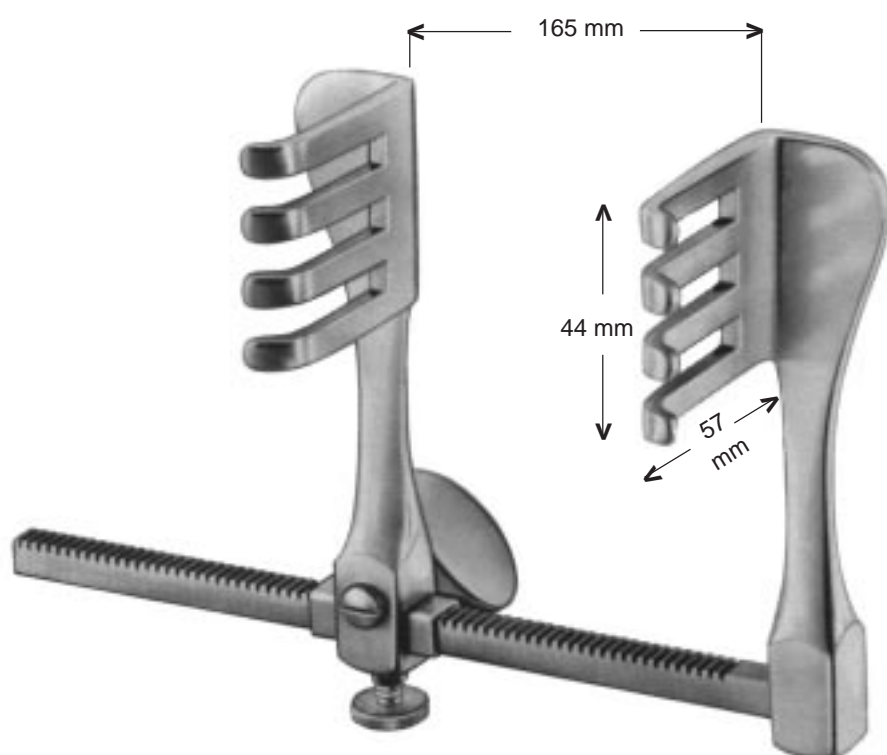

BADGLEY
17.8100



SCOVILLE-RICHTER

17.8130

bestehend aus:

- 17.8131 Rahmen, Spreizweite 14 cm
- 17.8132 Seitenvalve 3-zahnig 35 x 60 mm
- 17.8133 Seitenvalve 4-zahnig 50 x 60 mm

consisting of:

- 17.8131 Frame, spreading 14 cm
- 17.8132 Blade 3-prong, 35 x 60 mm
- 17.8133 Blade 4-prong, 50 x 60 mm

comprenant:

- 17.8131 Cadre, écartement 14 cm
- 17.8132 Valve à 3 dents 35 x 60 mm
- 17.8133 Valve à 4 dents 50 x 60 mm

compuesto de:

- 17.8131 Bastidor, extensión 14 cm
- 17.8132 Valva con 3 dientes 35 x 60 mm
- 17.8133 Valva con 4 dientes 50 x 60 mm

composto di:

- 17.8131 Telaio, apertura 14 cm
- 17.8132 valva con 3 denti, 35 x 60 mm
- 17.8133 valva con 4 denti, 50 x 60 mm

17.8131

Sperrer allein / Spreader only / Ecarteur seul / Separador
suelto / Divaricatore solo



SCOVILLE-RICHTER

17.8132 35x60 mm



17.8133 50x60 mm



17.8134 40x28 mm



17.8135 50x50 mm



17.8136 62x38 mm

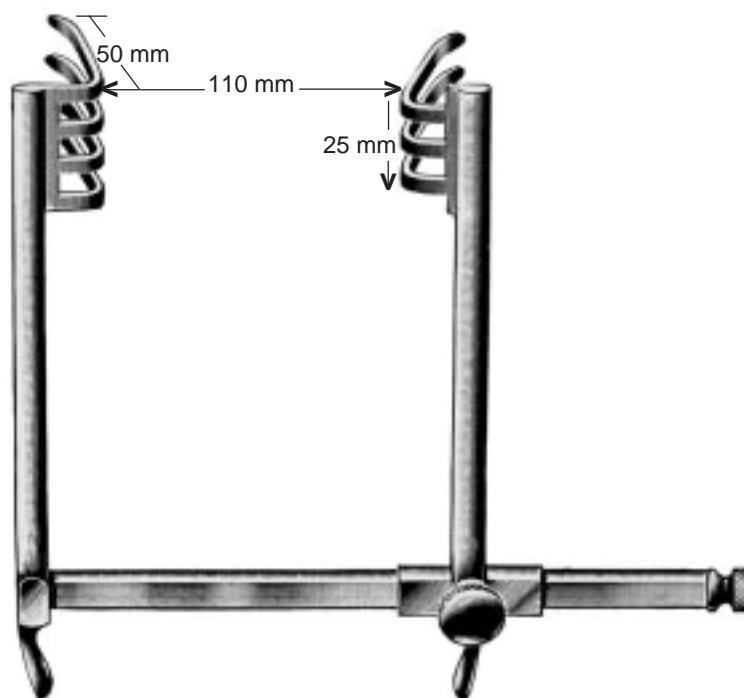

TEMPLE-FAY
17.8155



SCOVILLE

17.8161

bestehend aus:

17.8160 Rahmen, Spreizweite 15 cm

17.8172 Haken, stumpf 50 mm

17.8174 Valve gezahnt 64 x 24 mm

consisting of:

17.8160 Frame, spreading 15 cm

17.8172 blunt hook, 50 mm

17.8174 toothed blade 64 x 25 mm

comprenant:

17.8160 Cadre, écartement 15 cm

17.8172 Crochet mousse, 50 mm

17.8174 Valve dentelé 64 x 25 mm

compuesto de:

17.8160 Bastidor, extensión 15 cm

17.8172 Gancho romo, 50 mm

17.8174 Valva dentado 64 x 25 mm

composto di:

17.8160 Telaio, apertura 15 cm

17.8172 Uncino smusso 50 mm

17.8174 Valva dentato 64 x 25 mm

17.8160

Sperrer allein / Spreader only / Ecarteur seul /
Separador suelto / Divaricatore solo



SCOVILLE-HAVERFIELD

17.8164

bestehend aus:

- 17.8165 Rahmen mit Gelenk, Spreizweite 15 cm
- 17.8170 Haken, spitz 50 mm
- 17.8174 Valve gezahnt 64 x 24 mm

consisting of:

- 17.8165 Frame with joint, spreading 15 cm
- 17.8170 sharp hook, 50 mm
- 17.8174 toothed blade 64 x 25 mm

comprenant:

- 17.8165 Cadre avec articulation, écartement 15 cm
- 17.8170 Crochet pointu, 50 mm
- 17.8174 Valve dentelé 64 x 25 mm

compuesto de:

- 17.8165 Bastidor con articulación, extensión 15 cm
- 17.8170 Gancho agudo, 50 mm
- 17.8174 Valva dentado 64 x 25 mm

composto di:

- 17.8165 Telaio con articolazione, apertura 15 cm
- 17.8170 Uncino acuto 50 mm
- 17.8174 Valva dentato 64 x 25 mm

17.8165

Rahmen mit Gelenk Spreizweite 15 cm

Frame with joint, spreading 15 cm

Cadre avec articulation, écartement 15 cm

Bastidor con articulación, extension 15 cm

Telaio con acticolazione, apertura 15 cm



SCOVILLE

17.8170 50 mm

17.8171 75 mm

- spitz
- sharp
- pointu
- agudo
- acuto



SCOVILLE

17.8172 50 mm

17.8173 75 mm

- stumpf
- blunt
- mousse
- romo
- smusso



SCOVILLE

17.8174 64 x 25 mm

17.8175 64 x 50 mm

17.8177 88 x 25 mm



SCOVILLE

17.8178 41 x 38 mm

17.8179 67 x 44 mm



TAYLOR

17.8181 48 x 51 mm

17.8182 64 x 50 mm

17.8183 80 x 57 mm

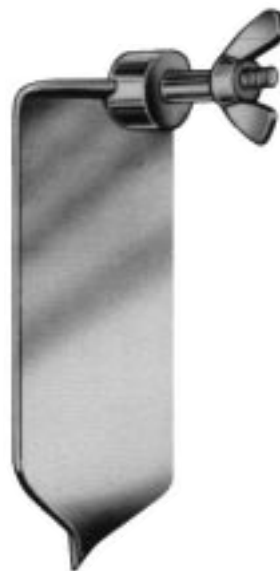

TAYLOR

17.8185 75 x 32 mm

17.8186 100 x 42 mm



HIBBS

17.8187 50 x 19 mm

17.8188 50 x 25 mm

17.8189 50 x 50 mm

17.8190 64 x 25 mm

17.8191 64 x 38 mm

17.8192 75 x 25 mm

17.8193 75 x 38 mm

17.8194 75 x 50 mm

17.8195 100 x 25 mm

17.8196 100 x 50 mm



MEYERDING

17.8201 50 x 25 mm

17.8203 75 x 25 mm

17.8205 90 x 50 mm

17.6542	MODULAR RETRAKTOR KIT II	
	bestehend aus:	Anzahl
17.6552	horizontale Stange	1
17.6554	Pfosten-Kupplung	1
17.6557	ovaler Rahmen 368 x 267 mm	1
17.6561	Spatel 51 x 152 mm biegsam	2
17.6562	Spatel 38 x 152 mm biegsam	1
17.6566	HARRINGTON Haken	1
17.6567	Spatel 72 x 152 mm biegsam	1
17.6568	KELLY Haken 51 x 76 mm	2
17.6569	KELLY Haken 51 x 102 mm	1
17.6570	KELLY Haken 51 x 127 mm	1
17.6571	KELLY Haken 51 x 152 mm	1
17.6576	BALFOUR Haken 67 x 76 mm	1
17.6577	GELPI Haken	1
17.6579	Standard Rasten	2
17.6580	Rasten schräg	6
17.6581	Tischpfosten	1
17.6582	Stange flexibel horizontal	1
17.6583	Rahmen geteilt 266 x 495 mm	1

17.6546	MODULAR REKTAL KIT	
	bestehend aus:	Anzahl
17.6584	runder Rahmen 216 mm	1
17.6585	Rektalvalve 73 mm lang	2
17.6586	Rektalvalve 98 mm lang	2

17.6547	MODULAR VAGINAL KIT	
	bestehend aus:	Anzahl
17.6554	PfostenKupplung	1
17.6580	Rasten schräg	4
17.6581	Tischpfosten	1
17.6582	Stange flexibel horizontal	1
17.6590	Vaginal Rahmen 203 x 266 mm	1
17.6591	MAGRINA Vaginal Haken 25 x 76 mm	1
17.6592	DEAVER Haken 25 x 89 mm	1
17.6593	DEAVER Haken 25 x 127 mm	1
17.6594	Vaginalhaken 25 x 114 mm	1

17.6578	MODULAR KIT FÜR KLEINE ERÖFFNUNGEN	
	bestehend aus:	Anzahl
17.6563	KELLY Spatel 51 x 51mm	1
17.6574	KELLY Haken 25 x 38 mm	1
17.6575	KELLY Haken 25 x 63 mm	1
17.6577	GELPI Haken	1
17.6584	runder Rahmen 216 mm	1

Sonderzubehör:

17.6553	Verlängerungsteil 305 mm
17.6556	ovaler Rahmen 267x470 mm
17.6558	ovaler Rahmen 203 x 311 mm
17.6559	runder Rahmen 266 mm
17.6560	runder Rahmen 317 mm
17.6565	KELLY Spatel 51 x 38 mm
17.6572	KELLY Haken 51 x 64mm
17.6587	Rahmen geteilt 216 x 356 mm
17.6588	Rahmen geteilt 317 x 495 mm
17.6635	Ring Segmente 216 mm (Paar)
17.6639	SCOVILLE Haken 50 mm
17.6640	SCOVILLE Haken 83 mm
17.6641	MEYERDING Haken 60x17 mm
17.6642	MEYERDING Haken 85x25 mm
17.6643	MEYERDING Haken 95x50 mm
17.6644	Haken 3-zahnig 19x17 mm
17.6645	Haken 4-zahnig 8x19 mm
17.6646	Haken 6-zahnig 8x25 mm

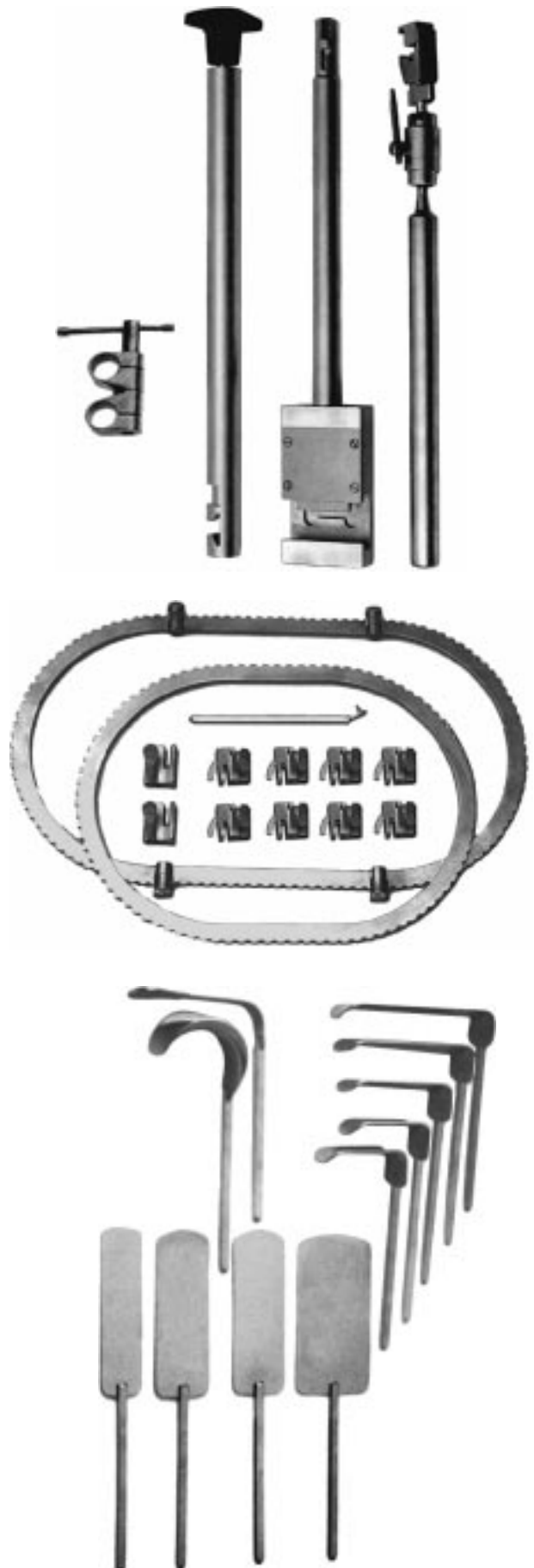

"MODULAR" RETRAKTOR-SYSTEM
"MODULAR" RETRACTOR SYSTEM
SYSTEME D'ECARTEUR "MODULAR"
SISTEMA SEPARADOR "MODULAR"
SISTEMA DIVARICATORE "MODULAR"

17.6542	MODULAR RETRACTOR KIT II	
	consisting of	Quantity
17.6552	Horizontal Bar	1
17.6554	Post Coupling	1
17.6557	Medium Oval Ring	1
17.6561	Spatulas mall. 152 x 51 mm	2
17.6562	"Spatula 6"" x 1 1/2"" malleable"	1
17.6566	HARRINGTON Retractor	1
17.6567	Spatula 72 x 152 mm malleable	1
17.6568	KELLY Retractor 51 x 76 mm	2
17.6569	KELLY Retractor 51 x 102 mm	1
17.6570	KELLY Retractor 51 x 127 mm	1
17.6571	KELLY Retractor 51 x 152 mm	1
17.6576	BALFOUR Blade 67 x 76 mm	1
17.6577	GELPI Point Blade	1
17.6579	Standard Ratchets	2
17.6580	Tilt Ratchets	6
17.6581	Table Post	1
17.6582	flexible Bar horizontal	1
17.6583	Segmented Ring 10 1/2 x 19 1/2"	1

17.6546	MODULAR RECTAL KIT	
	consisting of	Quantity
17.6584	Medium Round Ring 8 1/2" i.d"	1
17.6585	Rectal Blade 7/8" x 2 7/8"	2
17.6586	Rectal Blade 7/8" x 3 7/8"	2

17.6547	MODULAR VAGINAL KIT	
	consisting of	Quantity
17.6554	Post Coupling	1
17.6580	Tilt Ratchets	4
17.6581	Table Post	1
17.6582	flexible Bar horizontal	1
17.6590	Vaginal Retractor Ring 8 x 10 1/2"	1
17.6591	MAGRINA Vag. Retractor lateral blade	1
17.6592	DEAVER Blade 1"x 3 1/2"	1
17.6593	DEAVER Blade 1"x 5"	1
17.6594	DEAVER Blade 1"x 4 1/2"	1

17.6578	MODULAR SMALL INCISION KIT	
	consisting of	Quantity
17.6563	KELLY Spatula 2" x 2"	1
17.6574	KELLY Retractor 25 x 38 mm	1
17.6575	KELLY Retractor 25 x 63 mm	1
17.6577	GELPI Point Blade	1
17.6584	Medium Round Ring 8 1/2" i.d"	1

Optional accessories:

17.6553	Vertical Extension Bar 12"
17.6556	Large Oval Ring 12" x 18 1/2"
17.6558	Small Oval Ring 8" x 12 1/4"
17.6559	Medium Round Ring 10 1/2" i."
17.6560	Large Round Ring 12 1/2" i."
17.6565	KELLY Spatula 2" x 1 1/2"
17.6572	KELLY Retractor 51 x 64mm
17.6587	Segmented Ring 8 1/2 x 14"
17.6588	Segmented Ring 12 1/2 x 19 1/2"
17.6635	Ring Segments 8 1/2" (pair)"
17.6639	SCOVILLE Hook 2"
17.6640	SCOVILLE Hook 3 1/4"
17.6641	MEYERDING Hook 2 1/3" x 1/3"
17.6642	MEYERDING Hook 3 1/3" x 1"
17.6643	MEYERDING Hook 3 3/4" x 2"
17.6644	Hook 3 pr. 3/4" x 2/3"
17.6645	Hook 4 pr. 1/3" x 3/4"
17.6646	Hook 6 pr. 1/3" x 1"

17.6542	MODULAR ECARTEUR KIT II	
	comprenant:	quantité
17.6552	Pied horizontal	1
17.6554	Connecteur p. rallongement	1
17.6557	Cadre medium	1
17.6561	Spatules mall 152x51 mm	2
17.6562	Spatule 38 x 152 mm malleable	1
17.6566	HARRINGTON Ecarteur	1
17.6567	Spatule 72 x 152 mm malleable	1
17.6568	KELLY Ecartuer 51 x 76 mm	2
17.6569	KELLY Ecartuer 51 x 102 mm	1
17.6570	KELLY Ecarteur 51 x 127 mm	1
17.6571	KELLY Ecarteur 51 x 152 mm	1
17.6576	BALFOUR Ecartuer 67 x 76 mm	1
17.6577	GELPI Ecarteur	1
17.6579	Crémaillère standard	2
17.6580	Crémaillère oblique	6
17.6581	Pied de Table	1
17.6582	Bras flexible horizontal	1
17.6583	Cadre segmentaire 266 x 495	1

17.6546	MODULAR RECTAL KIT	
	comprenant:	quantité
17.6584	Cadre ronde 216 mm	1
17.6585	Valve rectale 73 mm	2
17.6586	Valve rectale 98 mm	2

17.6547	MODULAR VAGINAL KIT	
	comprenant:	quantité
17.6554	Connecteur p.rallongement	1
17.6580	Crémaillère oblique	4
17.6581	Pied de Table	1
17.6582	Bras flexible horizontal	1
17.6590	Cadre vaginal 203 x 266 mm	1
17.6591	MAGRINA Ecarteur vaginal latéral 25 x 76 mm	1
17.6592	DEAVER Valve 25 x 89 mm	1
17.6593	DEAVER Valve 25 x 127 mm	1
17.6594	Valve vginale 25 x 114 mm	1

17.6578	MODULAR BOITE POUR PETITES INCISIONS	
	comprenant:	quantité
17.6563	KELLY Spatule 51 x 51 mm	1
17.6574	KELLY Ecarteur 25 x 38 mm	1
17.6575	KELLY Ecarteur 25 x 63 mm	1
17.6577	GELPI Ecarteur	1
17.6584	Cadre ronde 216 mm	1

Accessoires optionels:

17.6553	Pièce/ rallongement 305 mm
17.6556	cadre oval 267 x 470 mm
17.6558	Cadre 203 x 311 mm
17.6559	Cadre ronde 266 mm
17.6560	Cadre ronde 317 mm
17.6565	KELLY Spatule 51 x 38 mm
17.6572	KELLY Ecarteur 51 x 64 mm
17.6587	Cadre segmentaire 216 x 356
17.6588	Cadre segmentaire 317 x 495
17.6635	Segment semi-circulaire Paire 216 mm
17.6639	SCOVILLE Crochet 50 mm
17.6640	SCOVILLE Crochet 83 mm
17.6641	MEYERDING Crochet 60x17 mm
17.6642	MEYERDING Crochet 85x25 mm
17.6643	MEYERDING Crochet 95x50 mm
17.6644	Crochet 3 dents 19x17 mm
17.6645	Crochet 4 dents 8x19 mm
17.6646	Crochet 6 dents 8x25 mm

17.6542	MODULAR SEPARADOR KIT II		
	compuesto de:		cantidad
17.6552	Poste horizontal	1	
17.6554	Connector p. empalme	1	
17.6557	Quadro medial	1	
17.6561	Espatulas mall.152x51 mm	2	
17.6562	Espatula 38 x 152 mm malleabl	1	
17.6566	HARRINGTON Separador	1	
17.6567	Espatula 72x152 mm malleable	1	
17.6568	KELLY Separador 51 x 76 mm	2	
17.6569	KELLY Separador 51 x 102 mm	1	
17.6570	KELLY Separador 51 x 127 mm	1	
17.6571	KELLY Separador 51 x 152 mm	1	
17.6576	BALFOUR Separador 67 x 76 mm	1	
17.6577	GELPI Separador	1	
17.6579	Cremallera standard	2	
17.6580	Cremallera obliquo	6	
17.6581	Poste vertical	1	
17.6582	Brazo flex. horizontal	1	
17.6583	Cuadro en segmentos 266 x 495 mm	1	
17.6546	MODULAR RECTAL KIT		
	compuesto de:		cantidad
17.6584	Quadro rondo 216 mm	1	
17.6585	Valva rectal 73 mm	2	
17.6586	Valva rectal 98 mm	2	
17.6547	MODULAR VAGINAL KIT		
	compuesto de:		cantidad
17.6554	Connector p. empalme	1	
17.6580	Cremallera obliquo	4	
17.6581	Poste vertical	1	
17.6582	Brazo flex. horizontal	1	
17.6590	Cuadro vaginal 203 x 266 mm	1	
17.6591	MAGRINA Separador vaginal lateral 25x76mm	1	
17.6592	DEAVER Valva 25 x 89 mm	1	
17.6593	DEAVER Valva 25 x 127 mm	1	
17.6594	Valva vaginal 25 x 114 mm	1	
17.6578	MODULAR KIT PARA INCISIONES PEQUENAS		
	compuesto de:		cantidad
17.6563	KELLY Espatula 51 x 51 mm	1	
17.6574	KELLY Separador 25 x 38 mm	1	
17.6575	KELLY Separador 25 x 63 mm	1	
17.6577	GELPI Separador	1	
17.6584	Quadro rondo 216 mm	1	

Accesorios opcionales:

17.6553	Pieza de empalme 305 mm
17.6556	Cuadro oval 267 x 470 mm
17.6558	Cuadro 203 x 311 mm
17.6559	Quadro rondo 266 mm
17.6560	Quadro rondo 317 mm
17.6565	KELLY Espatula 51 x 38 mm
17.6572	KELLY Separador 51 x 64 mm
17.6587	Cuadro en segmentos 216 x 356 mm
17.6588	Cuadro en segmentos 317 x 495 mm
17.6635	Segmento semi-circular (par) 216 mm
17.6639	SCOVILLE Gancho 50 mm
17.6640	SCOVILLE Gancho 83 mm
17.6641	MEYERDING Gancho 60x17 mm
17.6642	MEYERDING Gancho 85x25 mm
17.6643	MEYERDING Gancho 95x50 mm
17.6644	Gancho 3 dientes 19x17 mm
17.6645	Gancho 4 dientes 8x19 mm
17.6646	Gancho 6 dientes 8x25 mm

17.6542	MODULAR DIVARICATORE KIT II		
	composta da:		quantita
17.6552	Gambo orizzontale	1	
17.6554	Agganciamento di montante	1	
17.6557	Telaio ovale 368x267 mm	1	
17.6561	Spatola flessibile 152 x 51 mm	2	
17.6562	Spatola flessibile 389 x 152 mm	1	
17.6566	HARRINGTON Gancio	1	
17.6567	Spatola flessibile 72x152 mm	1	
17.6568	KELLY Gancio 51 x 76 mm	2	
17.6569	KELLY Gancio 51 x 102 mm	1	
17.6570	KELLY Gancio 51 x 127 mm	1	
17.6571	KELLY Gancio 51 x 152 mm	1	
17.6576	BALFOUR Gancio 67 x 76 mm	1	
17.6577	GELPI Gancio	1	
17.6579	Cremagliera standard	2	
17.6580	Cremagliera obliqua	6	
17.6581	Montante di tavola	1	
17.6582	Montane orizzontale flessibile	1	
17.6583	Telaio en segmentos 266 x 495 mm	1	
17.6546	MODULAR RECTAL KIT		
	composta da:		quantita
17.6584	Telaio mediano tondo 216 mm	1	
17.6585	Valva rettale 73 mm	2	
17.6586	Valva rettale 98 mm	2	
17.6547	MODULAR VAGINAL KIT		
	composta da:		quantita
17.6554	Agganciamento di montante	1	
17.6580	Cremagliera obliqua	4	
17.6581	Montante di tavola	1	
17.6582	Montane orizzontale flessibile	1	
17.6590	Telaio vaginal 203 x 266 mm	1	
17.6591	MAGRINA Gancio vaginal lateral 25x76mm	1	
17.6592	DEAVER Valva 25x89 mm	1	
17.6593	DEAVER Valva 25x127 mm	1	
17.6594	DEAVER Valva 25x114 mm	1	
17.6578	MODULAR KIT PER PICCOLE INCISIONE		
	composta da:		quantita
17.6563	KELLY Spatola 51 x 51 mm	1	
17.6574	KELLY Gancio 25 x 38 mm	1	
17.6575	KELLY Gancio 25 x 63 mm	1	
17.6577	GELPI Gancio	1	
17.6584	Telaio mediano tondo 216 mm	1	

Accessori opzionali:

17.6553	Gambo / prolunga verticale 305mm
17.6556	Telaio ovale 267x470 mm
17.6558	Telaio ovale 203x311 mm
17.6559	Telaio tondo 266 mm
17.6560	Telaio tondo 317 mm
17.6565	KELLY Spatola 51 x 38 mm
17.6572	KELLY Gancio 51 x 64 mm
17.6587	Telaio en segmenti 216 x 356 mm
17.6588	Telaio en segmenti 317 x 495 mm
17.6635	Segmenti semi-circular 216 mm (paio)
17.6639	SCOVILLE Gancio 50 mm
17.6640	SCOVILLE Gancio 83 mm
17.6641	MEYERDING Gancio 60 x 17 mm
17.6642	MEYERDING Gancio 85 x 25 mm
17.6643	MEYERDING Gancio 95 x 50 mm
17.6644	Gancio 3 denti 19 x 17 mm
17.6645	Gancio 4 denti 8 x 19 mm
17.6646	Gancio 6 denti 8 x 25 mm



27.1480

Laminektomiesperrer Aluminium
Laminectomy retractor only Aluminium
Ecarteur pour laminectomie Aluminium
Separador para laminectomia Aluminium
Divaricatore per laminectomia Aluminium

bestehend aus:

- 27.1481 Sperrer alleine
- 27.1485 - 2 Paar Valven 40 x 12 mm
- 27.1486 - 2 Paar Valven 50 x 12 mm
- 27.1487 - 2 Paar Valven 65 x 12 mm

consisting of:

- 27.1481 Retractor only
- 27.1485 - 2 pairs of valves 40 x 12 mm
- 27.1486 - 2 pairs of valves 50 x 12 mm
- 27.1487 - 2 pairs of valves 65 x 12 mm

comprenant:

- 27.1481 Ecarteur seul
- 27.1485 - 2 paires de valves 40 x 12 mm
- 27.1486 - 2 paires de valves 50 x 12 mm
- 27.1487 - 2 paires de valves 65 x 12 mm

compuesto de:

- 27.1481 Separador suelto
- 27.1485 - 2 pares valvas 40 x 12 mm
- 27.1486 - 2 pares valvas 50 x 12 mm
- 27.1487 - 2 pares valvas 65 x 12 mm

composta da:

- 27.1481 Separatore solo
- 27.1485 - 2 paia di valve 40 x 12 mm
- 27.1486 - 2 paia di valve 50 x 12 mm
- 27.1487 - 2 paia di valve 65 x 12 mm

27.1481

Sperrer allein / Spreader only / Ecarteur seul /
Separador suelto / Divaricatore solo

Ersatzvalven
Spare valves
Valves de rechange
Valvas di ricambio
Valve die ricambio



27.1485 40 x 12 mm

27.1486 50 x 12 mm

27.1487 65 x 12 mm

Paar
pair
paire
par
paio



CLOWARD

27.1451

16 cm

Spreizweite	15 mm
opening	15 mm
écartement	15 mm
abertura	15 mm
apertura	15 mm



CLOWARD

27.1455

13 cm

Spreizweite	20 mm
opening	20 mm
écartement	20 mm
abertura	20 mm
apertura	20 mm



INGE-BABY

17 cm

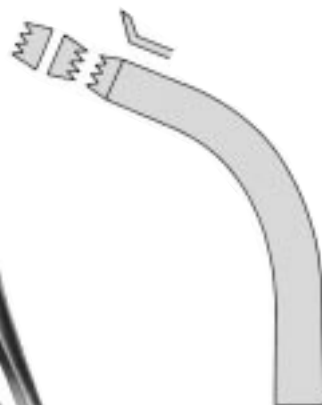

27.1460



27.1461



INGE
27 cm

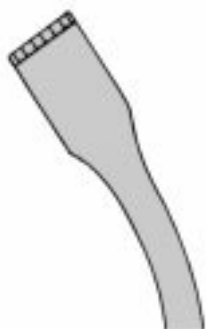

27.1465
9 mm



27.1466
12 mm



CASPAR

27.5050

Sperrer komplett mit 5 Valven 27.5062, 27.5072 - 27.5076
 Retractor complete with 5 blades 27.5062, 27.5072 - 27.5076
 Ecarteur complet avec 5 valves 27.5062, 27.5072 - 27.5076
 Separador completo con 5 valvas 27.5062, 27.5072 - 27.5076
 Divaricatore completo con 5 valve 27.5062, 27.5072 - 27.5076

27.5051

Sperrer allein / retractor only / ecarteur seul
 separador solamente / divaricatore solo



27.5062 38 mm



27.5063 58 mm



- 27.5071** 32 x 22 mm
- 27.5072** 37 x 22 mm
- 27.5073** 43 x 22 mm
- 27.5074** 47 x 22 mm
- 27.5075** 52 x 22 mm
- 27.5076** 57 x 22 mm
- 27.5077** 62 x 22 mm
- 27.5078** 67 x 22 mm



- 27.5081** 32 x 37 mm
- 27.5082** 37 x 37 mm
- 27.5083** 43 x 37 mm
- 27.5084** 47 x 37 mm
- 27.5085** 52 x 37 mm
- 27.5086** 57 x 37 mm
- 27.5087** 62 x 37 mm
- 27.5088** 67 x 37 mm



- 27.5091** 32 x 52 mm
- 27.5092** 37 x 52 mm
- 27.5093** 43 x 52 mm
- 27.5094** 47 x 52 mm
- 27.5095** 52 x 52 mm
- 27.5096** 57 x 52 mm
- 27.5097** 62 x 52 mm
- 27.5098** 67 x 52 mm



CASPAR

17 cm

27.5000

Sperrer komplett mit 7 Valven 27.5021 - 27.5027

Retractor complete with 7 blades 27.5021 - 27.5027

Ecarteur complet avec 7 valves 27.5021 - 27.5027

Separador completo con 7 valvas 27.5021 - 27.5027

27.5001

Sperrer allein / retractor only

ecarteur seul / separador solamente

27.5021 40 mm



27.5022 45 mm



27.5023 50 mm



27.5024 55 mm



27.5025 60 mm



27.5026 65 mm



27.5027 70 mm





CASPAR
27.5100

Sperrer komplett mit 5 Valven 27.5183 - 27.5187
 Retractor complete with 5 blades 27.5183 - 27.5187
 Ecarteur complet avec 5 valves 27.5183 - 27.5187
 Separador completo con 5 valvas 27.5183 - 27.5187
 Divaricatore completo con 5 valve 27.5183 - 27.5187

27.5101

Sperrer allein / retractor only
 ecarteur seul / separador solamente / divaricatore solo



CASPAR
27.5110

Sperrer komplett mit 5 Valven 27.5183 - 27.5187
 Retractor complete with 5 blades 27.5183 - 27.5187
 Ecarteur complet avec 5 valves 27.5183 - 27.5187
 Separador completo con 5 valvas 27.5183 - 27.5187
 Divaricatore completo con 5 valve 27.5183 - 27.5187

27.5111

Sperrer allein / retractor only
 ecarteur seul / separador solamente / divaricatore solo



CASPAR
27.5120

Cervicalsperrer mit je 1 Valve
 27.5132 - 27.5136; 27.5152 - 27.5156

Cervical Retractor complete with 1 ea. Valve
 27.5132 - 27.5136; 27.5152 - 27.5156

Ecarteur cervical complet avec 1 chacun
 27.5132 - 27.5136; 27.5152 - 27.5156

Separador cervical completo con 1 c/u
 27.5132 - 27.5136; 27.5152 - 27.5156

Divaricatore completo con 1 ciascuno
 27.5132 - 27.5136; 27.5152 - 27.5156

27.5121

Sperrer allein / retractor only
 ecarteur seul / separador solamente /
 Divaricatore solo

**SPERRER FÜR DIE CERVICALE WIRBELSÄULE
RETRACTORS FOR CERVICAL VERTEBRAL COLUMN
ECARTEURS POUR COLONNE CERVICALE
SEPARADORES PARA LA COLUMNA CERVICAL
DIVARICATORI PER COLONNA CERVICALE**

Valven für CASPAR Sperrer
Blades for CASPAR retractors
Valves pour écarteurs CASPAR
Valvas para separadores CASPAR
Valve per divaricatore CASPAR



CASPAR TITANIUM

- 27.5122 40 x 25 mm
- 27.5123 45 x 25 mm
- 27.5124 50 x 25 mm
- 27.5125 55 x 25 mm
- 27.5126 60 x 25 mm

MEDIAL



CASPAR

- 27.5152 40 x 23 mm
- 27.5153 45 x 23 mm
- 27.5154 50 x 23 mm
- 27.5155 55 x 23 mm
- 27.5156 60 x 23 mm

LATERAL



CASPAR

- 27.5132 40 x 23 mm
- 27.5133 45 x 23 mm
- 27.5134 50 x 23 mm
- 27.5135 55 x 23 mm
- 27.5136 60 x 23 mm

MEDIAL



CASPAR

- 27.5164 50 x 25 mm
- 27.5166 60 x 25 mm



CASPAR TITANIUM

- 27.5142 40 x 25 mm
- 27.5143 45 x 25 mm
- 27.5144 50 x 25 mm
- 27.5145 55 x 25 mm
- 27.5146 60 x 25 mm

LATERAL



CASPAR

- 27.5183 45 x 23 mm
- 27.5184 50 x 23 mm
- 27.5185 55 x 23 mm
- 27.5186 60 x 23 mm
- 27.5187 65 x 23 mm



CASPAR

- 27.5199
- Pinzette zum Blattwechsel
- Forceps for changing valves
- Pince pour changer les valves
- Pinza para cambiari valvas
- Pinza per cambiare valve



27.5401 45 mm
 27.5402 50 mm
 27.5403 55 mm
 27.5404 60 mm
 27.5405 65 mm



modifiziertes Model
 improved model
 modèle modifié
 modelo modificado
 modello modific.

CASPAR
 27.5401 - 27.5405



CASPAR

27.5440

Gegensperrer komplett bestehend aus:

27.5441 Gegensperrer
 27.5430 - 27.5435 6 Valven 35, 40, 45, 50, 55, 60 mm

Counter-Retractor complete, consisting of:

27.5441 Counter Retractor
 27.5430 - 27.5435 6 Blades 35, 40, 45, 50, 55, 60 mm

Contre-Écarteur complet, comprenant:

27.5441 Contre-Écarteur
 27.5430 - 27.5435 6 valves 35, 40, 45, 50, 55, 60 mm

Contra-Separador completo, compuesto de:

27.5441 Contra-separador
 27.5430 - 27.5435 6 valvas 35, 40, 45, 50, 55, 60 mm

Contra-Divaricatore completo, composta da:

27.5441 Contre-divaricatore
 27.5430 - 27.5435 6 valve 35, 40, 45, 50, 55, 60 mm

CASPAR

27.5441

Gegensperrer alleine / Counter-Retractor only

Contre-Écarteur seul / Contra-Separador suelto

Contra-Divaricatore solo

WUNDSPREIZER ZUR MIKRODISKEKTOMIE
RETRACTORS FOR MICRO-LUMBAR DISCECTOMY
ECARTEURS POUR LA MICRO-DISQUECTOMIE LOMBAIRE
SEPARADORES PARA LA MICRODISCECTOMIA LOMBAR
DIVARICATORI PER LA MICRO DISCECTOMIA LOMBARE



CASPAR



27.5030 45 mm



27.5031 50 mm



27.5032 55 mm



27.5033 60 mm



27.5034 65 mm



CASPAR

27.5420

Sperrer komplett mit 6 Valven 27.5430 - 27.5435
 Retractor complete with 6 blades 27.5430 - 27.5435
 Ecarteur complet avec 6 valves 27.5430 - 27.5435
 Separador completo con 6 valvas 27.5430 - 27.5435
 Divaricatore completo con 6 valve 27.5430 - 27.5435

27.5421

Sperrer allein / retractor only
 ecarteur seul / separador solamente / divaricatore solo

27.5430 35 mm



27.5431 40 mm



27.5432 45 mm



27.5433 50 mm



27.5434 55 mm



27.5435 60 mm



27.5436 65 mm



27.5437 75 mm



27.5438 85 mm





CASPAR

27.5500

Wirbelkörperdistraktor für Operationen an unterer und mittlerer Halswirbelsäule von rechts, bestehend aus:

- 27.5501 Distraktor
- 27.5509 Bohrlehre rechts
- 27.5520 Bohrer
- 27.5536 Distraktionsschrauben 16 mm (2 St.)
- 27.5550 Schraubendreher

Vertebral body distractor for surgical procedures of the cervical spine, from the right, consisting of:

- 27.5501 Distractor
- 27.5509 Drillguide, right
- 27.5520 Twist Drill
- 27.5536 Distraction screws 16 mm (2 pcs.)
- 27.5550 Screwdriver

Distracteur des corps vertébraux pour la chirurgie de la colonne cervicale, accès du côté droite, comprenant:

- 27.5501 Distracteur
- 27.5509 Guide-forets, droite
- 27.5520 Foret
- 27.5536 Vis à distraction 16 mm (2 pcs.)
- 27.5550 Tourne-vis

Distractor de los cuerpos vertebrales para la cirugía de la columna cervical, acceso del lado derecho, compuesto de:

- 27.5501 Distractor
- 27.5509 Guia para brocas, a la derecha
- 27.5520 Perforador
- 27.5536 Tornillos para distracción 16 mm (2 pzas.)
- 27.5550 Destornillador

Distrattore die corpi vertebrali per la chirurgia della colonna cervicale, acceso del lato destro, composta da:

- 27.5501 Distrattore
- 27.5509 Guide di perforatori, destra
- 27.5520 Perforatore
- 27.5536 Viti di distrazione 16 mm (2 pezzi)
- 27.5550 Cacciavite

27.5501

Distraktor alleine / Distractor only / Distracteur seul /
Distractor suelto / Distrattore solo



27.5509

Bohrlehre, links für 27.5500
Drill Guide, left for 27.5500
Guide-forets, gauche pour 27.5500
Guia para brocas, a la izquierda para 27.5500
Guide di perforatori, sinistra - per 27.5500



27.5519

Bohrlehre, rechts für 27.5510
Drill Guide, right for 27.5510
Guide-forets, droite pour 27.5510
Guia para brocas, a la derecha para 27.5510
Guide di perforatori, destra - per 27.5510



CASPAR

27.5510

Wirbelkörperdistraktor für Operationen an unterer und mittlerer Halswirbelsäule von links, bestehend aus:

- 27.5511 Distraktor
- 28.5519 Bohrlehre links
- 27.5520 Bohrer
- 27.5536 Distraktionsschrauben 16 mm (2 St.)
- 27.5500 Schraubendreher

Vertebral body distractor for surgical procedures of the cervical spine, from the left, consisting of:

- 27.5511 Distractor
- 28.5519 Drillguide, right
- 27.5520 Twist Drill
- 27.5536 Distraction screws 16 mm (2 pcs.)
- 27.5500 Screwdriver

Distracteur des corps vertébraux pour la chirurgie de la colonne cervicale, accès du côté gauche, comprenant:

- 27.5511 Distracteur
- 28.5519 Guide-forets, gauche
- 27.5520 Foret
- 27.5536 Vis à distraction 16 mm (2 pcs.)
- 27.5500 Tourne-vis

Distractor de los cuerpos vertebrales para la cirugía de la columna cervical, acceso del lado izquierdo, compuesto de:

- 27.5511 Distractor
- 28.5519 Guia para brocas, a la izquierda
- 27.5520 Perforador
- 27.5536 Tornillos para distracción 16 mm (2 pzas.)
- 27.5500 Destornillador

Distrattore die corpi vertebrali per la chirurgia della colonna cervicale, acceso del lato sinistro, composta da:

- 27.5511 Distrattore
- 28.5519 Guide di perforatori, sinistra
- 27.5520 Perforatore
- 27.5536 Viti di distrazione 16 mm (2 pezzi)
- 27.5500 Cacciavite

27.5511

Distraktor alleine / Distractor only / Distracteur seul /
Distractor suelto / Distrattore solo



Bohrer
Drill
Mèche
Broca
Perforatore

CASPAR

27.5520

14,5 cm / 1,7 mm



Distraktionsschraube
Distraction screw
Vis à distraction
Tornillo para distracción
Viti di distrazione

CASPAR

27.5532 12 mm

27.5534 14 mm

27.5536 16 mm

27.5538 18 mm



Schraubenzieher
Screwdriver
Tourne-vis
Destornillador
Giravite

CASPAR

27.5550 20 cm



27.0700

LEYLA Retraktor Set 1-Arm
LEYLA Retractor Set 1-arm
LEYLA Ecarteur Jue 1-bras
LEYLA Separador Juego 1-brazo
LEYLA Divaricatore Set 1-braccio

bestehend aus:

27.0705 flexibler Spannarm
27.0706 Fixiervorrichtung für 1 Spannarm
27.0709 Spatelhalterung für flache Spateln

consisting of:

27.0705 flexible arm
27.0706 fixation base for 1 flexible arm
27.0709 support for flat spatulas

comprenant:

27.0705 bras tendeur flexibles
27.0706 étau crânien pour 1 bras flexible
27.0709 porte-spatules plates

compuesto de:

27.0705 brazo flexible
27.0706 dispositivo a fijación 1 brazo flexible
27.0709 soporte para espátulas llanas

composto da:

27.0705 braccio flessibile solo
27.0706 Fissatore per 1 braccio al cranio
27.0709 Sostegno per spatole piatte

27.0701

LEYLA Retraktor 2-Arme
LEYLA Retractor Set 2-arms
LEYLA Ecarteur Jue 2-bras
LEYLA Separador Juego 2-brazos
LEYLA Divaricatore Set 2-bracci

bestehend aus:

27.0705 2 flexible Spannarme
27.0707 1 Fixiervorrichtung für 2 Spannarme
27.0709 2 Spatelhalterungen für flache Spateln

consisting of:

27.0705 2 flexible arms
27.0707 1 fixation base for 2 flexible arms
27.0709 2 supports for flat spatulas

comprenant:

27.0705 2 bras tendeur flexibles
27.0707 1 étau crânien pour 2 bras flexibles
27.0709 2 portes-spatules plates

compuesto de:

27.0705 2 brazos flexibles
27.0707 1 dispositivo a fijación 2 brazos flexibles
27.0709 2 soportes para espátulas llanas

composto da:

27.0705 2 bracci flessibili
27.0707 1 Fissatore per bracci flessibili al cranio
27.0709 2 Sostegni per spatole piatte



27.0702

LEYLA Retraktor System zum Fixieren am OP-Tisch
 LEYLA Retractor System for fixation to Operating table
 LEYLA Ecarteur Système pour attacher à la table d'opération
 LEYLA Separador Sistema para fijar sobre la mesa de operaciones
 LEYLA Divaricatore Sistema per fissare all' tavolo operatorio

bestehend aus:

- 27.0705 LEYLA Spannarm allein
- 27.0709 LEYLA Flachspatelhalter
- 27.0711 LEYLA Haltearm starr
- 27.0712 LEYLA Kupplungskopf zur Aufnahme von 1 - 5 Spannarmen
- 27.0713 LEYLA Kugelgelenkkloben zum Befestigen des Haltearms am OP-Tisch
- 27.1031 HIRNSPATEL 200 / 9 mm
- 27.1032 HIRNSPATEL 200 / 12 mm

consisting of:

- 27.0705 LEYLA flexible arm only
- 27.0709 LEYLA Support f. flat Spatulas
- 27.0711 LEYLA Holding Rod rigid
- 27.0712 LEYLA coupling head for 1 - 5 flexible arms
- 27.0713 LEYLA Ball-and -socket joint for attaching Rod to operating table
- 27.1031 BRAIN SPATULA 200 / 9 mm
- 27.1032 BRAIN SPATULA 200 / 12 mm

comprenant:

- 27.0705 LEYLA bras tendeur flexible
- 27.0709 LEYLA porte-spatule pour spatules plats
- 27.0711 LEYLA potence, rigide
- 27.0712 LEYLA tete porte-bras pour 1 - 5 bras tendeur
- 27.0713 LEYLA Piéce de fixation pour attacher le bras à la table d'opération
- 27.1031 SPATULE cérébrale 200 / 9 mm
- 27.1032 SPATULE cérébrale 200 / 12 mm

compuesto de:

- 27.0705 LEYLA brazo flexible
- 27.0709 LEYLA porta-espátulas para espátulas planos
- 27.0711 LEYLA brazo rigido
- 27.0712 LEYLA cabeza porta-brazos para 1 - 5 brazos flexibles
- 27.0713 LEYLA Mecanismo para fijar el brazo sobre la mesa de operaciones
- 27.1031 ESPATULA cerebrale 200 / 9 mm
- 27.1032 ESPATULA cerebrale 200 / 12 mm

composto da:

- 27.0705 LEYLA braccio flessibile
- 27.0709 LEYLA Sostegno per spatole piatte
- 27.0711 LEYLA Braccio di fissaggio
- 27.0712 LEYLA Pezzo al combinare 1 - 5 bracci
- 27.0713 LEYLA Meccanismo per fissare il braccio all' tavolo operatorio
- 27.1031 SPATOLA cerebrale 200 / 9 mm
- 27.1032 SPATOLA cerebrale 200 / 12 mm

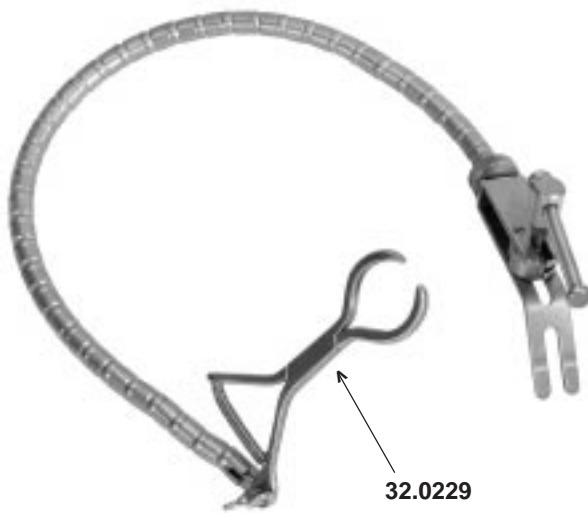

32.0220

LEYLA Ohrspekulahalter komplett
LEYLA Ear specula holder complete
LEYLA tendeur de spéculums auriculaires
LEYLA porta-especulos auriculares compl.
LEYLA Portaspecoli auricolari completo

32.0229

Ohrtrichterhalter
Ear specula holder
Tendeur de spéculums
Porta-especulos auriculares
Pinza portaspecoli auricolari

bestehend aus:

27.0705 LEYLA Spannarm allein
27.0708 LEYLA Fixiervorrichtung für Rohrteile
32.0229 LEYLA Ohrstrichterhalter

consisting of:

27.0705 LEYLA flexible arm only
27.0708 LEYLA Fixation base for mounting to bars
32.0229 LEYLA Ear specula holder

comprenant:

27.0705 LEYLA bras tendeur flexible
27.0708 LEYLA etau cranien simple pour attacher à potence etc.
32.0229 LEYLA Tendeur de spéculums

compuesto de:

27.0705 LEYLA brazo flexible
27.0708 LEYLA dispositivo a fijación al brazo rígido
32.0229 LEYLA Porta-especulos auriculares

composto da:

27.0705 LEYLA braccio flessibile
27.0708 LEYLA Fissatore per 1 braccio al braccio
32.0229 LEYLA Pinza portaspecoli

27.0705

LEYLA Spannarm
flexible arm
Bras tendeur flexible
Brazo flexible
Braccio flessibile



27.0706

LEYLA Fixiervorrichtung für 1 Spannarm
fixation base for 1 flexible arm
étau crânien pour 1 bras flexible
dispositivo a fijación 1 brazo flexible
Fissatore per 1 braccio al cranio



27.0707

LEYLA Fixiervorrichtung für 2 Spannarme
fixation base for 2 flexible arms
étau crânien pour 2 bras flexibles
dispositivo a fijación 2 brazos flexibles
Fissatore per 2 bracci al cranio



27.0708

Fixiervorrichtung für 1 Spannarm 27.0705 zum Befestigen an Rohrteilen
Fixation base for 1 flexible arm 27.0205 for attaching to round bars
Pièce de fixation pour 1 bras 27.0205 aux tiges rondes
Fijador para 1 brazo 27.0705 para fijar al tubos
Fissatore per 1 braccio 27.0705 per il fissare al bracci rotondo



27.0709

LEYLA Flachspatelhalter
support for flat spatulas
porte-spatules plates
soporte para espátulas llanas
Sostegno per spatole piatte



27.0710

LEYLA Rundspatelhalter
support for round spatulas
porte-spatules pour spatules ronds
porta-espátulas para espátulas rondos
Sostegno per spatole con asta rotonda



- 27.0711** LEYLA Haltearm starr
Holding Rod rigid
Potence, rigide
Brazo rigido
Braccio rigido



- 27.0712** Kupplungskopf zur Aufnahme von 1 - 5 Spannarmen 27.0705
Coupling head for 1-5 flexible arms 27.0705
tête porte-bras pour 1 - 5 bras tendeur 27.0705
cabeza porta-brazos para 1-5 brazos flexibles 27.0705
Pezzo al combinare 1 - 5 bracci 27.0705



- 27.0713** Kugelgelenkkolben zum Befestigen des Haltearms 27.0711 am OP-Tisch
Ball-and -socket joint for attaching Rod 27.0711 to operating table
Pièce de fixation pour attacher le bras 27.0711 à la table d'opération
Mecanismo para fijar el brazo 27.0711 sobre la mesa de operaciones
Meccanismo per fissare il braccio 27.0711 all' tavolo operatorio



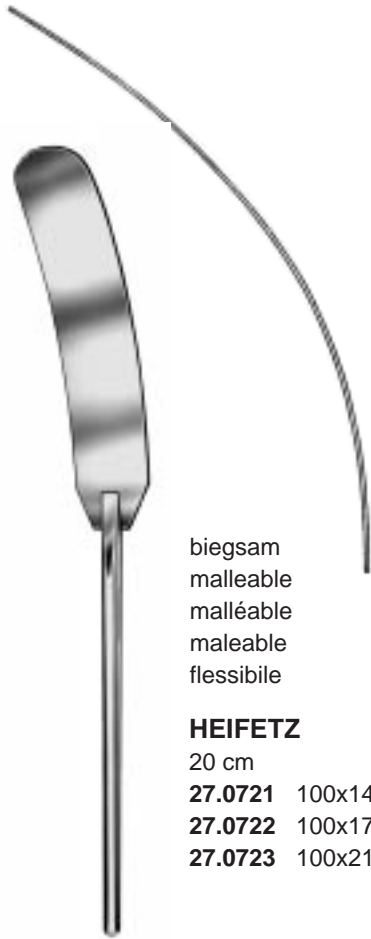

biegsam
 malleable
 malléable
 maleable
 flessibile

HEIFETZ

20 cm

27.0721 100x14 mm

27.0722 100x17 mm

27.0723 100x21 mm

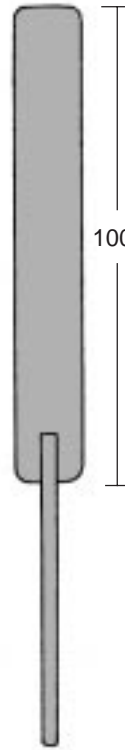

100 mm

biegsam
 malleable
 malléable
 maleable
 flessibile

HEIFETZ

20 cm

27.1026 8 mm

27.1027 11 mm

27.1028 14 mm

27.1029 17 mm



"AACHEN"

20 cm

27.1041 7/ 8 mm

27.1042 10/11 mm

27.1043 13/14 mm

27.1044 16/17 mm

27.1045 19/20 mm

27.1046 22/25 mm



DAVIS

18 cm

27.1050 6,0 mm

27.1051 9,5 mm

27.1052 13,5 mm

27.1053 16,0 mm

27.1054 19,0 mm

27.1055 25,0 mm

27.1056 32,0 mm

27.1057 38,0 mm



SCOVILLE

20 cm

27.1060 10/13 mm

27.1061 16/19 mm

biegsam / malleable / malléable / maleable / flessibile



27.1031 200 x 9 mm
27.1032 200 x 12 mm
27.1033 250 x 12 mm

biegsam
 malleable
 malléable
 maleable
 flessibile



27.1034 "MEMORY" 200 x 9 mm
27.1035 "MEMORY" 200 x 12 mm
27.1036 "MEMORY" 200 x 14 mm
27.1037 "MEMORY" 200 x 18 mm
27.1038 "MEMORY" 200 x 20 mm
27.1039 "MEMORY" 200 x 25 mm

biegsame "MEMORY"-Legierung
 malleable "MEMORY" alloy
 alliage flexible "MEMORY"
 aleación flexible "MEMORY"
 lega flessibile "MEMORY"



OLIVECRONA

konkav / concave
 concave / cóncavas
 concave

18 cm

27.1000 7 x 9 mm
27.1001 11 x 13 mm
27.1002 15 x 18 mm
27.1003 18 x 22 mm



OLIVECRONA

konvex / convex
 convexe / convexas
 convesse

18 cm

27.1005 7 x 9 mm
27.1006 11 x 13 mm
27.1007 15 x 18 mm
27.1008 18 x 22 mm



CUSHING

27.1010

17 cm 8 x 10 mm

27.1012

20 cm 13 x 15 mm



40.0670

a	b	c	d
55 mm	100 mm	170 mm	130 mm

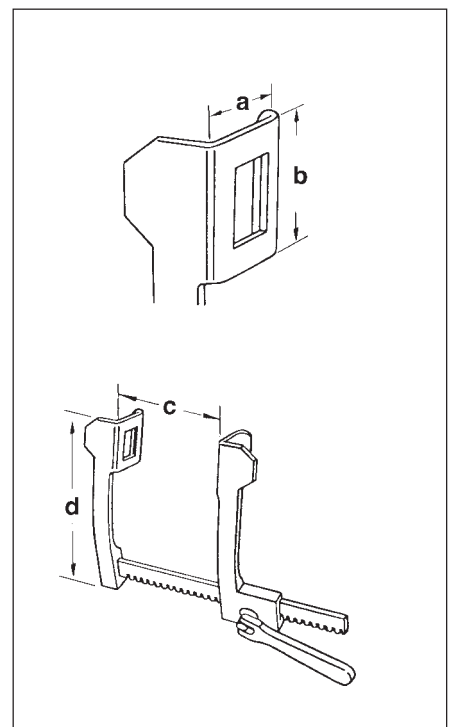



MATHIEU
48.1030
19,5 cm

ALAN-PARKS

48.1050 15 cm
komplett
complete
complet
completo

48.1051
Sperrer allein
retractor only
ecarteur seul
separador solamente
divaricatore solo

48.1054
95x24 mm
Mittelvalve alleine
Center blade only
Valve centrale aeul
Valva central solomenta
Valva centrale solo



48.1052
75 x 24 mm



48.1053
95 x 24 mm



75 x 23 mm

SMITH-BUIE
48.1060 15 cm



70 x 22 mm

BARR
48.1070 17 cm



ST. MARKS
48.1080 22 cm



MILLIN
51.0020
28 cm



MILLIN
51.0080

komplett, mit 2 Seitenvalven 57x25 mm und 80x25 mm, 1 Mittelvale 120x45 mm
complete, with 2 lateral valves 57x25 mm and 80x25 mm, 1 center blade 120x45 mm
complet, avec 2 valves latérales 57x25 mm et 80x25 mm, 1 valve centrale 120x45 mm
completo, con 2 valvas laterales 57x25 mm y 80x25 mm, 1 valva central 120x45 mm
completo, con 2 valve laterali 57x25 mm e 80x25 mm, 1 valva centrale 120x45 mm



JUDD-MASSON
51.0070

Spreizweite 100 mm
spread 100 mm
ouverture 100 mm
apertura 100 mm
apertura 100 mm



JUDD-MASSON
51.0072

komplett, mit 2 Seitenvalven 70x25 mm und 1 Mittelvalve 84x24 mm
 complete, with 2 lateral valves 70x25 mm and 1 center blade 84x24 mm
 complet, avec 2 valves latérales 70x25 mm et 1 valve centrale 84x24 mm
 completo, con 2 valvas laterales 70x25 mm y 1 valva central 84x24 mm
 completo, con 2 valve laterali 70x25 mm e 1 valva centrale 84x24 mm



THOMSON-WALKER
51.0090

komplett, mit 2 Seitenvalven 70x25 mm und 75x25 mm, 1 Mittelvalve 90x25 mm
 complete, with 2 lateral valves 70x25 mm and 75x25 mm, 1 center blade 90x25 mm
 complet, avec 2 valves latérales 70x25 mm et 75x25 mm, 1 valve centrale 90x25 mm
 completo, con 2 valvas laterales 70x25 mm y 75x25 mm, 1 valva central 90x25 mm
 completo, con 2 valve laterali 70x25 mm e 75x25 mm, 1 valva centrale 90x25 mm



HRYNTSCHAK
51.0098

Rahmen allein
 Frame only
 Cadre seul
 Bastidor solo
 Telaio solo

HRYNTSCHAK
51.0099

Mittelvalve 35x100mm
 Center blade 35x100mm
 Valve centrale 35x100mm
 Valva central 35x100mm
 Valva centrale 35x100mm

HRYNTSCHAK
51.0097

Spreizweite 110 mm
 spread 110 mm
 ouverture 110 mm
 apertura 110 mm
 apertura 110 mm



KOGAN
55.0530 24 cm



KOGAN
55.0532 24 cm



LATERAL
55.0550
22 cm
