

NEUROCHIRURGIE
NEUROSURGERY
NEUROCHIRURGIE
NEUROCIURUGIA
NEUROCHIRURGIA

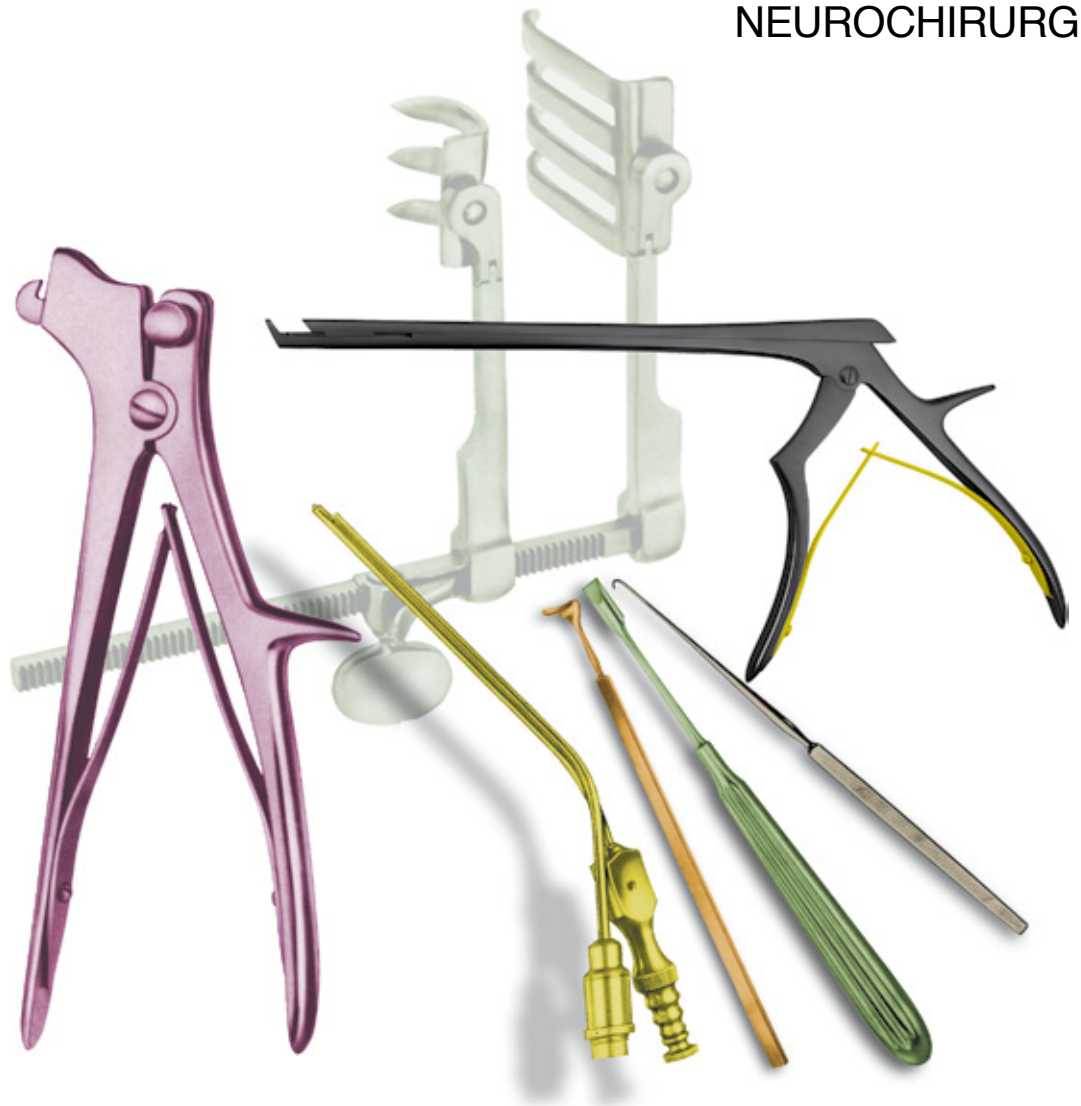

27.0003	3 Fr.	14,5 cm
27.0004	4 Fr.	14,5 cm
27.0005	5 Fr.	14,5 cm
27.0006	6 Fr.	14,5 cm
27.0007	7 Fr.	14,5 cm
27.0008	8 Fr.	14,5 cm
27.0009	9 Fr.	14,5 cm
27.0010	10 Fr.	14,5 cm
27.0011	11 Fr.	14,5 cm
27.0012	12 Fr.	14,5 cm
27.0013	3 Fr.	16,0 cm
27.0014	4 Fr.	16,0 cm
27.0015	5 Fr.	16,0 cm
27.0016	6 Fr.	16,0 cm
27.0017	7 Fr.	16,0 cm
27.0018	8 Fr.	16,0 cm
27.0019	9 Fr.	16,0 cm
27.0020	10 Fr.	16,0 cm
27.0021	11 Fr.	16,0 cm
27.0022	12 Fr.	16,0 cm
27.0023	3 Fr.	18,0 cm
27.0024	4 Fr.	18,0 cm
27.0025	5 Fr.	18,0 cm
27.0026	6 Fr.	18,0 cm
27.0027	7 Fr.	18,0 cm
27.0028	8 Fr.	18,0 cm
27.0029	9 Fr.	18,0 cm
27.0030	10 Fr.	18,0 cm
27.0031	11 Fr.	18,0 cm
27.0032	12 Fr.	18,0 cm
27.0033	3 Fr.	21,5 cm
27.0034	4 Fr.	21,5 cm
27.0035	5 Fr.	21,5 cm
27.0036	6 Fr.	21,5 cm
27.0037	7 Fr.	21,5 cm
27.0038	8 Fr.	21,5 cm
27.0039	9 Fr.	21,5 cm
27.0040	10 Fr.	21,5 cm
27.0041	11 Fr.	21,5 cm
27.0042	12 Fr.	21,5 cm



FUKUSHIMA
27.0003 - 27.0042

biegsam / malleable / malléable /
maleable / malleabile

SAUGKANÜLEN
 ASPIRATING CANNULAE
 CANULES D'ASPIRATION
 CANULAS PARA ASPIRACION
 CANNULE PER ASPIRAZIONE



ADSON
 27.0056
 21 cm / 4 mm
 Charr. / Fr. 12



ADSON
 27.0057
 21 cm / 4 mm
 Charr. / Fr. 12



FRAZIER
 27.0066 10 cm / 2,0 mm
 27.0067 10 cm / 2,5 mm
 27.0068 10 cm / 3,0 mm

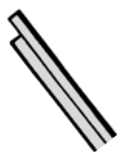

27.0070
 1,8 + 1,8 mm

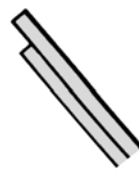

27.0071
 2,5 + 2,0 mm

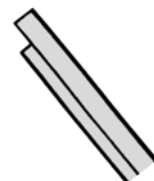

27.0072
 3,0 + 2,0 mm



HOUSE
 18 cm

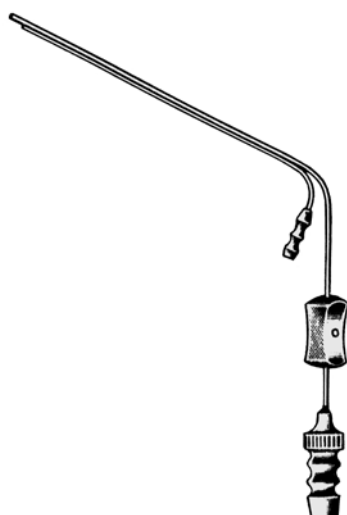

HOUSE
 27.0073 9 cm / 0,9 + 0,7 mm
 27.0074 9 cm / 1,2 + 0,9 mm
 27.0075 9 cm / 1,5 + 1,2 mm



FISCH
 27.0076 9 cm / 1,8 + 1,8 mm
 27.0077 9 cm / 2,5 + 2,0 mm
 27.0078 9 cm / 3,0 + 2,0 mm
 27.0079 9 cm / 4,5 + 2,0 mm



27.0094
 Ø 0,4 mm



27.0096
 Ø 0,6 mm



27.0098
 Ø 0,8 mm



WULLSTEIN

27.0090 Mikro-Absaugrohr komplett, bestehend aus:
 27.0091 Saugerhandgriff 14 cm
 27.0094 Mikro-Saugkanüle 0,4 mm Ø
 27.0096 Mikro-Saugkanüle 0,6 mm Ø
 27.0098 Mikro-Saugkanüle 0,8 mm Ø

Micro-canule aspiratrice complète, comprenant:
 27.0091 Manche pour canule d'aspiration
 27.0094 Micro Canule aspiratrice 0,4 mm Ø
 27.0096 Micro Canule aspiratrice 0,6 mm Ø
 27.0098 Micro Canule aspiratrice 0,8 mm Ø

Micro-suction tube complete, consisting of:
 27.0091 Suction handle
 27.0094 Micro Suction Canula 0,4 mm Ø
 27.0096 Micro Suction Canula 0,6 mm Ø
 27.0098 Micro Suction Canula 0,8 mm Ø

Micro-Tubo de aspiración completo, compuesto de:
 27.0091 Mango para cánula de aspiración
 27.0094 Micro Canula de aspiración 0,4 mm Ø
 27.0096 Micro Canula de aspiración 0,6 mm Ø
 27.0098 Micro Canula de aspiración 0,8 mm Ø

Adapter
 Adapter
 Adapteur
 Adaptor
 Adattatore Luer / Luer

Micro-Tubo completo, composto di:
 27.0091 Manico d'aspirazione
 27.0094 Tubo aspirazione 0,4 mm Ø
 27.0096 Tubo aspirazione 0,6 mm Ø
 27.0098 Tubo aspirazione 0,8 mm Ø



HOUSE
 27.0089

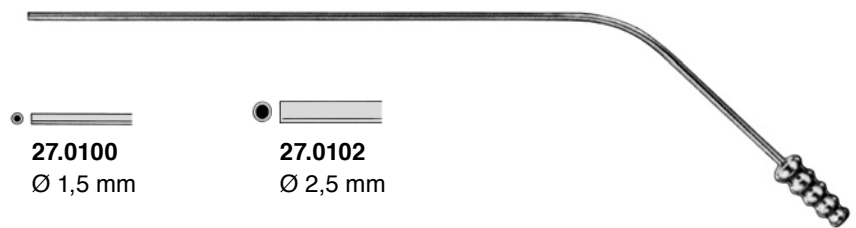

27.0100
 Ø 1,5 mm

27.0102
 Ø 2,5 mm

27.0101
 Ø 2,0 mm

27.0103
 Ø 3,5 mm

YASARGILL
 150 mm

**SAUGKANÜLEN
ASPIRATING CANNULAE
CANULES D'ASPIRATION
CANULAS PARA ASPIRACION
CANNULE PER ASPIRAZIONE**

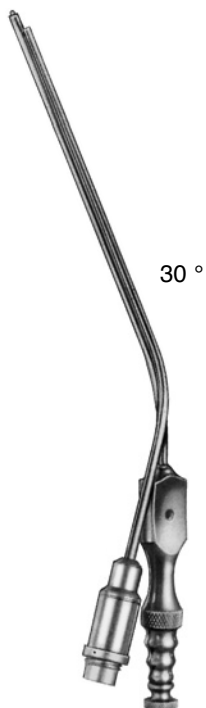

30 °

FRAZIER

18 cm

27.0152 8 Fr. 30°

27.0154 10 Fr. 30°

27.0156 12 Fr. 30°

mit Wolf, Storz, ACMI Kaltlicht-Anschluß

with Fiber Optic connectors Wolf, Storz, ACMI

lumière froide avec connecteurs pour Wolf, Storz, ACMI

Luz fria con connexion Wolf, Storz, ACMI

illuminazione alogena con attacco Wolf, Storz, ACMI



30 °

FRAZIER

18 cm

27.0170 6 Fr. 30°

27.0171 7 Fr. 30°

27.0172 8 Fr. 30°

27.0173 9 Fr. 30°

27.0174 10 Fr. 30°

27.0175 11 Fr. 30°

27.0176 12 Fr. 30°

27.0179 15 Fr. 30°

**E = isoliert
insulated
isolée
aislante
isolato**

27.0170E

27.0171E

27.0172E

27.0173E

27.0174E

27.0175E

27.0176E

27.0179E



75 °

FERGUSON

18 cm

27.0180 6 Fr. 30°

27.0181 7 Fr. 30°

27.0182 8 Fr. 30°

27.0183 9 Fr. 30°

27.0184 10 Fr. 30°

27.0185 11 Fr. 30°

27.0186 12 Fr. 30°

27.0187 15 Fr. 30°

**E = isoliert
insulated
isolée
aislante
isolato**

27.0180E

27.0181E

27.0182E

27.0183E

27.0184E

27.0185E

27.0186E

27.0187E



FRAZIER

18 cm

27.0190 6 Fr. 30°

27.0191 7 Fr. 30°

27.0192 8 Fr. 30°

27.0193 9 Fr. 30°

27.0194 10 Fr. 30°

27.0195 11 Fr. 30°

27.0196 12 Fr. 30°

**E = isoliert
insulated
isolée
aislante
isolato**

27.0190E

27.0191E

27.0192E

27.0193E

27.0194E

27.0195E

27.0196E

27.0199

Reinigungsdraht für Frazier / Ferguson Kanülen

Cleaning Stylet for Frazier / Ferguson

Tige à nettoyage pour Frazier / Ferguson

Alambre-limpieza para Frazier / Ferguson

Filo per pulire Frazier / Ferguson



PLESTER

32.1166

19,5 cm 1,5 mm Ø

32.1167

19,5 cm 2,0 mm Ø

32.1168

19,5 cm 2,5 mm Ø

32.1169

19,5 cm 3,0 mm Ø

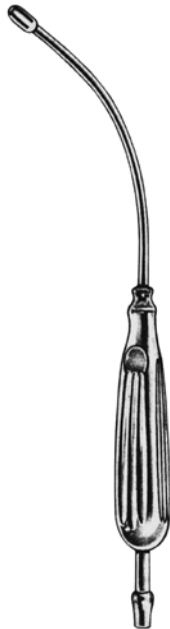

ANDREW-PYNCHON

19.0700 24 cm

Ø 6 mm



COUPLAND

33.1160 26 cm

mit 2 Ansätzen
 with 2 tips
 avec 2 embouts
 con 2 puntas
 con 2 punte
 1,5 / 2,0 mm Ø

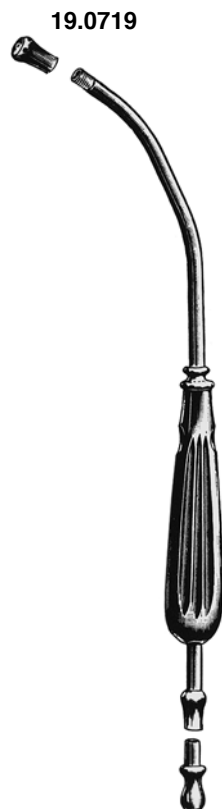

YANKAUER

19.0710 27 cm

19.0711 36 cm

19.0712 40 cm

19.0713 46 cm

Ø 10 mm

komplett

complete

complet

completo

19.0718



mit Absperrventil u. abschraubbarem Rohr
 with stopcock and removeable tube
 avec robinet et canule demontable
 con llave y tubo desmontable
 con interruttore e tubo svitabile

YANKAUER

19.0715 33 cm

Ø 10 mm



HUDSON
27.0209



27.0202
9 mm Ø



27.0203
14 mm Ø



27.0204
16 mm Ø



27.0205
22 mm Ø

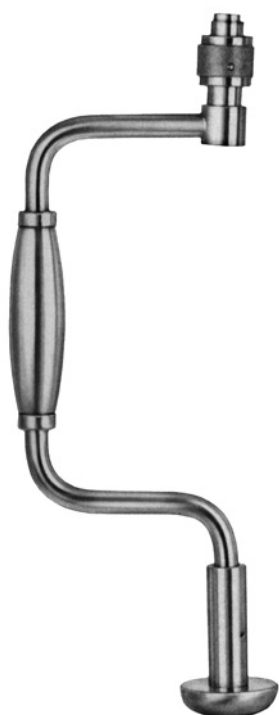

HUDSON
27.0200

Handbohrapparat mit Fräsern 27.0202 bis 27.0205 und Verlängerungsstück 27.0209

Hand drill with 4 burrs 27.0202 - 27.0205 and extension piece 27.0209

Vilebrequin a main avec Fraises 27.0202 - 27.0205 et rallonge 27.0209

Perforador de mano, con 4 fresas 27.0202 - 27.0205 y pieza de prolongación 27.0209

Trepano a mano, completo, con frese 27.0202 - 27.0205 e giunto di prolungamente 27.0209

27.0201

Bohrwinde / hand drill / Vilebrequin seul / Perforador de mano suelto / Trepano a mano solo



CUSHING
27.0206
14 mm Ø



McKENZIE
27.0207
14 mm Ø



D'ERRICO
27.0208
14 mm Ø



ADSON
27.0212
2 mm Ø



GIGLI
27.0520

27.0521

Paar / pair / paire / par / paio

Einführungsinstrument für Drahtsägen
 Conductor for wire saws
 Conducteur pour scies
 Conductor para sierras de hilo
 Guida per fili per sege

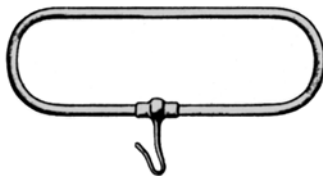

GIGLI
27.0525



OLIVECRONA (GIGLI)

27.0530 30 cm

27.0531 40 cm

27.0532 50 cm

27.0533 60 cm

27.0534 70 cm



MARTEL

27.0540 33 cm
gerade / straight
droit / recta / retto

27.0541 33 cm
gebogen / curved
courbe / curva / curvo

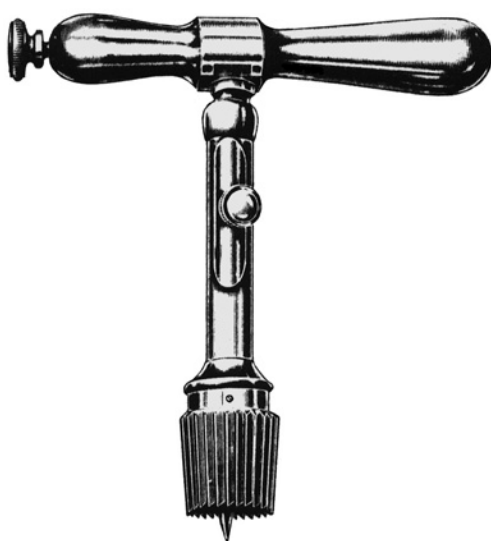

GALT

27.0600 13 mm Ø

27.0601 16 mm Ø

27.0602 19 mm Ø

27.0603 22 mm Ø

27.0604 25 mm Ø

Trephinen
 Trephines
 Tréphines
 Trepanos
 Trefine

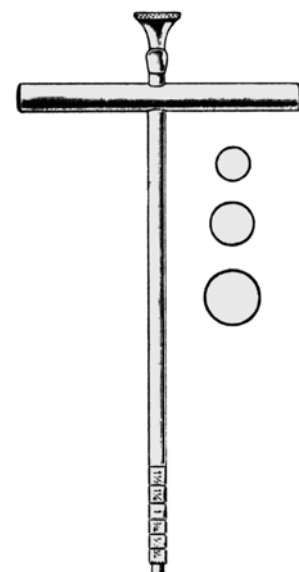

MICHELE

27.0610 5,0 mm Ø

27.0611 5,5 mm Ø

27.0612 8,0 mm Ø

**SCHÄDELHALTER
CERVICAL TRACTION TONGS
PINCES DE TRACTION CRANIENNE
PINZAS PARA TRACCION CRANEAL
PINZE PER TRAZIONE CRANIALE**

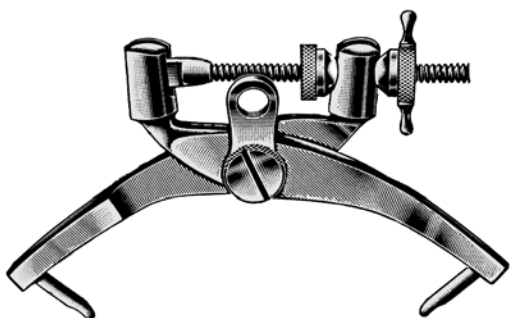

CRUTCHFIELD
27.0400 11 cm

kleines Modell / small pattern / modèle petit /
modelo pequeño / modello piccolo



CRUTCHFIELD
27.0402 13 cm

mittleres Modell / medium model / modèle moyen /
modèle mediano / modello medio

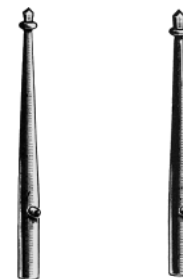

27.0408 **27.0409**
3,5 mm Ø 5 mm Ø

Vorbohrer / drill points
Alésoirs / Perforadores
Alesatori



großes Modell
large pattern
Modèle grand
modelo grande
modello grande

CRUTCHFIELD
27.0430

Schädelhalter für Halswirbelextension
for extension of the neck vertebrae
pour tractions cervicales
para la extensión de las vertebrae de cuello
per trazione craniale e l'estensione per vertebra del collo



27.0438

11 / 14 mm

Schraubenschlüssel / wrench / clef / llave inglesa / chiave

27.0439

Ersatzdorn / Spare pin / Broches de rechange / Punta de
reposito suelta / Punto di ricambio

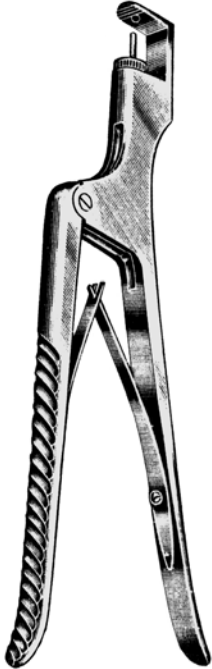

CONE
27.0500
19 cm / 7 mm
27.0502
23 cm / 12 mm



DEVILBIS
27.0510
21 cm



DAHLGREN
27.0515
20 cm

MESSER, DISSEKTOREN, ELEVATOREN
 KNIVES, DISSECTORS; ELEVATORS
 COUTEAUX, DISSECTEURS, ELEVATEURS
 BISTURIES, DISECADORES, ELEVADORES
 COLTELLI, DISSETORI, ELEVATORI



HALLE
27.0960
 20 cm

Unterbindungsnadel
 Ligature Needle
 Aiguille à ligatures
 Aguja para ligaduras
 Agho per legature

Elevatoren / Elevators / Elévateurs / Elevadores / Elevatori



ADSON
 17 cm

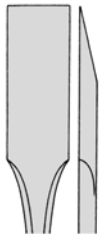

27.0800

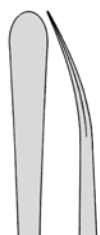

27.0801

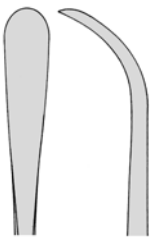

27.0802

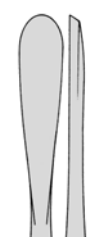

27.0803



HOEN-MARTIN



27.0810
 16 cm / 7 mm

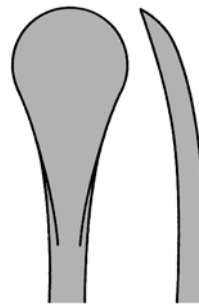

27.0811
 19 cm / 15 mm

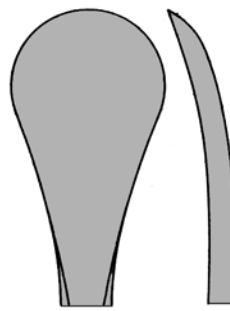

27.0812
 19 cm / 20 mm



ADSON
27.0860
 23 cm

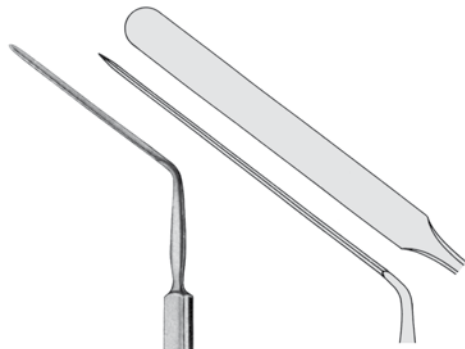

HORSELY
27.0870
19 cm



FRAZIER
27.0880
15 cm



HOEN
27.0890
15 cm 45°



HOEN
27.0891
15 cm 90°

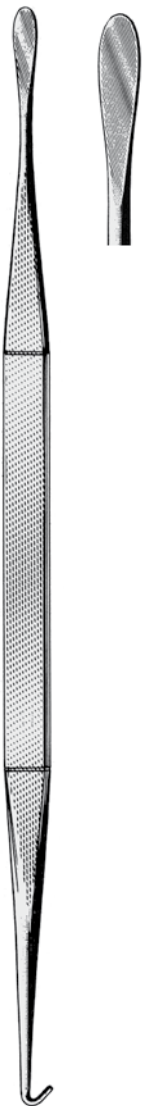

SMITHWICK
27.0900
29 cm

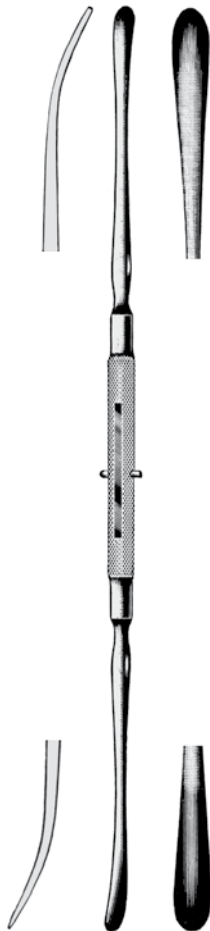

DAVIS
27.0910
24,5 cm



DAVIS
27.0912
19 cm



PENFIELD
27.0921
17,5 cm #1

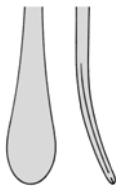

PENFIELD
27.0922
19,5 cm #2

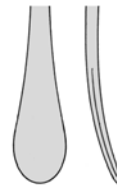

PENFIELD
27.0923
19,5 cm #3

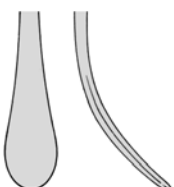

PENFIELD
27.0924
21,5 cm #4



PENFIELD
27.0925
29 cm #5



SCHARFE LÖFFEL, SPINALHAKEN, HÄKCHEN
 BONE CURETTES, SPINAL HOOKS, NERVE HOOKLETS
 CURETTES TRANCHANTES, ECARTEURS SPINAUX, CROCHETS POUR NERFS
 CUCHILLAS CORTANTES, SEPARADORES ESPINALES, GANCHOS PARA NERVIOS
 CURETTE TAGLIENTI, DIVARICATORI SPINALI, UNCINI PER NERVI

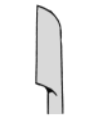

27.1100



27.1101



27.1102

SCOVILLE
25 cm



000
27.1105



00
27.1106



0
27.1107

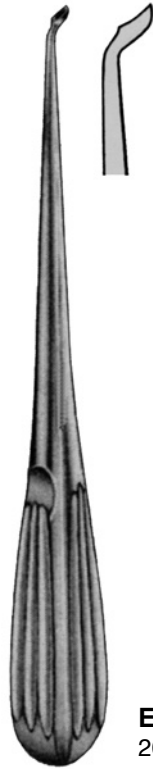

EPSTEIN
20 cm



TAYLOR
27.1150
75 x 30 mm
27.1152
100 x 30 mm



CLOWARD
27.1160
76 x 13 mm
27.1161
76 x 18 mm
27.1162
76 x 20 mm
27.1163
76 x 23 mm



27.1201
90°



27.1202
45°

CRILE
20 cm



HOEN
27.1206
22 cm



ADSON
27.1210 20 cm
spitz / sharp
pointu / agudo / acuto



ADSON
27.1211 20 cm
stumpf / blunt
mousses / romo / smusso

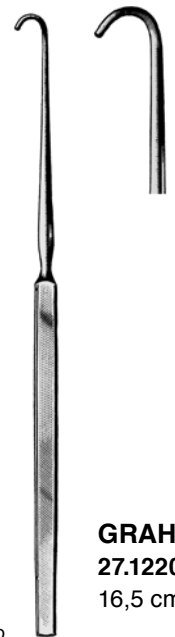

GRAHAM
27.1220
16,5 cm



SACHS
27.1222
18 cm

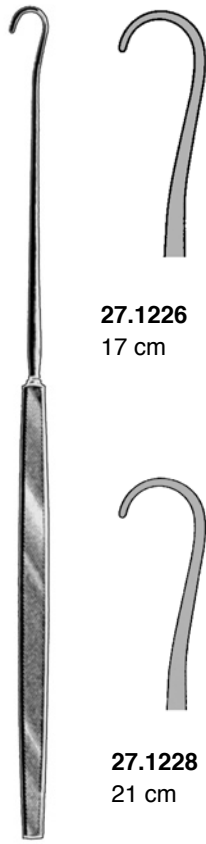

SMITHWICK

27.1226
17 cm

27.1228
21 cm



DANDY
27.1230
20 cm



DANDY
27.1231
20 cm



DANDY
27.1232
20 cm



CUSHING
27.1240
19 cm / 5 mm
27.1245
28 cm / 5 mm



CUSHING
27.1241
19 cm / 8 mm
27.1246
28 cm / 8 mm

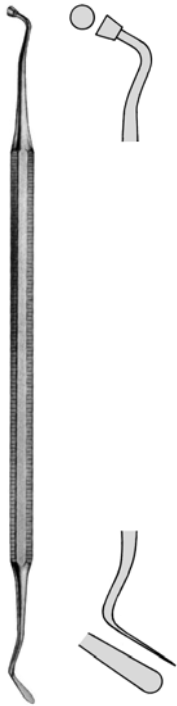

WOODSON
 27.1296
 18 cm



LAHEY
 27.1305
 13 cm



FRAZIER



27.1310
 13 cm
 spitz
 sharp
 pointu
 agudo



27.1311
 13 cm
 stumpf
 blunt
 mousse
 romo



27.1312
 18 cm
 spitz
 sharp
 pointu
 agudo



27.1313
 18 cm
 stumpf
 blunt
 mousse
 romo



CUSHING
 27.1320
 14 cm



CUSHING
 27.1325
 14 cm



CLOWARD
 27.1330
 16,5 cm



TOENNIS
 27.1340
 15 cm

NERVHAKEN
NERVE HOOKS
CROCHETS A NERFS
GANCHOS, SEPARADORES PARA NERVIOS
UNCINI, DIVARICATORI PER NERVI

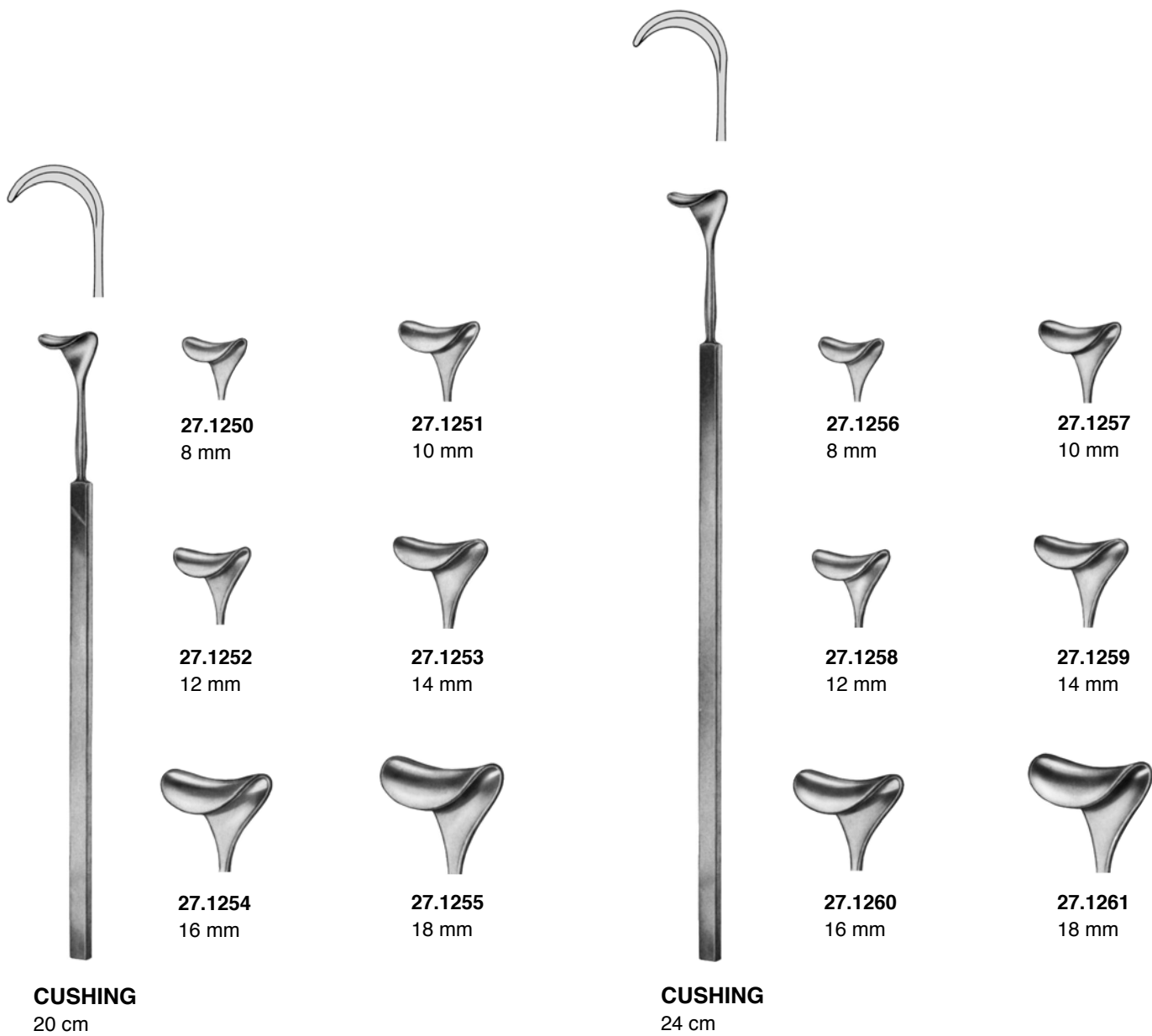



SCOVILLE
27.1390
 23 cm / 8 mm

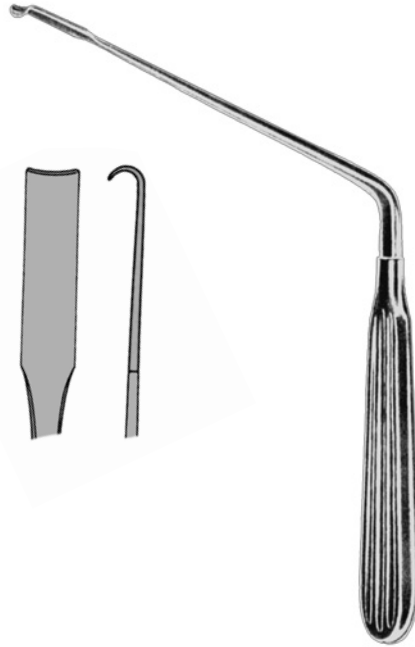

SCOVILLE
27.1391
 23 cm / 8 mm

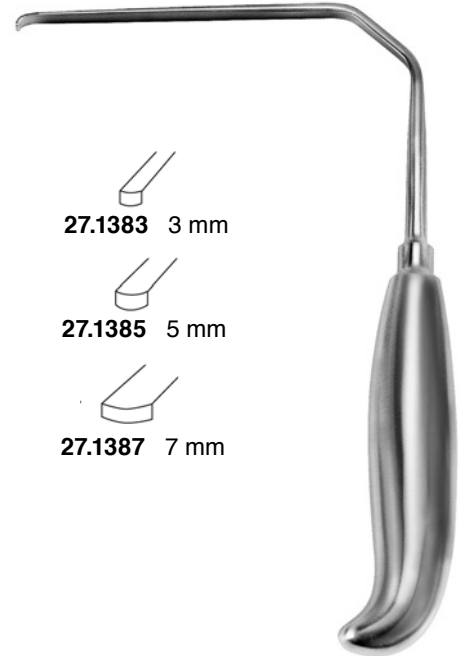

27.1383 3 mm
27.1385 5 mm
27.1387 7 mm

HESS
 17,5 cm



LOVE
27.1400
 19 cm/7 mm

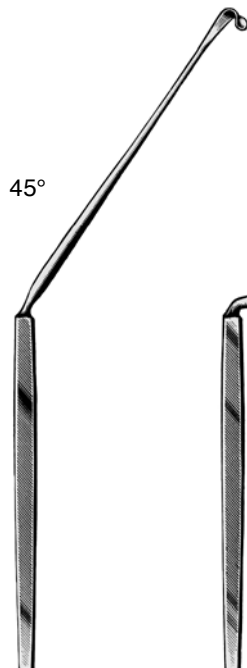

LOVE
27.1402
 18 cm/7 mm

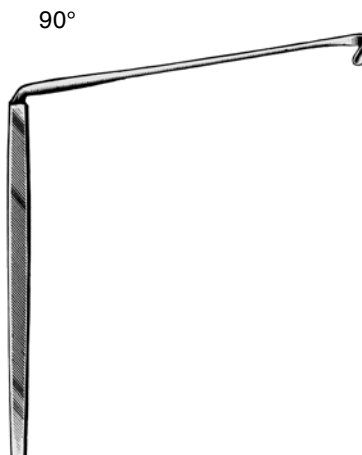

LOVE
27.1404
 11 cm/7 mm



LOVE
27.1406
 21 cm

NERVHAKEN
NERVE HOOKS
CROCHETS A NERFS
GANCHOS, SEPARADORES PARA NERVIOS
UNCINI, DIVARICATORI PER NERVI



CASPAR

27.1394 24 cm / 4 mm
27.1396 24 cm / 6 mm
27.1398 24 cm / 8 mm
27.1399 24 cm / 10 mm



SCOVILLE

27.1410
30,5 cm



SCOVILLE

27.1412
30,5 cm

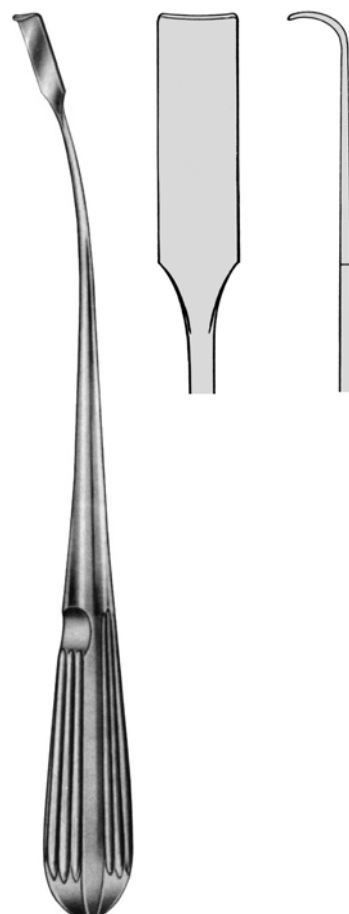

HOLSHER

27.1413
25 cm / 7 mm



CUSHING
27.1420
20 cm



D'ERRICO
27.1425
23 cm



OLDBERG
20 cm

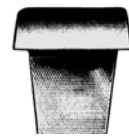

27.1430



27.1431



27.1432



27.1433



27.0700

LEYLA Retraktor Set 1-Arm
LEYLA Retractor Set 1-arm
LEYLA Ecarteur Jue 1-bras
LEYLA Separador Juego 1-brazo
LEYLA Divaricatore Set 1-braccio

bestehend aus:

27.0705 flexibler Spannarm
27.0706 Fixiervorrichtung für 1 Spannarm
27.0709 Spatelhalterung für flache Spateln

consisting of:

27.0705 flexible arm
27.0706 fixation base for 1 flexible arm
27.0709 support for flat spatulas

comprenant:

27.0705 bras tendeur flexibles
27.0706 étau crânien pour 1 bras flexible
27.0709 porte-spatules plates

compuesto de:

27.0705 brazo flexible
27.0706 dispositivo a fijación 1 brazo flexible
27.0709 soporte para espátulas llanas

composto da:

27.0705 braccio flessibile
27.0706 Fissatore per 1 braccio al cranio
27.0709 Sostegno per spatole piatte

27.0701

LEYLA Retraktor 2-Arme
LEYLA Retractor Set 2-arms
LEYLA Ecarteur Jue 2-bras
LEYLA Separador Juego 2-brazos
LEYLA Divaricatore Set 2-bracci

bestehend aus:

27.0705 2 flexible Spannarme
27.0707 1 Fixiervorrichtung für 2 Spannarme
27.0709 2 Spatelhalterungen für flache Spateln

consisting of:

27.0705 2 flexible arms
27.0707 1 fixation base for 2 flexible arms
27.0709 2 supports for flat spatulas

comprenant:

27.0705 2 bras tendeur flexibles
27.0707 1 étau crânien pour 2 bras flexibles
27.0709 2 portes-spatules plates

compuesto de:

27.0705 2 brazos flexibles
27.0707 1 dispositivo a fijación 2 brazos flexibles
27.0709 2 soportes para espátulas llanas

composto da:

27.0705 2 bracci flessibili
27.0707 1 Fissatore per bracci flessibili al cranio
27.0709 2 Sostegni per spatole piatte



27.0702

LEYLA Retraktor System zum Fixieren am OP-Tisch

LEYLA Retractor System for fixation to Operating table

LEYLA Ecarteur Système pour attacher à la table d'opération

LEYLA Separador Sistema para fijar sobre la mesa de operaciones

LEYLA Divaricatore Sistema per fissare al tavolo operatorio

bestehend aus:

27.0705 LEYLA Spannarm allein

27.0709 LEYLA Flachspatelhalter

27.0711 LEYLA Haltearm starr

27.0712 LEYLA Kupplungskopf zur Aufnahme von
1 - 5 Spannarmen

27.0713 LEYLA Kugelgelenkkloben zum Befestigen
des Haltearms am OP-Tisch

27.1031 SPATEL 200 / 9 mm

27.1032 SPATEL 200 / 12 mm

consisting of:

27.0705 LEYLA flexible arm only

27.0709 LEYLA Support f. flat Spatulas

27.0711 LEYLA Holding Rod rigid

27.0712 LEYLA coupling head for 1 - 5 flexible arms

27.0713 LEYLA Ball-and -socket joint for attaching
Rod to operating table

27.1031 SPATULA 200 / 9 mm

27.1032 SPATULA 200 / 12 mm

comprenant:

27.0705 LEYLA bras tendeur flexible

27.0709 LEYLA porte-spatule pour spatules plats

27.0711 LEYLA potence, rigide

27.0712 LEYLA tete porte-bras pour 1 - 5 bras tendeur

27.0713 LEYLA Pièce de fixation pour attacher le bras
à la table d'opération

27.1031 SPATULE 200 / 9 mm

27.1032 SPATULE 200 / 12 mm

compuesto de:

27.0705 LEYLA brazo flexible

27.0709 LEYLA porta-espátulas para espátulas planos

27.0711 LEYLA brazo rigido

27.0712 LEYLA cabeza porta-brazos para 1 - 5 brazos
flexibles

27.0713 LEYLA Mecanismo para fijar el brazo
sobre la mesa de operaciones

27.1031 ESPATULA 200 / 9 mm

27.1032 ESPATULA 200 / 12 mm

composto da:

27.0705 LEYLA braccio flessibile

27.0709 LEYLA Sostegno per spatole piatte

27.0711 LEYLA Braccio di fissaggio

27.0712 LEYLA Pezzo per fissare 1 - 5 bracci

27.0713 LEYLA Meccanismo per fissare il braccio
al tavolo operatorio

27.1031 SPATOLA 200 / 9 mm

27.1032 SPATOLA 200 / 12 mm

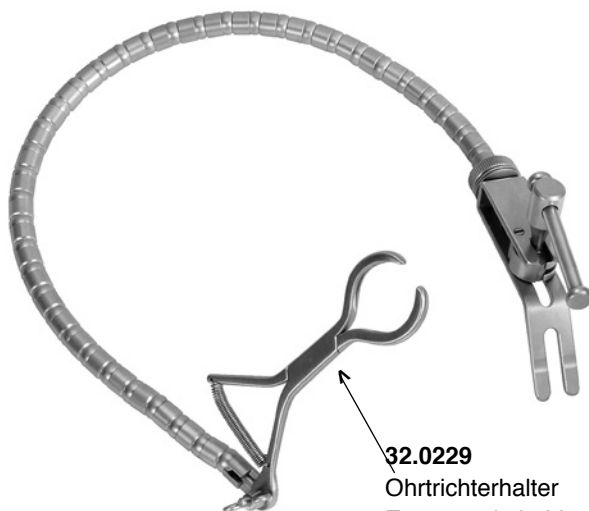

32.0220

LEYLA Ohrspekulahalter komplett
LEYLA Ear specula holder complete
LEYLA tendeur de spéculums auriculaires
LEYLA porta-especulos auriculares compl.
LEYLA Portaspecoli auricolari completo

32.0229

Ohrtrichterhalter
Ear specula holder
Tendeur de spéculums
Porta-especulos auriculares
Pinza portaspecoli auricolari

bestehend aus:

27.0705 LEYLA Spannarm allein
27.0708 LEYLA Fixiervorrichtung für Rohrteile
32.0229 LEYLA Ohrstrichterhalter

consisting of:

27.0705 LEYLA flexible arm only
27.0708 LEYLA Fixation base for mounting to bars
32.0229 LEYLA Ear specula holder

comprenant:

27.0705 LEYLA bras tendeur flexible
27.0708 LEYLA etau cranien simple pour attacher à potence etc.
32.0229 LEYLA Tendeur de spéculums

compuesto de:

27.0705 LEYLA brazo flexible
27.0708 LEYLA dispositivo a fijación al brazo rígido
32.0229 LEYLA Porta-especulos auriculares

composto da:

27.0705 LEYLA braccio flessibile
27.0708 LEYLA Fissatore per 1 braccio al braccio
32.0229 LEYLA Pinza portaspecoli

27.0705 LEYLA Spannarm
flexible arm
Bras tendeur flexible
Brazo flexible
Braccio flessibile



27.0706 LEYLA Fixiervorrichtung für 1 Spannarm
fixation base for 1 flexible arm
étau crânien pour 1 bras flexible
dispositivo a fijación 1 brazo flexible
Fissatore per 1 braccio al cranio



27.0707 LEYLA Fixiervorrichtung für 2 Spannarme
fixation base for 2 flexible arms
étau crânien pour 2 bras flexibles
dispositivo a fijación 2 brazos flexibles
Fissatore per 2 bracci al cranio



27.0708 Fixiervorrichtung für 1 Spannarm 27.0705 zum Befestigen an Rohrteilen
Fixation base for 1 flexible arm 27.0705 for attaching to round bars
Pièce de fixation pour 1 bras 27.0705 aux tiges rondes
Fijador para 1 brazo 27.0705 para fijar al tubos
Fissatore per 1 braccio 27.0705 per fissare ai bracci rotondi



27.0709 LEYLA Flachspatelhalter
support for flat spatulas
porte-spatules plates
soporte para espátulas llanas
Sostegno per spatole piatte



27.0710 LEYLA Rundspatelhalter
support for round spatulas
porte-spatules pour spatules ronds
porta-espátulas para espátulas rondos
Sostegno per spatole con asta rotonda



- 27.0711** LEYLA Haltearm starr
Holding Rod rigid
Potence, rigide
Brazo rigido
Braccio rigido



- 27.0712** Kupplungskopf zur Aufnahme von 1 - 5 Spannarmen 27.0705
Coupling head for 1-5 flexible arms 27.0705
tête porte-bras pour 1 - 5 bras tendeur 27.0705
cabeza porta-brazos para 1-5 brazos flexibles 27.0705
Pezzo da combinare 1 - 5 bracci 27.0705



- 27.0713** Kugelgelenkkolben zum Befestigen des Haltearms 27.0711 am OP-Tisch
Ball-and -socket joint for attaching Rod 27.0711 to operating table
Pièce de fixation pour attacher le bras 27.0711 à la table d'opération
Mecanismo para fijar el brazo 27.0711 sobre la mesa de operaciones
Meccanismo per fissare il braccio 27.0711 al tavolo operatorio



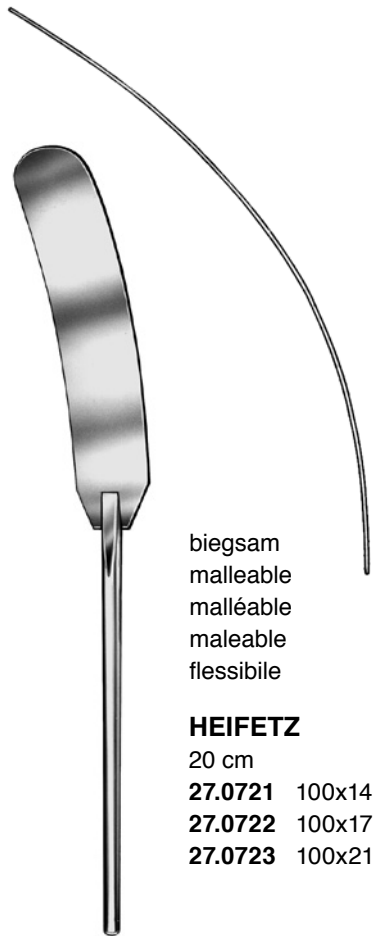

biegsam
 malleable
 malléable
 maleable
 flessibile

HEIFETZ

20 cm

- 27.0721** 100x14 mm
- 27.0722** 100x17 mm
- 27.0723** 100x21 mm

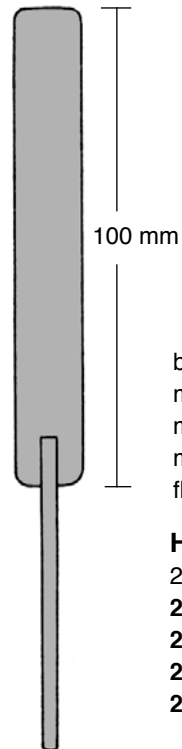

100 mm

biegsam
 malleable
 malléable
 maleable
 flessibile

HEIFETZ

20 cm

- 27.1026** 8 mm
- 27.1027** 11 mm
- 27.1028** 14 mm
- 27.1029** 17 mm



“AACHEN”

20 cm

- 27.1041** 7/ 8 mm
- 27.1042** 10/11 mm
- 27.1043** 13/14 mm
- 27.1044** 16/17 mm
- 27.1045** 19/20 mm
- 27.1046** 22/25 mm



DAVIS

18 cm

- 27.1050** 6,0 mm
- 27.1051** 9,5 mm
- 27.1052** 13,5 mm
- 27.1053** 16,0 mm
- 27.1054** 19,0 mm
- 27.1055** 25,0 mm
- 27.1056** 32,0 mm
- 27.1057** 38,0 mm



SCOVILLE

20 cm

- 27.1060** 10/13 mm
- 27.1061** 16/19 mm



27.1031 200 x 9 mm
27.1032 200 x 12 mm
27.1033 250 x 12 mm

biegsam
 malleable
 malléable
 maleable
 flessibile



27.1034 „MEMORY“ 200 x 9 mm
27.1035 „MEMORY“ 200 x 12 mm
27.1036 „MEMORY“ 200 x 14 mm
27.1037 „MEMORY“ 200 x 18 mm
27.1038 „MEMORY“ 200 x 20 mm
27.1039 „MEMORY“ 200 x 25 mm

biegsame „MEMORY“-Legierung
 malleable „MEMORY“ alloy
 alliage flexible „MEMORY“
 aleación flexible „MEMORY“
 lega flessibile „MEMORY“

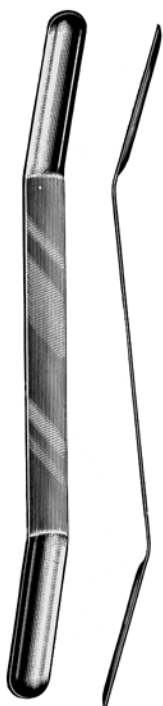

OLIVECRONA

konkav / concave
 concave / cóncavas
 concave

18 cm

27.1000 7 x 9 mm
27.1001 11 x 13 mm
27.1002 15 x 18 mm
27.1003 18 x 22 mm

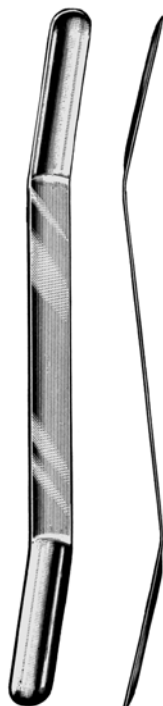

OLIVECRONA

konvex / convex
 convexe / convexas
 convesse

18 cm

27.1005 7 x 9 mm
27.1006 11 x 13 mm
27.1007 15 x 18 mm
27.1008 18 x 22 mm



CUSHING

27.1010

17 cm 8 x 10 mm

27.1012

20 cm 13 x 15 mm



CLOWARD

27.1451

16 cm

Spreizweite	15 mm
opening	15 mm
écartement	15 mm
abertura	15 mm
apertura	15 mm

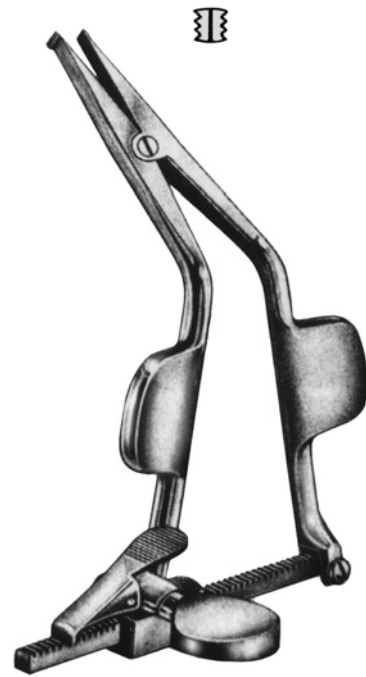

CLOWARD

27.1455

13 cm

Spreizweite	20 mm
opening	20 mm
écartement	20 mm
abertura	20 mm
apertura	20 mm

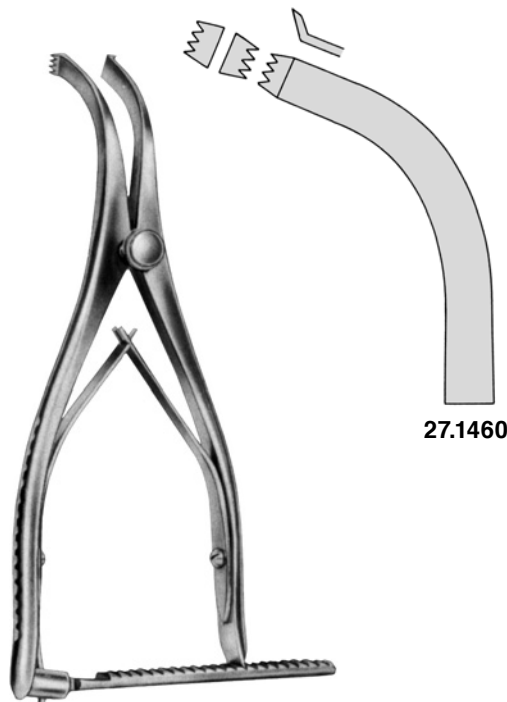

INGE-BABY

17 cm

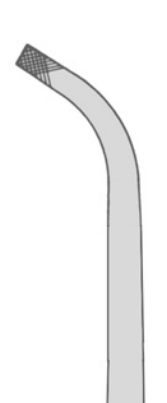

27.1461

WIRBELKÖRPERSPREIZER
LAMINA SPREADERS
ECARTEURS POUR CORPS VERTEBRAUX
SEPARADORES PARA CUERPOS VERTEBRALES
SEPARATORI PER VERTEBRE

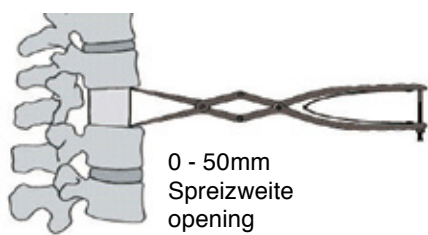

0 - 50mm
 Spreizweite
 opening
 ouverture
 apertura
 apertura

27.1470
 42,5cm
 THG Vertebraispreizer
 THG Vertebra Spreader
 THG Ecart.vertebral
 THG Separador vertebral
 THG Separatore p. vertebre



INGE
 27 cm

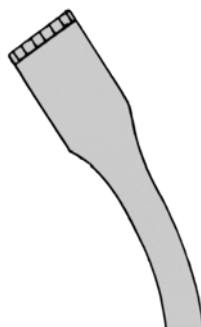

27.1465
 9 mm

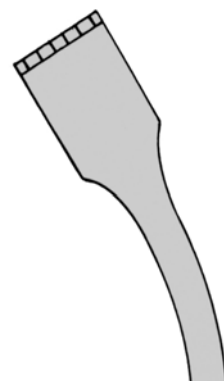

27.1466
 12 mm

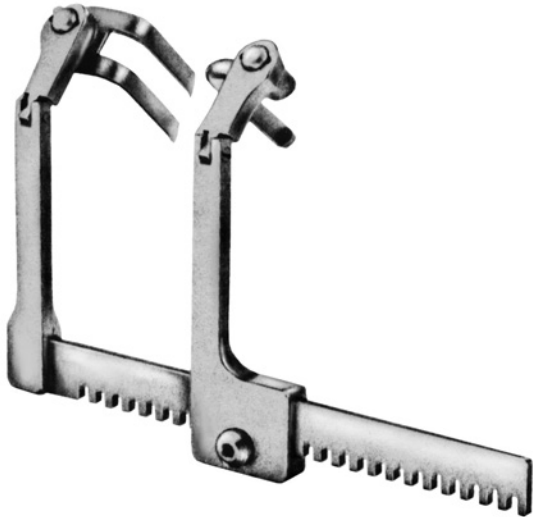

CASPAR

27.5050

Sperrer komplett mit 5 Valven 27.5062, 27.5072 - 27.5076 und Schlüssel 33.0119
 Retractor complete with 5 blades 27.5062, 27.5072 - 27.5076 and key 33.0119
 Ecarteur complet avec 5 valves 27.5062, 27.5072 - 27.5076 et clé 33.0119
 Separador completo con 5 valvas 27.5062, 27.5072 - 27.5076 y clavo 33.0119
 Divaricatore completo con 5 valve 27.5062, 27.5072 - 27.5076 e chiave 33.0119

27.5051

Sperrer allein mit Schlüssel 33.0119
 Retractor only with key 33.0119
 Ecarteur seul avec clé 33.0119
 Separador solamente con llave 33.0119
 Divaricatore solo con chiave 33.0119



27.5062 38 mm



27.5063 58 mm



33.0119

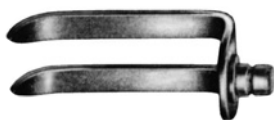

- 27.5071** 32 x 22 mm
- 27.5072** 37 x 22 mm
- 27.5073** 43 x 22 mm
- 27.5074** 47 x 22 mm
- 27.5075** 52 x 22 mm
- 27.5076** 57 x 22 mm
- 27.5077** 62 x 22 mm
- 27.5078** 67 x 22 mm

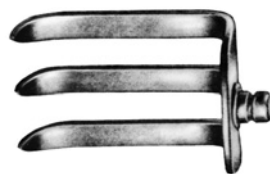

- 27.5081** 32 x 37 mm
- 27.5082** 37 x 37 mm
- 27.5083** 43 x 37 mm
- 27.5084** 47 x 37 mm
- 27.5085** 52 x 37 mm
- 27.5086** 57 x 37 mm
- 27.5087** 62 x 37 mm
- 27.5088** 67 x 37 mm

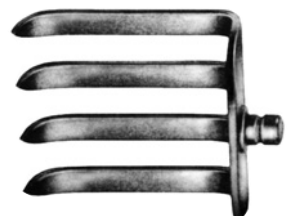

- 27.5091** 32 x 52 mm
- 27.5092** 37 x 52 mm
- 27.5093** 43 x 52 mm
- 27.5094** 47 x 52 mm
- 27.5095** 52 x 52 mm
- 27.5096** 57 x 52 mm
- 27.5097** 62 x 52 mm
- 27.5098** 67 x 52 mm

SPERRER FÜR DIE LUMBALE WIRBELSÄULE
RETRACTORS FOR LUMBAR VERTEBRAL COLUMN
ECARTEURS POUR CHIRURGIE LOMBAIRE
SEPARADORES PARA LA CIRUGIA LUMBAR VERTEBRAL
DIVARICATORI PER COLONNA LOMBO VERTEBRALE



27.5021	40 mm	
27.5022	45 mm	
27.5023	50 mm	
27.5024	55 mm	
27.5025	60 mm	
27.5026	65 mm	
27.5027	70 mm	

CASPAR

17 cm

27.5000

Sperrer komplett mit 7 Valven 27.5021 - 27.5027

Retractor complete with 7 blades 27.5021 - 27.5027

Ecarteur complet avec 7 valves 27.5021 - 27.5027

Separador completo con 7 valvas 27.5021 - 27.5027

Divaricatore completo con 7 valve 27.5021 - 27.5027

27.5001

Sperrer allein / retractor only

ecarteur seul / separador solamente /

Divaricatore solo



CASPAR
27.5100

Sperrer komplett mit 5 Valven 27.5183 - 27.5187
 Retractor complete with 5 blades 27.5183 - 27.5187
 Ecarteur complet avec 5 valves 27.5183 - 27.5187
 Separador completo con 5 valvas 27.5183 - 27.5187
 Divaricatore completo con 5 valve 27.5183 - 27.5187

27.5101

Sperrer allein / retractor only
 ecarteur seul / separador solamente / divaricatore solo

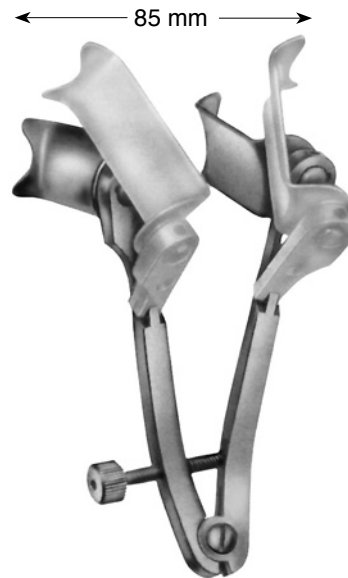

CASPAR
27.5110

Sperrer komplett mit 5 Valven 27.5183 - 27.5187
 Retractor complete with 5 blades 27.5183 - 27.5187
 Ecarteur complet avec 5 valves 27.5183 - 27.5187
 Separador completo con 5 valvas 27.5183 - 27.5187
 Divaricatore completo con 5 valve 27.5183 - 27.5187

27.5111

Sperrer allein / retractor only
 ecarteur seul / separador solamente / divaricatore solo



CASPAR
27.5120

Cervicalsperrer mit je 1 Valve
 27.5132 - 27.5136; 27.5152 - 27.5156

Cervical Retractor complete with 1 ea. Valve
 27.5132 - 27.5136; 27.5152 - 27.5156

Ecarteur cervical complet avec 1 chacun
 27.5132 - 27.5136; 27.5152 - 27.5156

Separador cervical completo con 1 c/u
 27.5132 - 27.5136; 27.5152 - 27.5156

Divaricatore completo con 1 ciascuno
 27.5132 - 27.5136; 27.5152 - 27.5156

27.5121

Sperrer allein / retractor only
 ecarteur seul / separador solamente / Divaricatore solo

**SPERRER FÜR DIE CERVICALE WIRBELSÄULE
RETRACTORS FOR CERVICAL VERTEBRAL COLUMN
ECARTEURS POUR COLONNE CERVICALE
SEPARADORES PARA LA COLUMNA CERVICAL
DIVARICATORI PER COLONNA CERVICALE**

Valven für CASPAR Sperrer
Blades for CASPAR retractors
Valves pour écarteurs CASPAR
Valvas para separadores CASPAR
Valve per divaricatore CASPAR



CASPAR TITANIUM

- 27.5122 40 x 25 mm
- 27.5123 45 x 25 mm
- 27.5124 50 x 25 mm
- 27.5125 55 x 25 mm
- 27.5126 60 x 25 mm

MEDIAL



CASPAR

- 27.5152 40 x 23 mm
- 27.5153 45 x 23 mm
- 27.5154 50 x 23 mm
- 27.5155 55 x 23 mm
- 27.5156 60 x 23 mm

LATERAL



CASPAR

- 27.5132 40 x 23 mm
- 27.5133 45 x 23 mm
- 27.5134 50 x 23 mm
- 27.5135 55 x 23 mm
- 27.5136 60 x 23 mm

MEDIAL

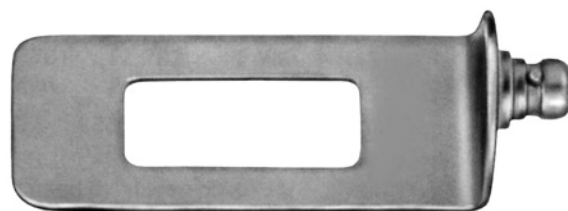

CASPAR

- 27.5164 50 x 25 mm
- 27.5166 60 x 25 mm



CASPAR TITANIUM

- 27.5142 40 x 25 mm
- 27.5143 45 x 25 mm
- 27.5144 50 x 25 mm
- 27.5145 55 x 25 mm
- 27.5146 60 x 25 mm

LATERAL



CASPAR

- 27.5183 45 x 23 mm
- 27.5184 50 x 23 mm
- 27.5185 55 x 23 mm
- 27.5186 60 x 23 mm
- 27.5187 65 x 23 mm



CASPAR

27.5199

Pinzette zum Blattwechsel
Forceps for changing valves
Pince pour changer les valves
Pinza para cambiari valvas
Pinza per cambiare valve



- 27.5400 40 mm
- 27.5401 45 mm
- 27.5402 50 mm
- 27.5403 55 mm
- 27.5404 60 mm
- 27.5405 65 mm
- 27.5406 75 mm
- 27.5407 85 mm



modifiziertes Model
 improved model
 modèle modifié
 modelo modificado
 modello modific.

CASPAR
 27.5400 - 27.5407

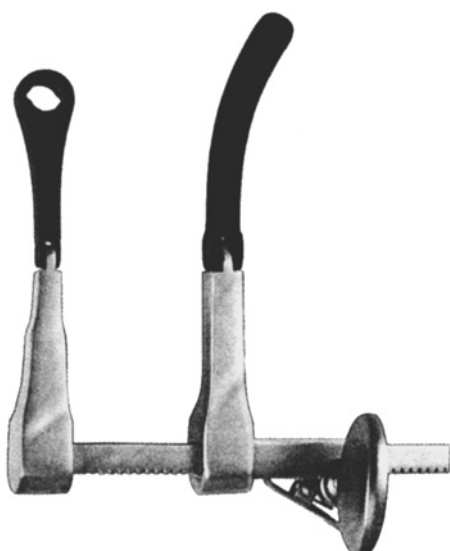

CASPAR

27.5440

Gegensperrer komplett bestehend aus:

- 27.5441 Gegensperrer
- 27.5430 - 27.5435 6 Valven 35, 40, 45, 50, 55, 60 mm

Counter-Retractor complete, consisting of:

- 27.5441 Counter Retractor
- 27.5430 - 27.5435 6 Blades 35, 40, 45, 50, 55, 60 mm

Contre-Ecarteur complet, comprenant:

- 27.5441 Contre-Écarteur
- 27.5430 - 27.5435 6 valves 35, 40, 45, 50, 55, 60 mm

Contra-Separador completo, compuesto de:

- 27.5441 Contra-separador
- 27.5430 - 27.5435 6 valvas 35, 40, 45, 50, 55, 60 mm

Contra-Divaricatore completo, composta da:

- 27.5441 Contra-divaricatore
- 27.5430 - 27.5435 6 valve 35, 40, 45, 50, 55, 60 mm

CASPAR

27.5441

- Gegensperrer alleine / Counter-Retractor only
- Contre-Ecarteur seul / Contra-Separador suelto
- Contra-Divaricatore solo

WUNDSPREIZER ZUR MIKRODISKEKTOMIE
RETRACTORS FOR MICRO-LUMBAR DISCECTOMY
ECARTEURS POUR LA MICRO-DISQUECTOMIE LOMBAIRE
SEPARADORES PARA LA MICRODISCECTOMIA LOMBAR
DIVARICATORI PER LA MICRO DISCECTOMIA LOMBARE



CASPAR



27.5030 45 mm



27.5033 60 mm



27.5031 50 mm



27.5034 65 mm



27.5032 55 mm



CASPAR

27.5420

Sperrer komplett mit 6 Valven 27.5430 - 27.5435
 Retractor complete with 6 blades 27.5430 - 27.5435
 Ecarteur complet avec 6 valves 27.5430 - 27.5435
 Separador completo con 6 valvas 27.5430 - 27.5435
 Divaricatore completo con 6 valve 27.5430 - 27.5435

27.5421

Sperrer allein / retractor only
 ecarteur seul / separador solamente / divaricatore solo

27.5430 35 mm



27.5431 40 mm



27.5432 45 mm



27.5433 50 mm



27.5434 55 mm



27.5435 60 mm



27.5436 65 mm



27.5437 75 mm



27.5438 85 mm





CASPAR

27.5500

Wirbelkörperdistraktor für Operationen an unterer und mittlerer Halswirbelsäule von links, bestehend aus:

- 27.5501 Distraktor
- 27.5509 Bohrlehre links
- 27.5520 Bohrer
- 27.5536 Distractionsschrauben 16 mm (2 St.)
- 27.5550 Schraubendreher

Vertebral body distractor for surgical procedures of the cervical spine, from the left, consisting of:

- 27.5501 Distractor
- 27.5509 Drillguide, left
- 27.5520 Twist Drill
- 27.5536 Distraction screws 16 mm (2 pcs.)
- 27.5550 Screwdriver

Distracteur des corps vertébraux pour la chirurgie de la colonne cervicale, accès du côté gauche, comprenant:

- 27.5501 Distracteur
- 27.5509 Guide-forets, gauche
- 27.5520 Foret
- 27.5536 Vis à distraction 16 mm (2 pcs.)
- 27.5550 Tourne-vis

Distractor de los cuerpos vertebrales para la cirugía de la columna cervical, acceso del lado izquierdo, compuesto de:

- 27.5501 Distractor
- 27.5509 Guia para brocas, a la izquierda
- 27.5520 Perforador
- 27.5536 Tornillos para distracción 16 mm (2 pzas.)
- 27.5550 Destornillador

Distrattore die corpi vertebrali per la chirurgia della colonna cervicale, accesso del lato sinistro, composta da:

- 27.5501 Distrattore
- 27.5509 Guida di perforatore, sinistra
- 27.5520 Perforatore
- 27.5536 Viti di distrazione 16 mm (2 pezzi)
- 27.5550 Cacciavite

27.5501

Distraktor alleine / Distractor only / Distracteur seul / Distractor suelto / Distrattore solo



27.5509

Bohrlehre, links für 27.5500
Drill Guide, left for 27.5500
Guide-forets, gauche pour 27.5500
Guia para brocas, a la izquierda para 27.5500
Guida di perforatore, sinistra - per 27.5500



27.5519

Bohrlehre, rechts für 27.5510
Drill Guide, right for 27.5510
Guide-forets, droite pour 27.5510
Guia para brocas, a la derecha para 27.5510
Guida di perforatore, destra - per 27.5510



CASPAR

27.5510

Wirbelkörperdistraktor für Operationen an unterer und mittlerer Halswirbelsäule von rechts, bestehend aus:

27.5511 Distraktor
28.5519 Bohrlehre rechts
27.5520 Bohrer
27.5536 Distractionsschrauben 16 mm (2 St.)
27.5500 Schraubendreher

Vertebral body distractor for surgical procedures of the cervical spine, from the right, consisting of:

27.5511 Distractor
28.5519 Drillguide, right
27.5520 Twist Drill
27.5536 Distraction screws 16 mm (2 pcs.)
27.5500 Screwdriver

Distracteur des corps vertébraux pour la chirurgie de la colonne cervicale, accès du côté droite, comprenant:

27.5511 Distracteur
28.5519 Guide-forets, droite
27.5520 Foret
27.5536 Vis à distraction 16 mm (2 pcs.)
27.5500 Tourne-vis

Distractor de los cuerpos vertebrales para la cirugía de la columna cervical, acceso del lado derecho, compuesto de:

27.5511 Distractor
28.5519 Guia para brocas, a la derecha
27.5520 Perforador
27.5536 Tornillos para distracción 16 mm (2 pzas.)
27.5500 Destornillador

Distrattore die corpi vertebrali per la chirurgia della colonna cervicale, accesso del lato destro, composta da:

27.5511 Distrattore
28.5519 Guida di perforatore, destra
27.5520 Perforatore
27.5536 Viti di distrazione 16 mm (2 pezzi)
27.5500 Cacciavite

27.5511

Distraktor alleine / Distractor only / Distracteur seul /
Distractor suelto / Distrattore solo

WUNDSPREIZER ZUR MIKRODISSEKTOMIE
 RETRACTORS FOR MICRO-LUMBAR DISCECTOMY
 ECARTEURS POUR LA MICRO-DISQUECTOMIE LOMBAIRE
 SEPARADORES PARA LA MICRODISSECTOMIA LOMBAR
 DIVARICATORI PER LA MICRO DISSECTOMIA LOMBAR



Bohrer
 Drill
 Mèche
 Broca
 Perforatore

CASPAR
 27.5520
 14,5 cm / 1,7 mm

Distraktionsschraube
 Distraction screw
 Vis à distraction
 Tornillo para distracción
 Viti di distrazione



CASPAR
 27.5532 12 mm
 27.5534 14 mm
 27.5536 16 mm
 27.5538 18 mm



Schraubenzieher
 Screwdriver
 Tourne-vis
 Destornillador
 Giravite

CASPAR
 27.5550 20 cm

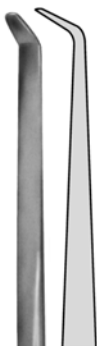

27.5561
 # 1



27.5562
 # 2

Längsband-Dissektoren
 Vertebral body dissector
 Dissecteurs vertébraux
 Disecadores para cuerpos vertebrales
 Dissettori per corpo vertebrale

CASPAR
 20,5 cm

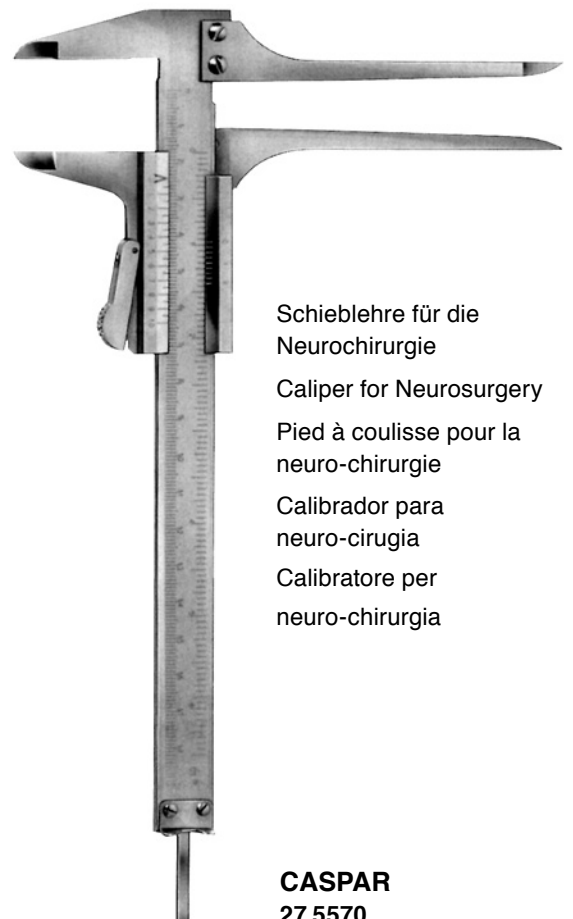

Schieblehre für die
 Neurochirurgie
 Caliper for Neurosurgery
 Pied à coulisse pour la
 neuro-chirurgie
 Calibrador para
 neuro-cirurgia
 Calibratore per
 neuro-chirurgia

CASPAR
 27.5570

WUNDSPREIZER ZUR MIKRODISKEKTOMIE
RETRACTORS FOR MICRO-LUMBAR DISCECTOMY
ECARTEURS POUR LA MICRO-DISQUECTOMIE LOMBAIRE
SEPARADORES PARA LA MICRODISCECTOMIA LOMBAR
DIVARICATORI PER LA MICRO DISCECTOMIA LOMBAR



Halte- und Einschlaginstrument
 Bone graft holder and impactor
 Tendeur et impacteur
 Impactor
 Impattore

CASPAR
27.5580
 21 cm



27.5593
 3 mm



27.5595
 5 mm



27.5598
 8 mm

Stößel
 Tampers
 hémostats
 hemostaticas
 Pestello

CASPAR
 20 cm

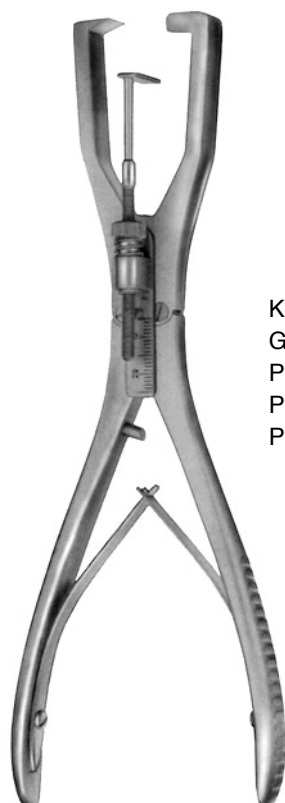

Knochenmarkschneider
 Graft cutter
 Pince coupante moelle
 Pinza para cortar médula
 Pinza cortante midollo osseo

CASPAR
27.5600
 22 cm

Auswerfer
Ejector
Ejecteur
Eyector
Estrattore

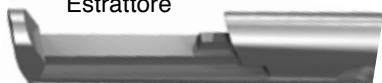

dünne Fußplatte/thin footplate/
Footplate fin/Footplate fino/
Bocca sottile



CLICK-KERRISON



matt/satin/mat
mate/opaco

27.3000.00



schwarz/black,
noir/negro/nero

27.3000.00B

Griffe / Handles / Manches /
Mangos / Manici

Schaft/Shaft/Tige/
Vestago/Asta



27.3011.10	27.3011.10B	18 cm 1 mm 40°
27.3011.20	27.3011.20B	18 cm 2 mm 40°
27.3011.30	27.3011.30B	18 cm 3 mm 40°
27.3011.40	27.3011.40B	18 cm 4 mm 40°
27.3011.50	27.3011.50B	18 cm 5 mm 40°
27.3011.60	27.3011.60B	18 cm 6 mm 40°
27.3021.10	27.3021.10B	20 cm 1 mm 40°
27.3021.20	27.3021.20B	20 cm 2 mm 40°
27.3021.30	27.3021.30B	20 cm 3 mm 40°
27.3021.40	27.3021.40B	20 cm 4 mm 40°
27.3021.50	27.3021.50B	20 cm 5 mm 40°
27.3021.60	27.3021.60B	20 cm 6 mm 40°
27.3031.10	27.3031.10B	23 cm 1 mm 40°
27.3031.20	27.3031.20B	23 cm 2 mm 40°
27.3031.30	27.3031.30B	23 cm 3 mm 40°
27.3031.40	27.3031.40B	23 cm 4 mm 40°
27.3031.50	27.3031.50B	23 cm 5 mm 40°
27.3031.60	27.3031.60B	23 cm 6 mm 40°
27.3041.10	27.3041.10B	25 cm 1 mm 40°
27.3041.20	27.3041.20B	25 cm 2 mm 40°
27.3041.30	27.3041.30B	25 cm 3 mm 40°
27.3041.40	27.3041.40B	25 cm 4 mm 40°
27.3041.50	27.3041.50B	25 cm 5 mm 40°
27.3041.60	27.3041.60B	25 cm 6 mm 40°
27.3051.10	27.3051.10B	28 cm 1 mm 40°
27.3051.20	27.3051.20B	28 cm 2 mm 40°
27.3051.30	27.3051.30B	28 cm 3 mm 40°
27.3051.40	27.3051.40B	28 cm 4 mm 40°
27.3051.50	27.3051.50B	28 cm 5 mm 40°
27.3051.60	27.3051.60B	28 cm 6 mm 40°
27.3061.10	27.3061.10B	30 cm 1 mm 40°
27.3061.20	27.3061.20B	30 cm 2 mm 40°
27.3061.30	27.3061.30B	30 cm 3 mm 40°
27.3061.40	27.3061.40B	30 cm 4 mm 40°
27.3061.50	27.3061.50B	30 cm 5 mm 40°
27.3061.60	27.3061.60B	30 cm 6 mm 40°



Position für die Montage/Demontage
Assembly/Dissassembly position
Position de montage/démontage
Posición para montaje/desmontaje
Posizione per montaggio/smontaggio

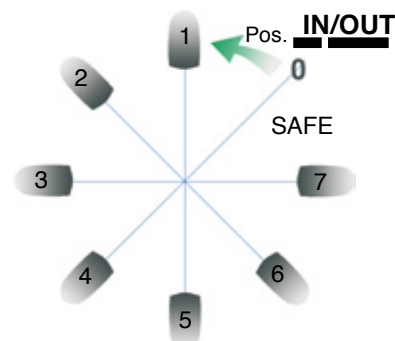

Schaft, jeweils um 45°, in
7 Arbeitspositionen verstellbar

Shaft adjustable in 7 positions in steps of 45°

Tige, réglable in 7 positions, par étapes de 45°

Vestago, ajustable en 7 posiciones por 45°

Asta regolabile in 7 posizioni intorno a 45°

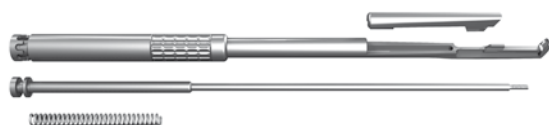

Schaft für die Aufbereitung komplett zerlegbar
Shaft to be dismantled completely for servicing
Tige séparable complètement pour nettoyage
Vestago desmontable completamente para limpieza
Asta completamente smontabile per pulizia

LAMINEKTOMIE-STANZEN
LAMINECTOMY PUNCHES
PINCES EMPORTE-PIECES A LAMINECTOMIE
PINZAS CORTANTES PARA LAMINECTOMIA
PINZE PER LAMINECTOMIA

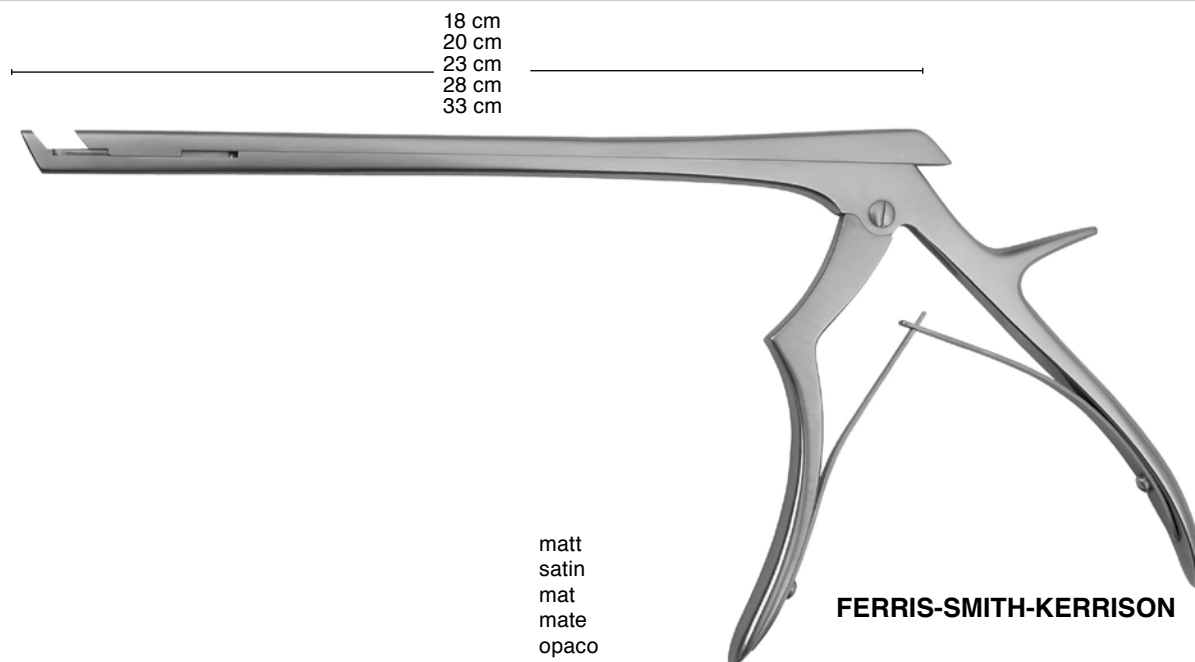

matt
satin
mat
mate
opaco



Auswerfer
Ejector
Ejecteur
Ejector
Estrattore

Bissbreite Width of bite Largeur des mors Anchura de la boca Larghezza del morso	Schaftlänge Length of shaft Longeur de la tige Longitud del vástago Lunghezza dell'asta	90°	40°	90°	40°	Auswerfer Ejector Ejecteur Ejector Estrattore
1,0 mm	18 cm	27.3210.10	27.3211.10	27.3212.10	27.3213.10	-
1,5 mm	18 cm		27.3211.15			-
2,0 mm	18 cm	27.3210.20	27.3211.20	27.3212.20	27.3213.20	+
2,5 mm	18 cm		27.3211.25			+
3,0 mm	18 cm	27.3210.30	27.3211.30	27.3212.30	27.3213.30	+
4,0 mm	18 cm	27.3210.40	27.3211.40	27.3212.40	27.3213.40	+
5,0 mm	18 cm	27.3210.50	27.3211.50	27.3212.50	27.3213.50	+
6,0 mm	18 cm	27.3210.60	27.3211.60	27.3212.60	27.3213.60	+
1,0 mm	20 cm	27.3220.10	27.3221.10	27.3222.10	27.3223.10	-
2,0 mm	20 cm	27.3220.20	27.3221.20	27.3222.20	27.3223.20	+
2,5 mm	20 cm		27.3221.25			+
3,0 mm	20 cm	27.3220.30	27.3221.30	27.3222.30	27.3223.30	+
4,0 mm	20 cm	27.3220.40	27.3221.40	27.3222.40	27.3223.40	+
5,0 mm	20 cm	27.3220.50	27.3221.50	27.3222.50	27.3223.50	+
6,0 mm	20 cm	27.3220.60	27.3221.60	27.3222.60	27.3223.60	+
1,0 mm	23 cm	27.3230.10	27.3231.10	27.3232.10	27.3233.10	-
2,0 mm	23 cm	27.3230.20	27.3231.20	27.3232.20	27.3233.20	+
3,0 mm	23 cm	27.3230.30	27.3231.30	27.3232.30	27.3233.30	+
4,0 mm	23 cm	27.3230.40	27.3231.40	27.3232.40	27.3233.40	+
5,0 mm	23 cm	27.3230.50	27.3231.50	27.3232.50	27.3233.50	+
6,0 mm	23 cm	27.3230.60	27.3231.60	27.3232.60	27.3233.60	+
1,0 mm	28 cm	27.3250.10	27.3251.10	27.3252.10		-
2,0 mm	28 cm	27.3250.20	27.3251.20	27.3252.20		+
3,0 mm	28 cm	27.3250.30	27.3251.30	27.3252.30		+
4,0 mm	28 cm	27.3250.40	27.3251.40	27.3252.40		+
5,0 mm	28 cm	27.3250.50	27.3251.50	27.3252.50		+
6,0 mm	28 cm	27.3250.60	27.3251.60	27.3252.60		+
1,0 mm	33 cm	27.3270.10	27.3271.10	27.3272.10		-
2,0 mm	33 cm	27.3270.20	27.3271.20	27.3272.20		+
3,0 mm	33 cm	27.3270.30	27.3271.30	27.3272.30		+
4,0 mm	33 cm	27.3270.40	27.3271.40	27.3272.40		+
5,0 mm	33 cm	27.3270.50	27.3271.50	27.3272.50		+
6,0 mm	33 cm	27.3270.60	27.3271.60	27.3272.60		+

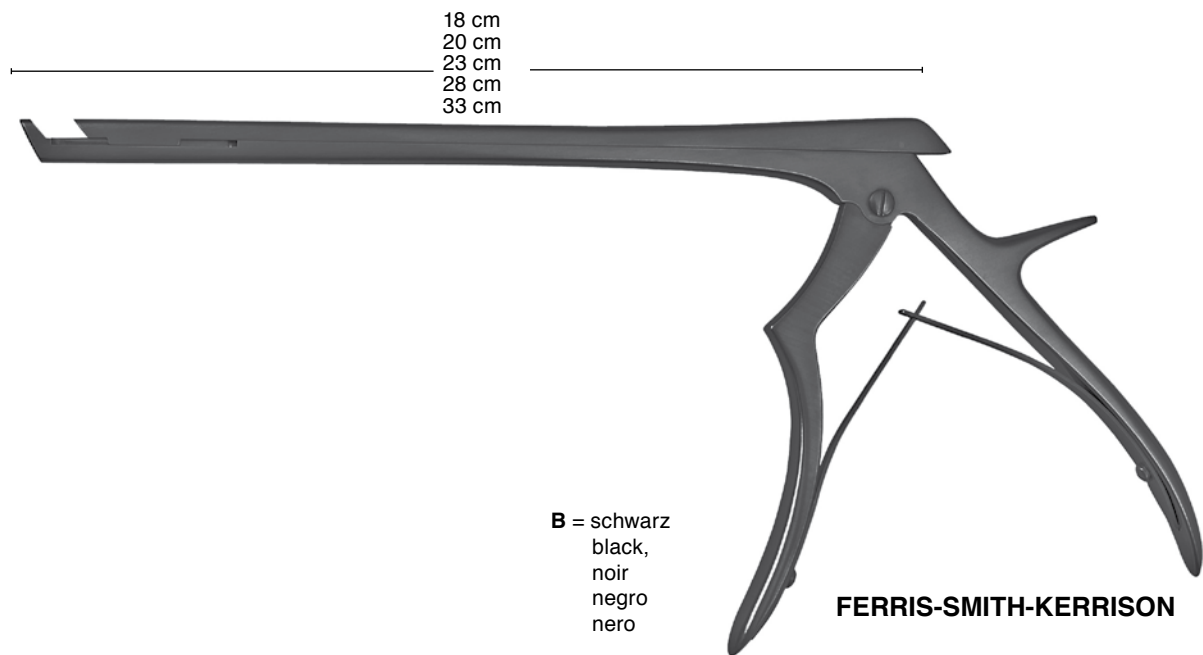



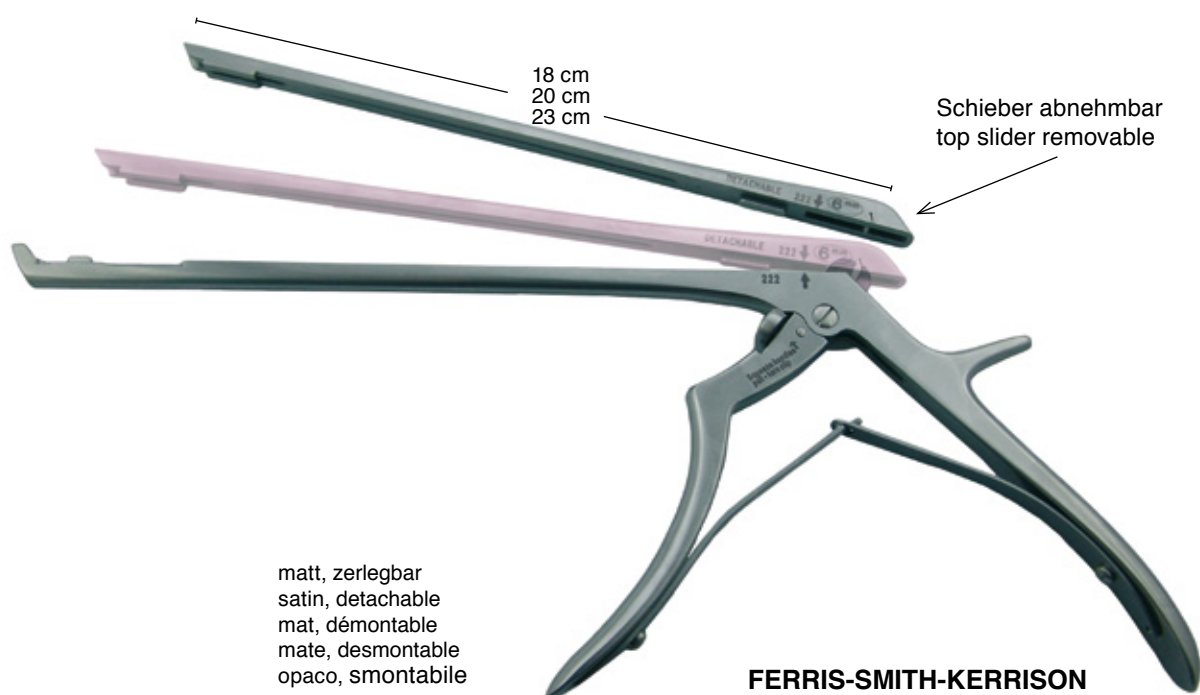

Bissbreite Width of bite Largeur des mors Anchura de la boca Larghezza del morso	Schaftlänge Length of shaft Longueur de la tige Longitud del vástago Lunghezza dell'asta	90°	40°	90°	40°	Auswerfer Ejector Ejecteur Eyetor Estrattore
1,0 mm	18 cm	27.3210.10B	27.3211.10B	27.3212.10B	27.3213.10B	-
1,5 mm	18 cm		27.3211.15B			-
2,0 mm	18 cm	27.3210.20B	27.3211.20B	27.3212.20B	27.3213.20B	+
2,5 mm	18 cm		27.3211.25B			+
3,0 mm	18 cm	27.3210.30B	27.3211.30B	27.3212.30B	27.3213.30B	+
4,0 mm	18 cm	27.3210.40B	27.3211.40B	27.3212.40B	27.3213.40B	+
5,0 mm	18 cm	27.3210.50B	27.3211.50B	27.3212.50B	27.3213.50B	+
6,0 mm	18 cm	27.3210.60B	27.3211.60B	27.3212.60B	27.3213.60B	+
1,0 mm	20 cm	27.3220.10B	27.3221.10B	27.3222.10B	27.3223.10B	-
2,0 mm	20 cm	27.3220.20B	27.3221.20B	27.3222.20B	27.3223.20B	+
2,5 mm	20 cm		27.3221.25B			+
3,0 mm	20 cm	27.3220.30B	27.3221.30B	27.3222.30B	27.3223.30B	+
4,0 mm	20 cm	27.3220.40B	27.3221.40B	27.3222.40B	27.3223.40B	+
5,0 mm	20 cm	27.3220.50B	27.3221.50B	27.3222.50B	27.3223.50B	+
6,0 mm	20 cm	27.3220.60B	27.3221.60B	27.3222.60B	27.3223.60B	+
1,0 mm	23 cm	27.3230.10B	27.3231.10B	27.3232.10B	27.3233.10B	-
2,0 mm	23 cm	27.3230.20B	27.3231.20B	27.3232.20B	27.3233.20B	+
3,0 mm	23 cm	27.3230.30B	27.3231.30B	27.3232.30B	27.3233.30B	+
4,0 mm	23 cm	27.3230.40B	27.3231.40B	27.3232.40B	27.3233.40B	+
5,0 mm	23 cm	27.3230.50B	27.3231.50B	27.3232.50B	27.3233.50B	+
6,0 mm	23 cm	27.3230.60B	27.3231.60B	27.3232.60B	27.3233.60B	+
1,0 mm	28 cm	27.3250.10B	27.3251.10B	27.3252.10B		-
2,0 mm	28 cm	27.3250.20B	27.3251.20B	27.3252.20B		+
3,0 mm	28 cm	27.3250.30B	27.3251.30B	27.3252.30B		+
4,0 mm	28 cm	27.3250.40B	27.3251.40B	27.3252.40B		+
5,0 mm	28 cm	27.3250.50B	27.3251.50B	27.3252.50B		+
6,0 mm	28 cm	27.3250.60B	27.3251.60B	27.3252.60B		+
1,0 mm	33 cm	27.3270.10B	27.3271.10B	27.3272.10B		-
2,0 mm	33 cm	27.3270.20B	27.3271.20B	27.3272.20B		+
3,0 mm	33 cm	27.3270.30B	27.3271.30B	27.3272.30B		+
4,0 mm	33 cm	27.3270.40B	27.3271.40B	27.3272.40B		+
5,0 mm	33 cm	27.3270.50B	27.3271.50B	27.3272.50B		+
6,0 mm	33 cm	27.3270.60B	27.3271.60B	27.3272.60B		+

LAMINEKTOMIE-STANZEN
LAMINECTOMY PUNCHES
PINCES EMPORTE-PIECES A LAMINECTOMIE
PINZAS CORTANTES PARA LAMINECTOMIA
PINZE PER LAMINECTOMIA





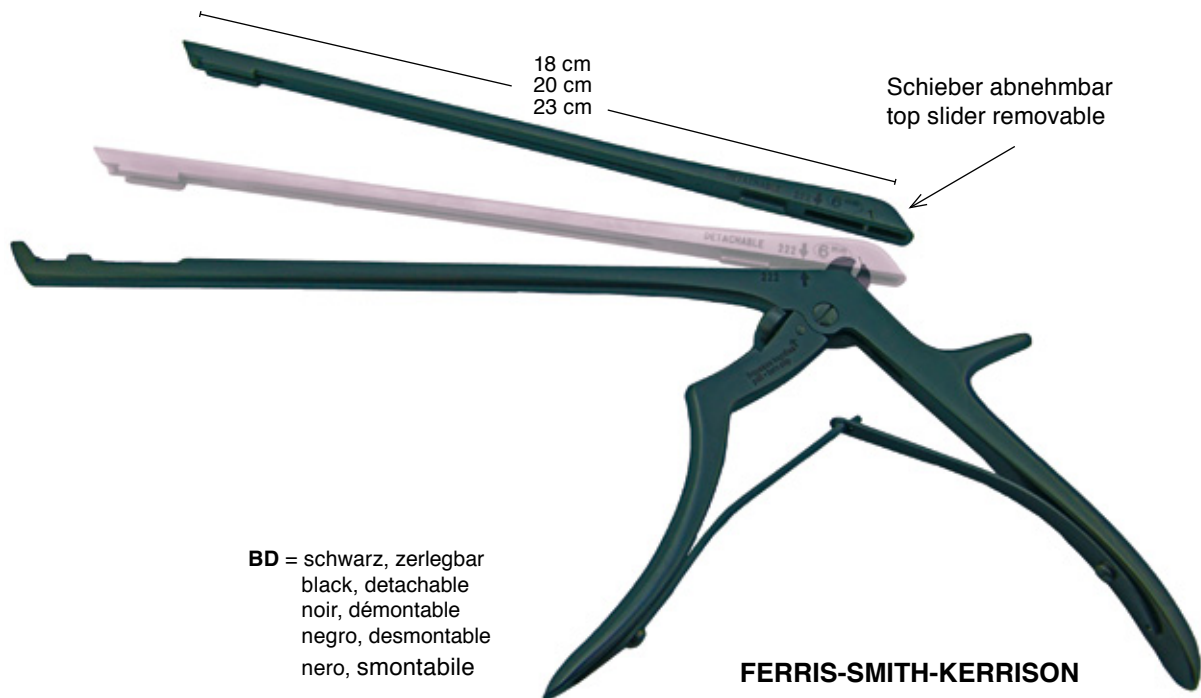

matt, zerlegbar
satin, detachable
mat, démontable
mate, desmontable
opaco, smontabile

FERRIS-SMITH-KERRISON

Bissbreite Width of bite Largeur des mors Anchura de la boca Larghezza del morso	Schaftlänge Length of shaft Longeur de la tige Longitud del vástago Lunghezza dell'asta	90°		40°		Auswerfer Ejector Ejecteur Ejector Estrattore
						
1,0 mm	18 cm	27.3210.10D	27.3211.10D	27.3212.10D	27.3213.10D	-
1,5 mm	18 cm		27.3211.15D			-
2,0 mm	18 cm	27.3210.20D	27.3211.20D	27.3212.20D	27.3213.20D	+
2,5 mm	18 cm		27.3211.25D			+
3,0 mm	18 cm	27.3210.30D	27.3211.30D	27.3212.30D	27.3213.30D	+
4,0 mm	18 cm	27.3210.40D	27.3211.40D	27.3212.40D	27.3213.40D	+
5,0 mm	18 cm	27.3210.50D	27.3211.50D	27.3212.50D	27.3213.50D	+
6,0 mm	18 cm	27.3210.60D	27.3211.60D	27.3212.60D	27.3213.60D	+
1,0 mm	20 cm	27.3220.10D	27.3221.10D	27.3222.10D	27.3223.10D	-
2,0 mm	20 cm	27.3220.20D	27.3221.20D	27.3222.20D	27.3223.20D	+
2,5 mm	20 cm		27.3221.25D			+
3,0 mm	20 cm	27.3220.30D	27.3221.30D	27.3222.30D	27.3223.30D	+
4,0 mm	20 cm	27.3220.40D	27.3221.40D	27.3222.40D	27.3223.40D	+
5,0 mm	20 cm	27.3220.50D	27.3221.50D	27.3222.50D	27.3223.50D	+
6,0 mm	20 cm	27.3220.60D	27.3221.60D	27.3222.60D	27.3223.60D	+
1,0 mm	23 cm	27.3230.10D	27.3231.10D	27.3232.10D	27.3233.10D	-
2,0 mm	23 cm	27.3230.20D	27.3231.20D	27.3232.20D	27.3233.20D	+
3,0 mm	23 cm	27.3230.30D	27.3231.30D	27.3232.30D	27.3233.30D	+
4,0 mm	23 cm	27.3230.40D	27.3231.40D	27.3232.40D	27.3233.40D	+
5,0 mm	23 cm	27.3230.50D	27.3231.50D	27.3232.50D	27.3233.50D	+
6,0 mm	23 cm	27.3230.60D	27.3231.60D	27.3232.60D	27.3233.60D	+



BD = schwarz, zerlegbar
 black, detachable
 noir, démontable
 negro, desmontable
 nero, smontabile

Bissbreite Width of bite Largeur des mors Anchura de la boca Larghezza del morso	Schaftlänge Length of shaft Longueur de la tige Longitud del vástago Lunghezza dell'asta	90°		40°		Auswerfer Ejector Ejecteur Ejector Estrattore
						
1,0 mm	18 cm	27.3210.10BD	27.3211.10BD	27.3212.10BD	27.3213.10BD	-
1,5 mm	18 cm		27.3211.15BD			-
2,0 mm	18 cm	27.3210.20BD	27.3211.20BD	27.3212.20BD	27.3213.20BD	+
2,5 mm	18 cm		27.3211.25BD			+
3,0 mm	18 cm	27.3210.30BD	27.3211.30BD	27.3212.30BD	27.3213.30BD	+
4,0 mm	18 cm	27.3210.40BD	27.3211.40BD	27.3212.40BD	27.3213.40BD	+
5,0 mm	18 cm	27.3210.50BD	27.3211.50BD	27.3212.50BD	27.3213.50BD	+
6,0 mm	18 cm	27.3210.60BD	27.3211.60BD	27.3212.60BD	27.3213.60BD	+
1,0 mm	20 cm	27.3220.10BD	27.3221.10BD	27.3222.10BD	27.3223.10BD	-
2,0 mm	20 cm	27.3220.20BD	27.3221.20BD	27.3222.20BD	27.3223.20BD	+
2,5 mm	20 cm		27.3221.25BD			+
3,0 mm	20 cm	27.3220.30BD	27.3221.30BD	27.3222.30BD	27.3223.30BD	+
4,0 mm	20 cm	27.3220.40BD	27.3221.40BD	27.3222.40BD	27.3223.40BD	+
5,0 mm	20 cm	27.3220.50BD	27.3221.50BD	27.3222.50BD	27.3223.50BD	+
6,0 mm	20 cm	27.3220.60BD	27.3221.60BD	27.3222.60BD	27.3223.60BD	+
1,0 mm	23 cm	27.3230.10BD	27.3231.10BD	27.3232.10BD	27.3233.10BD	-
2,0 mm	23 cm	27.3230.20BD	27.3231.20BD	27.3232.20BD	27.3233.20BD	+
3,0 mm	23 cm	27.3230.30BD	27.3231.30BD	27.3232.30BD	27.3233.30BD	+
4,0 mm	23 cm	27.3230.40BD	27.3231.40BD	27.3232.40BD	27.3233.40BD	+
5,0 mm	23 cm	27.3230.50BD	27.3231.50BD	27.3232.50BD	27.3233.50BD	+
6,0 mm	23 cm	27.3230.60BD	27.3231.60BD	27.3232.60BD	27.3233.60BD	+

LAMINEKTOMIE-STANZEN
LAMINECTOMY PUNCHES
PINCES EMPORTE-PIECES A LAMINECTOMIE
PINZAS CORTANTES PARA LAMINECTOMIA
PINZE PER LAMINECTOMIA

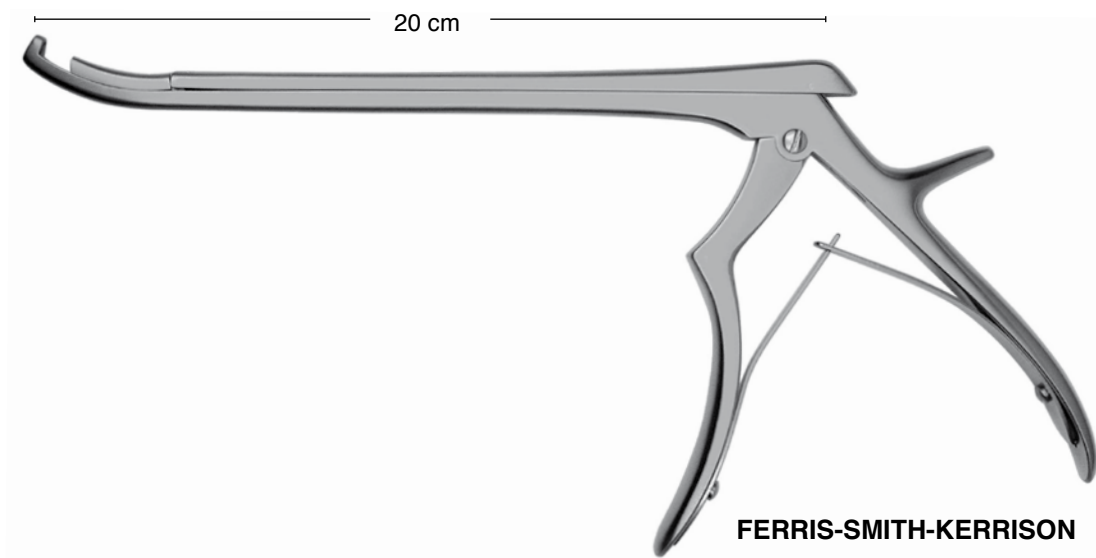

matt/satin/mat
mate/opaco

40°



schwarz/black,
noir/negro/nero

40°



Bissbreite	Schaftlänge
Width of bite	Length of shaft
Largeur des mors	Longueur de la tige
Anchura de la boca	Longitud del vástago
Larghezza del morso	Lunghezza dell'asta

2 mm	20 cm	27.3225.20	27.3225.20B
3 mm	20 cm	27.3225.30	27.3225.30B
4 mm	20 cm	27.3225.40	27.3225.40B
5 mm	20 cm	27.3225.50	27.3225.50B

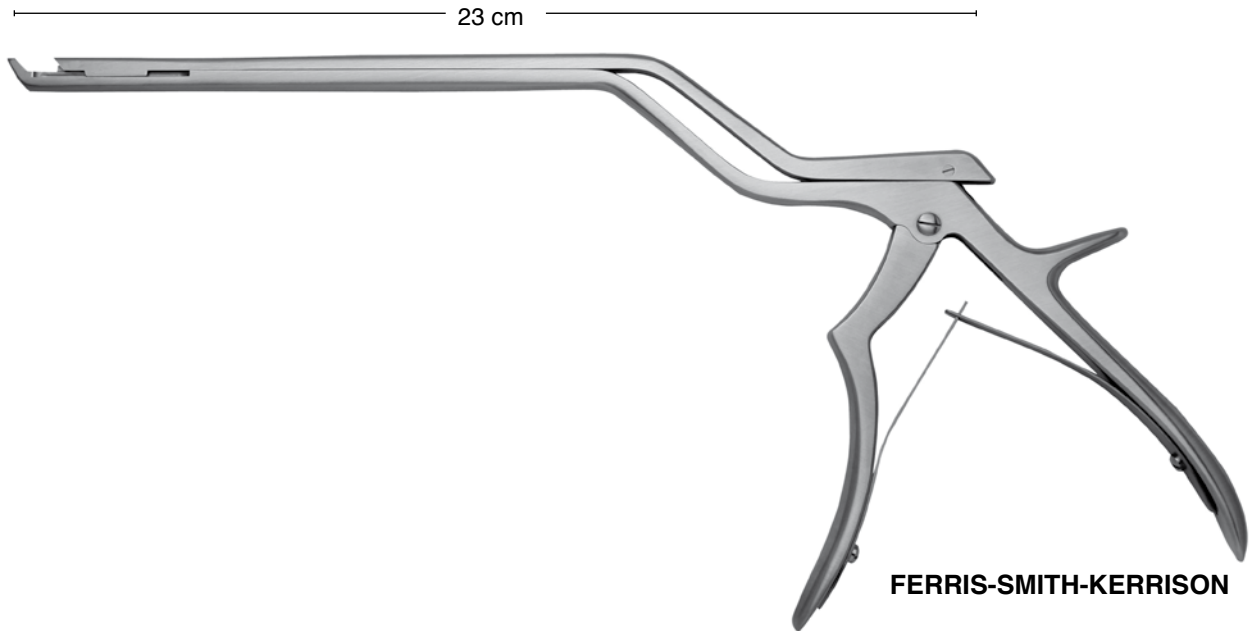

matt/satin/mat
 mate/opaco

40°



schwarz/black,
 noir/negro/nero

40°



Bissbreite	Schaftlänge
Width of bite	Length of shaft
Largeur des mors	Longeur de la tige
Anchura de la boca	Longitud del vástago
Larghezza del morso	Lunghezza dell'asta

2 mm	23 cm
3 mm	23 cm
4 mm	23 cm
5 mm	23 cm

27.3237,20
27.3237.30
27.3237.40
27.3237.50

27.3237,20B
27.3237.30B
27.3237.40B
27.3237.50B

LAMINEKTOMIE-STANZEN
LAMINECTOMY PUNCHES
PINCES EMPORTE-PIECES A LAMINECTOMIE
PINZAS CORTANTES PARA LAMINECTOMIA
PINZE PER LAMINECTOMIA

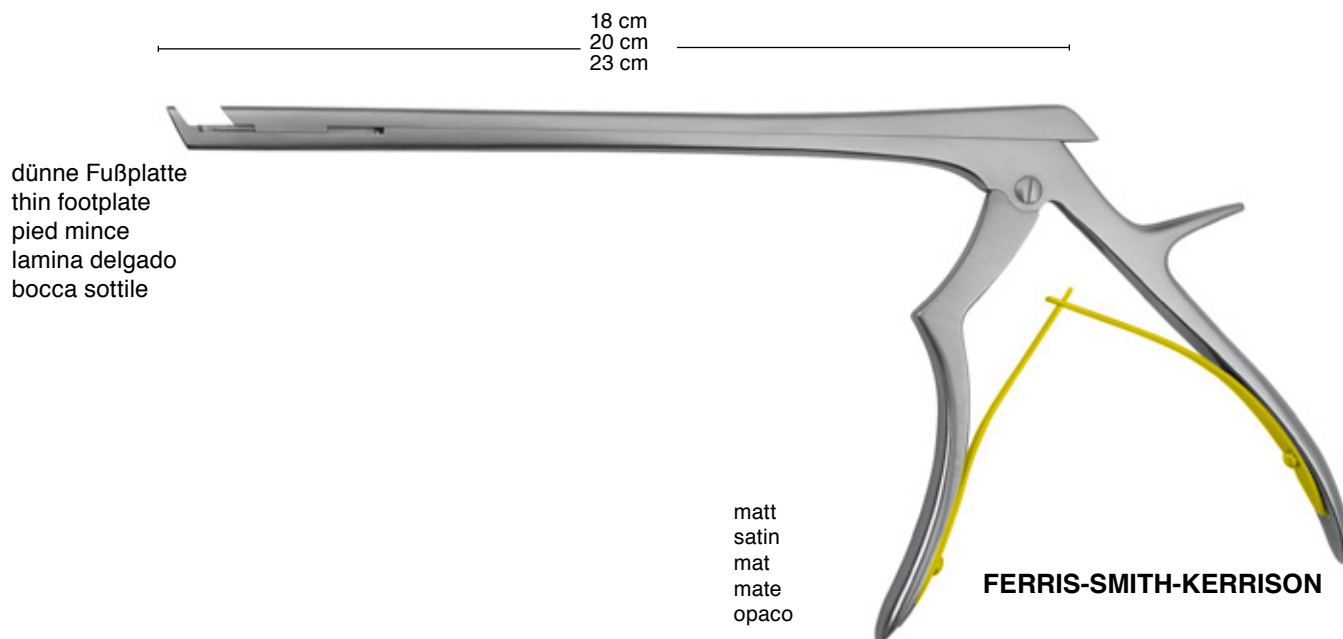

Bissbreite Width of bite Largeur des mors Anchura de la boca Larghezza del morso	Schaftlänge Length of shaft Longeur de la tige Longitud del vástago Lunghezza dell'asta	90°	40°	40°	Auswerfer Ejector Ejecteur Eyetor Estrattore
1,0 mm	18 cm	27.3410.10	27.3411.10	27.3413.10	-
1,5 mm	18 cm		27.3411.15		-
2,0 mm	18 cm	27.3410.20	27.3411.20	27.3413.20	+
2,5 mm	18 cm		27.3411.25		+
3,0 mm	18 cm	27.3410.30	27.3411.30	27.3413.30	+
4,0 mm	18 cm	27.3410.40	27.3411.40	27.3413.40	+
5,0 mm	18 cm	27.3410.50	27.3411.50	27.3413.50	+
1,0 mm	20 cm	27.3420.10	27.3421.10	27.3423.10	-
2,0 mm	20 cm	27.3420.20	27.3421.20	27.3423.20	+
3,0 mm	20 cm	27.3420.30	27.3421.30	27.3423.30	+
4,0 mm	20 cm	27.3420.40	27.3421.40	27.3423.40	+
5,0 mm	20 cm	27.3420.50	27.3421.50	27.3423.50	+
1,0 mm	23 cm	27.3430.10	27.3431.10		-
2,0 mm	23 cm	27.3430.20	27.3431.20		+
3,0 mm	23 cm	27.3430.30	27.3431.30		+
4,0 mm	23 cm	27.3430.40	27.3431.40		+
5,0 mm	23 cm	27.3430.50	27.3431.50		+

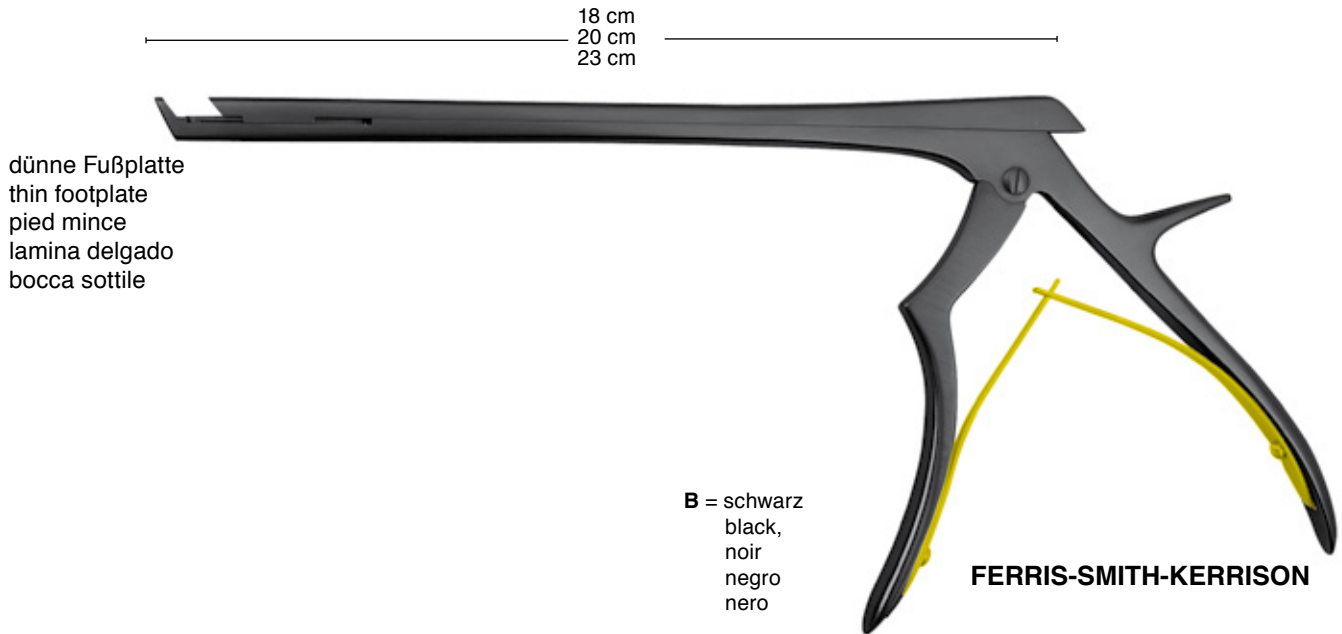

Bissbreite Width of bite Largeur des mors Anchura de la boca Larghezza del morso	Schaftlänge Length of shaft Longeur de la tige Longitud del vástago Lunghezza dell'asta	90°	40°	40°	Auswerfer Ejector Ejecteur Eyector Estrattore
1,0 mm	18 cm	27.3410.10B	27.3411.10B	27.3413.10B	-
1,5 mm	18 cm		27.3411.15B		-
2,0 mm	18 cm	27.3410.20B	27.3411.20B	27.3413.20B	+
2,5 mm	18 cm		27.3411.25B		+
3,0 mm	18 cm	27.3410.30B	27.3411.30B	27.3413.30B	+
4,0 mm	18 cm	27.3410.40B	27.3411.40B	27.3413.40B	+
5,0 mm	18 cm	27.3410.50B	27.3411.50B	27.3413.50B	+
1,0 mm	20 cm	27.3420.10B	27.3421.10B	27.3423.10B	-
2,0 mm	20 cm	27.3420.20B	27.3421.20B	27.3423.20B	+
3,0 mm	20 cm	27.3420.30B	27.3421.30B	27.3423.30B	+
4,0 mm	20 cm	27.3420.40B	27.3421.40B	27.3423.40B	+
5,0 mm	20 cm	27.3420.50B	27.3421.50B	27.3423.50B	+
1,0 mm	23 cm	27.3430.10B	27.3431.10B		-
2,0 mm	23 cm	27.3430.20B	27.3431.20B		+
3,0 mm	23 cm	27.3430.30B	27.3431.30B		+
4,0 mm	23 cm	27.3430.40B	27.3431.40B		+
5,0 mm	23 cm	27.3430.50B	27.3431.50B		+

LAMINEKTOMIE-STANZEN
LAMINECTOMY PUNCHES
PINCES EMPORTE-PIECES A LAMINECTOMIE
PINZAS CORTANTES PARA LAMINECTOMIA
PINZE PER LAMINECTOMIA

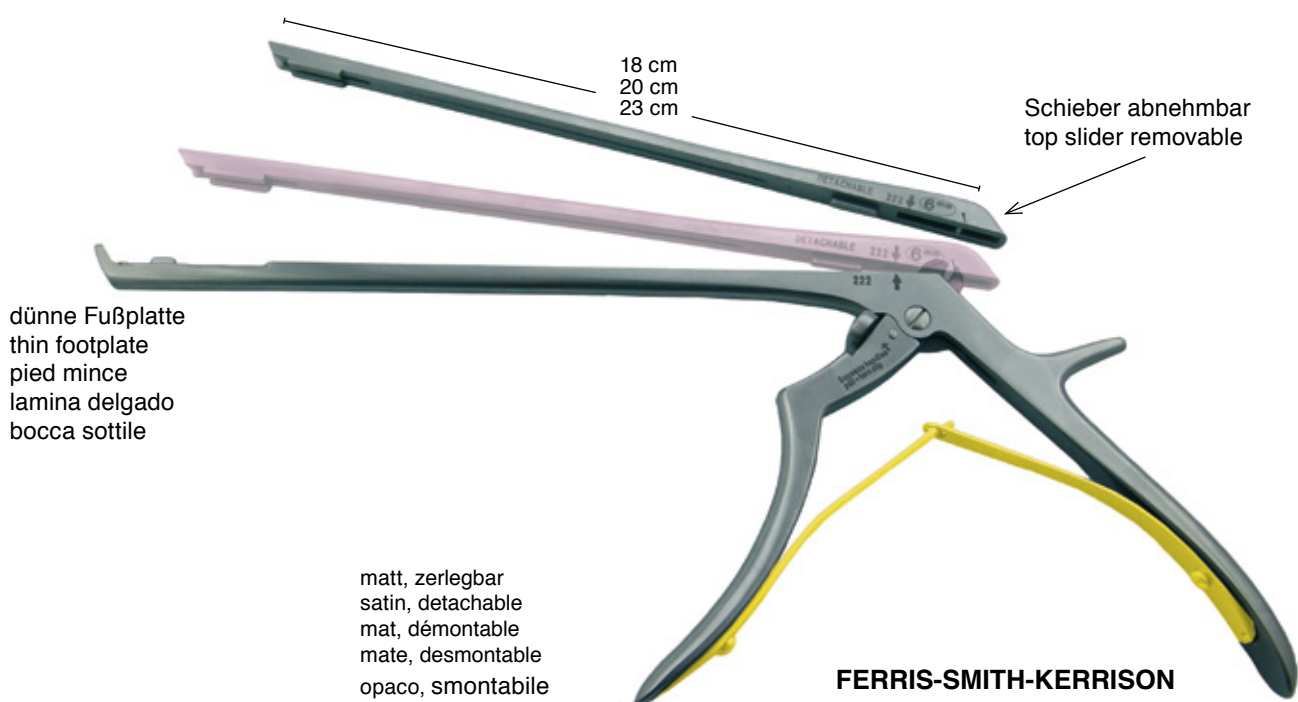

FERRIS-SMITH-KERRISON

Bissbreite
Width of bite
Largeur des mors
Anchura de la boca
Larghezza del morso

Schaftlänge
Length of shaft
Longeur de la tige
Longitud del vástago
Lunghezza dell'asta

90°

40°

40°



Auswerfer
Ejector
Ejecteur
Ejector
Estrattore



1,0 mm	18 cm	27.3410.10D	27.3411.10D	27.3413.10D	-
1,5 mm	18 cm		27.3411.15D		-
2,0 mm	18 cm	27.3410.20D	27.3411.20D	27.3413.20D	+
2,5 mm	18 cm		27.3411.25D		+
3,0 mm	18 cm	27.3410.30D	27.3411.30D	27.3413.30D	+
4,0 mm	18 cm	27.3410.40D	27.3411.40D	27.3413.40D	+
5,0 mm	18 cm	27.3410.50D	27.3411.50D	27.3413.50D	+
1,0 mm	20 cm	27.3420.10D	27.3421.10D	27.3423.10D	-
2,0 mm	20 cm	27.3420.20D	27.3421.20D	27.3423.20D	+
3,0 mm	20 cm	27.3420.30D	27.3421.30D	27.3423.30D	+
4,0 mm	20 cm	27.3420.40D	27.3421.40D	27.3423.40D	+
5,0 mm	20 cm	27.3420.50D	27.3421.50D	27.3423.50D	+
1,0 mm	23 cm	27.3430.10D	27.3431.10D		-
2,0 mm	23 cm	27.3430.20D	27.3431.20D		+
3,0 mm	23 cm	27.3430.30D	27.3431.30D		+
4,0 mm	23 cm	27.3430.40D	27.3431.40D		+
5,0 mm	23 cm	27.3430.50D	27.3431.50D		+

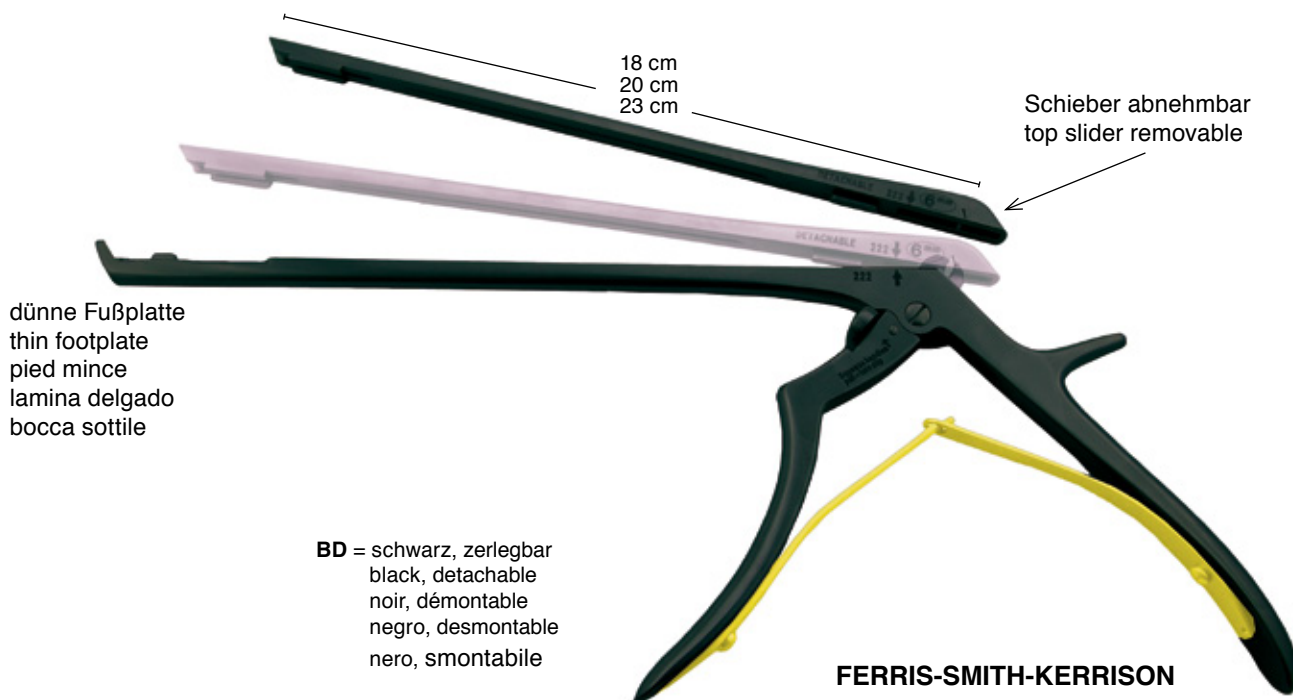

dünne Fußplatte
 thin footplate
 pied mince
 lamina delgado
 bocca sottile

BD = schwarz, zerlegbar
 black, detachable
 noir, démontable
 negro, desmontable
 nero, smontabile

FERRIS-SMITH-KERRISON

Bissbreite Width of bite Largeur des mors Anchura de la boca Larghezza del morso	Schaftlänge Length of shaft Longeur de la tige Longitud del vástago Lunghezza dell'asta	90°	40°	40°	Auswerfer Ejector Ejecteur Ejector Estrattore
1,0 mm	18 cm	27.3410.10BD	27.3411.10BD	27.3413.10BD	-
1,5 mm	18 cm		27.3411.15BD		-
2,0 mm	18 cm	27.3410.20BD	27.3411.20BD	27.3413.20BD	+
2,5 mm	18 cm		27.3411.25BD		+
3,0 mm	18 cm	27.3410.30BD	27.3411.30BD	27.3413.30BD	+
4,0 mm	18 cm	27.3410.40BD	27.3411.40BD	27.3413.40BD	+
5,0 mm	18 cm	27.3410.50BD	27.3411.50BD	27.3413.50BD	+
1,0 mm	20 cm	27.3420.10BD	27.3421.10BD	27.3423.10BD	-
2,0 mm	20 cm	27.3420.20BD	27.3421.20BD	27.3423.20BD	+
3,0 mm	20 cm	27.3420.30BD	27.3421.30BD	27.3423.30BD	+
4,0 mm	20 cm	27.3420.40BD	27.3421.40BD	27.3423.40BD	+
5,0 mm	20 cm	27.3420.50BD	27.3421.50BD	27.3423.50BD	+
1,0 mm	23 cm	27.3430.10BD	27.3431.10BD		-
2,0 mm	23 cm	27.3430.20BD	27.3431.20BD		+
3,0 mm	23 cm	27.3430.30BD	27.3431.30BD		+
4,0 mm	23 cm	27.3430.40BD	27.3431.40BD		+
5,0 mm	23 cm	27.3430.50BD	27.3431.50BD		+

KNOCHENSTANZEN, RONGEURE
BONE PUNCHES, RONGEURS
PINCES OSSEUSE, RONGEURS
PINZAS PARA HUSEOS
PINZE OSTEOTOMI

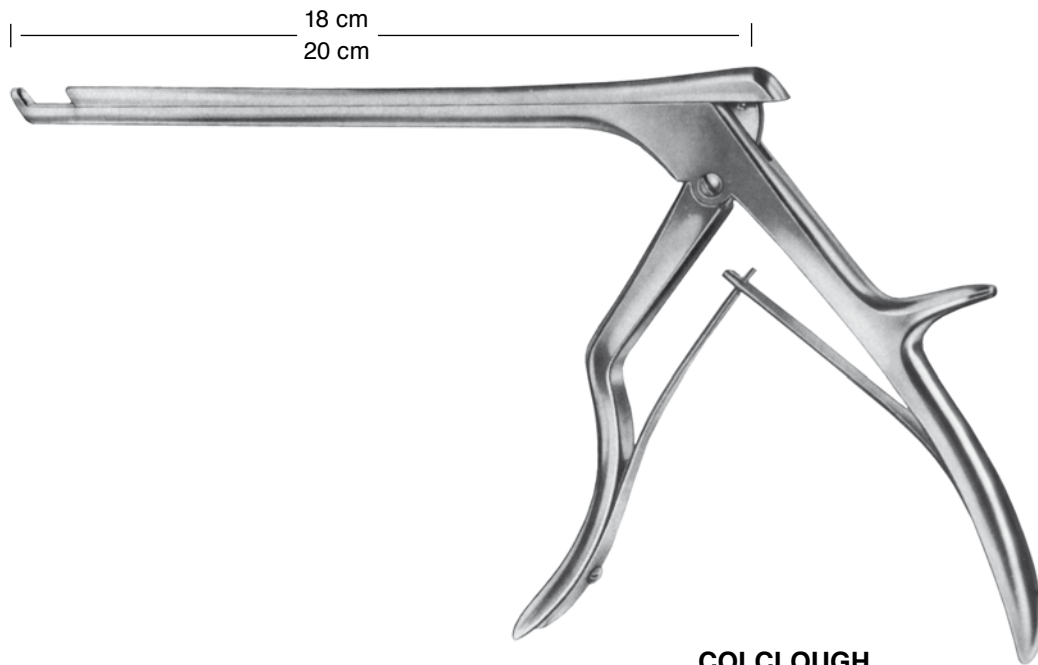

COLCLOUGH

Bissbreite
 Width of bite
 Largeur des mors
 Anchura de la boca
 Larghezza del morso

Schaftlänge
 Length of shaft
 Longueur de la tige
 Longitud del vástago
 Lunghezza dell'asta



		90°	90°	40°
3,0 mm	18 cm	27.1813	27.1843	27.1873
5,0 mm	18 cm	27.1815	27.1845	27.1875
3,0 mm	20 cm	27.1823	27.1853	27.1883
5,0 mm	20 cm	27.1825	27.1855	27.1885

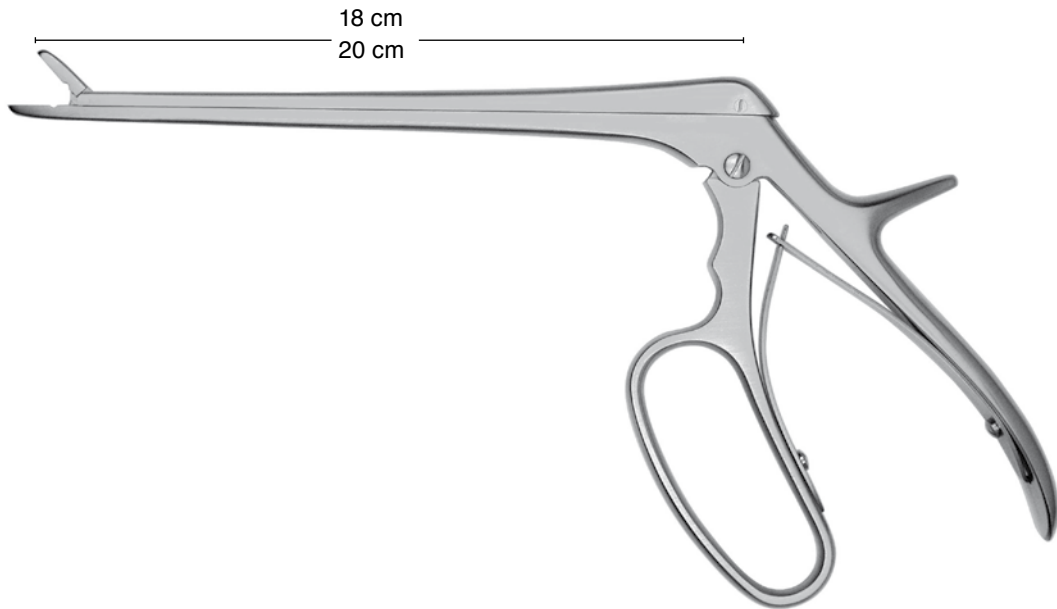

FERRIS-SMITH-CUSHING

Bissbreite
 Width of bite
 Largeur des mors
 Anchura de la boca
 Larghezza del morso

Schaftlänge
 Length of shaft
 Longueur de la tige
 Longitud del vástago
 Lunghezza dell'asta



2,0x10 mm	18 cm	27.3510.20	27.3511.20	27.3513.20
3,0x10 mm	18 cm	27.3510.30	27.3511.30	27.3513.30
4,0x10 mm	18 cm	27.3510.40	27.3511.40	27.3513.40
5,0x10 mm	18 cm	27.3510.50	27.3511.50	27.3513.50
6,0x12 mm	18 cm	27.3510.60	27.3511.60	27.3513.60
2,0x10 mm	20 cm	27.3520.20	27.3521.20	27.3523.20
3,0x10 mm	20 cm	27.3520.30	27.3521.30	27.3523.30
4,0x10 mm	20 cm	27.3520.40	27.3521.40	27.3523.40
5,0x10 mm	20 cm	27.3520.50	27.3521.50	27.3523.50
6,0x12 mm	20 cm	27.3520.60	27.3521.60	27.3523.60

**KNOCHENSTANZEN, RONGEURE
BONE PUNCHES, RONGEURS
PINCES OSSEUSE, RONGEURS
PINZAS PARA HUSEOS
PINZE OSTEOTOMI**

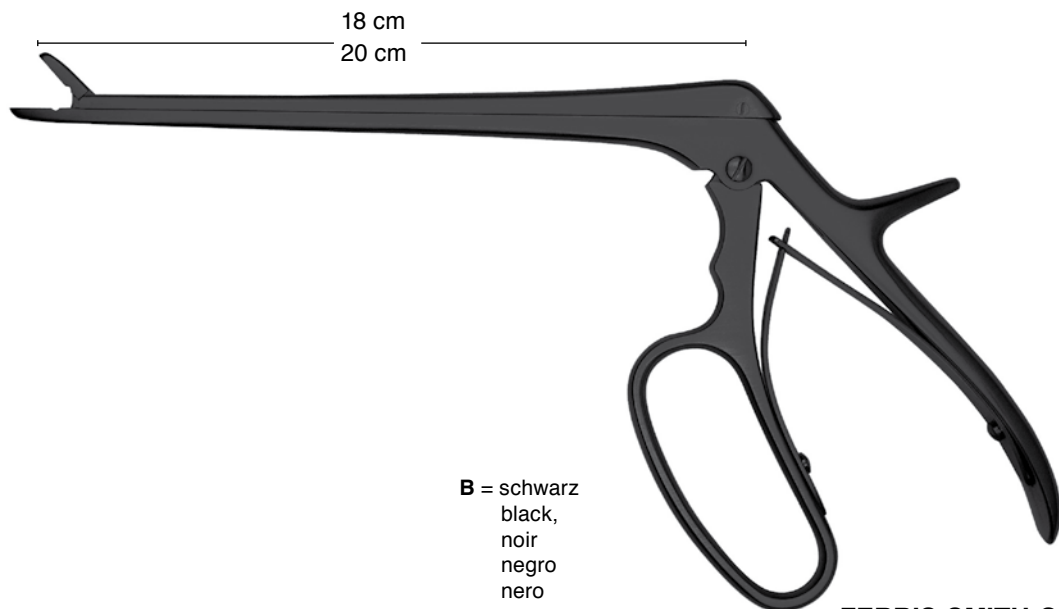

FERRIS-SMITH-CUSHING

Bissbreite
Width of bite
Largeur des mors
Anchura de la boca
Larghezza del morso

Schaftlänge
Length of shaft
Longeur de la tige
Longitud del vástago
Lunghezza dell'asta



2,0x10 mm	18 cm	27.3510.20B	27.3511.20B	27.3513.20B
3,0x10 mm	18 cm	27.3510.30B	27.3511.30B	27.3513.30B
4,0x10 mm	18 cm	27.3510.40B	27.3511.40B	27.3513.40B
5,0x10 mm	18 cm	27.3510.50B	27.3511.50B	27.3513.50B
6,0x12 mm	18 cm	27.3510.60B	27.3511.60B	27.3513.60B
2,0x10 mm	20 cm	27.3520.20B	27.3521.20B	27.3523.20B
3,0x10 mm	20 cm	27.3520.30B	27.3521.30B	27.3523.30B
4,0x10 mm	20 cm	27.3520.40B	27.3521.40B	27.3523.40B
5,0x10 mm	20 cm	27.3520.50B	27.3521.50B	27.3523.50B
6,0x12 mm	20 cm	27.3520.60B	27.3521.60B	27.3523.60B

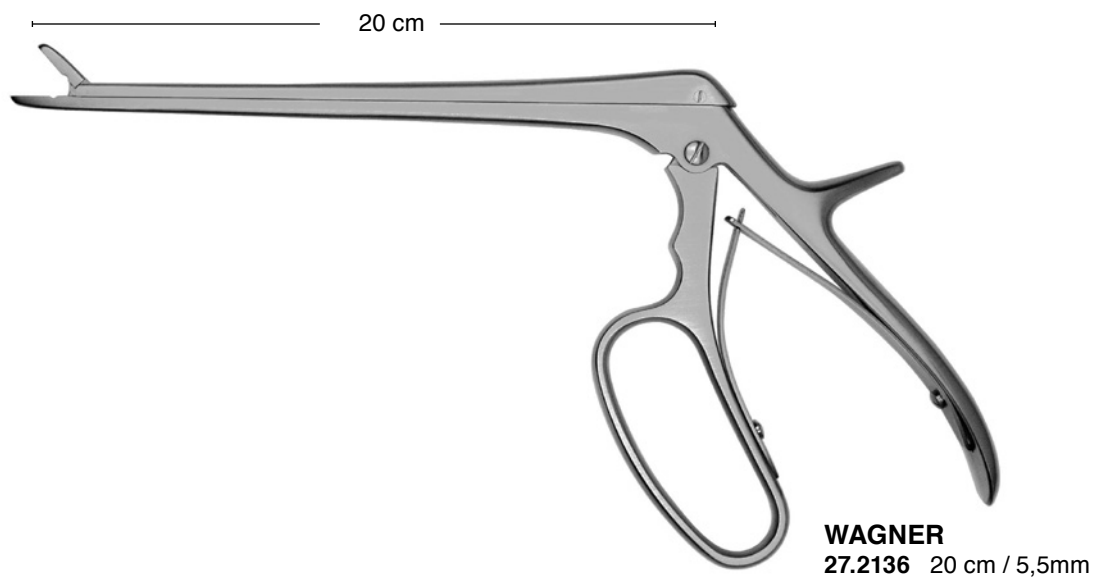
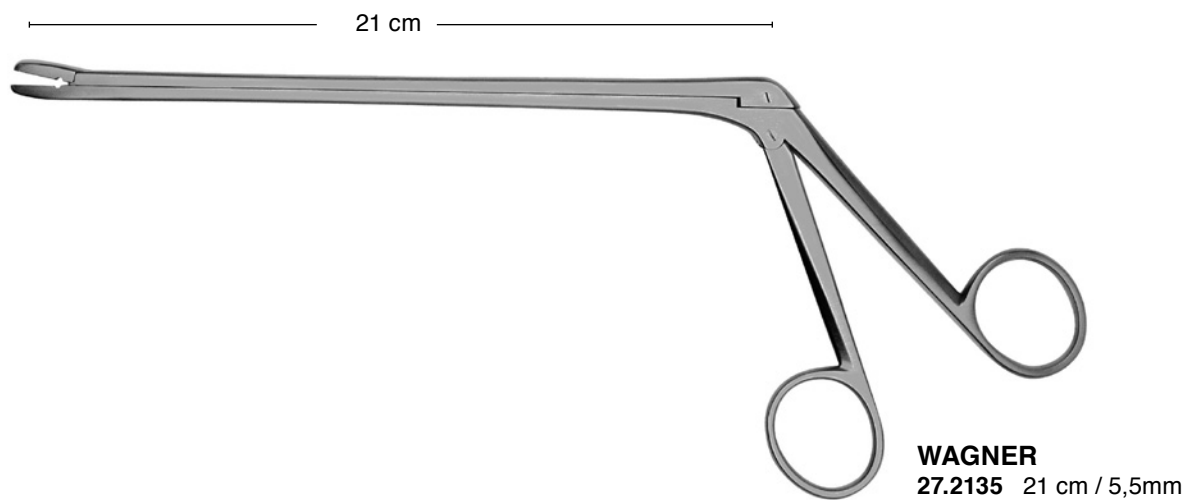
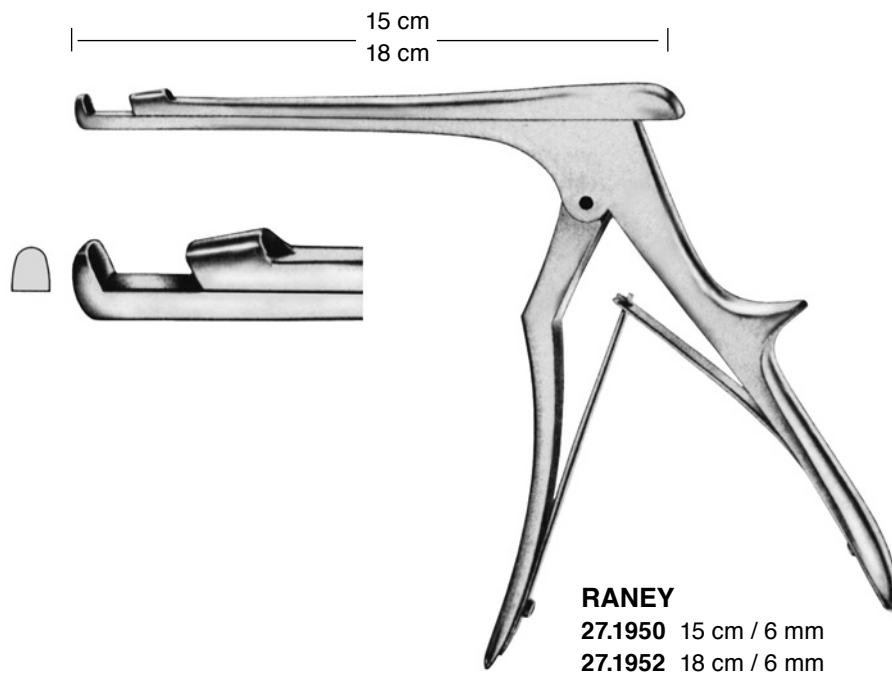

LAMINEKTOMIE-ZANGEN
LAMINECTOMY RONGEURS
PINCES EMPORTE-PIECES A LAMINECTOMIE
PINZAS CONTANTES PARA LAMINECTOMIA
PINZE PER LAMINECTOMIA

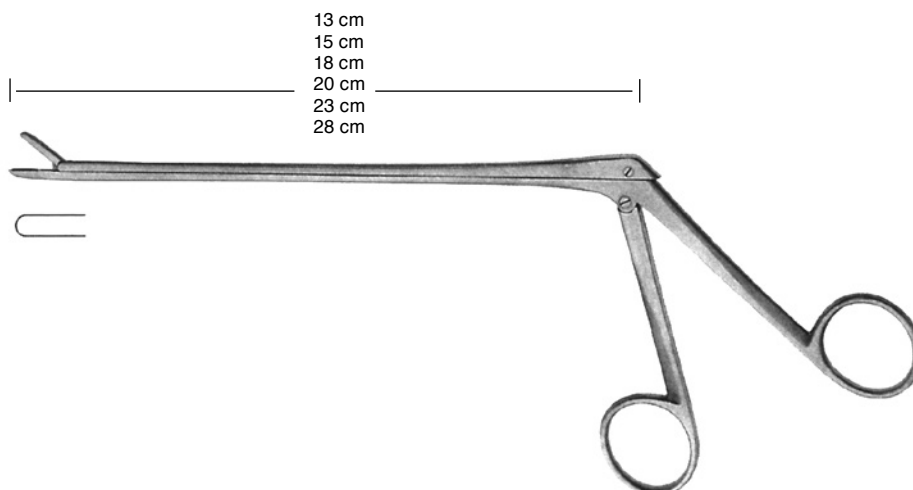

CUSHING

1,5 mm / 2 mm



13 cm	2,0x10 mm	27.2149	27.2148	27.2147
15 cm	2,0x10 mm	27.2150	27.2151	27.2152
18 cm	1,5x10 mm	27.2154		
18 cm	2,0x10 mm	27.2155	27.2156	27.2157
20 cm	2,0x10 mm	27.2155.20	27.2156.20	27.2157.20
23 cm	2,0x10 mm	27.2155.23	27.2156.23	27.2157.23
28 cm	2,0x10 mm	27.2155.28	27.2156.28	27.2157.28

LOVE-GRUENWALD

3 mm

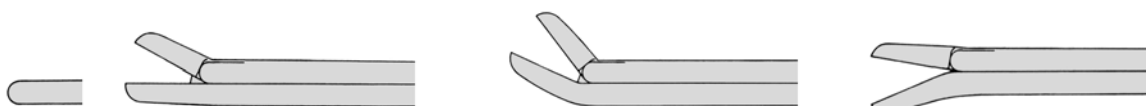

13 cm	3,0x10 mm	27.2159	27.2163	27.2164
15 cm	3,0x10 mm	27.2160	27.2161	27.2162
18 cm	3,0x10 mm	27.2165	27.2166	27.2167
20 cm	3,0x10 mm	27.2165.20	27.2166.20	27.2167.20
23 cm	3,0x10 mm	27.2165.23	27.2166.23	27.2167.23
28 cm	3,0x10 mm	27.2165.28	27.2166.28	27.2167.28

SPURLING

4 mm

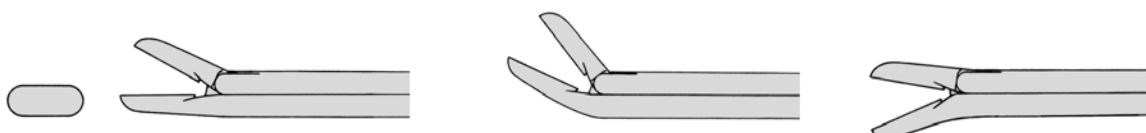

13 cm	4,0x10 mm	27.2169		
15 cm	4,0x10 mm	27.2170	27.2171	27.2172
18 cm	4,0x10 mm	27.2175	27.2176	27.2177
20 cm	4,0x10 mm	27.2175.20	27.2176.20	27.2177.20
23 cm	4,0x10 mm	27.2175.23	27.2176.23	27.2177.23
28 cm	4,0x10 mm	27.2175.28	27.2176.28	27.2177.28

LAMINEKTOMIE-ZANGEN
LAMINECTOMY RONGEURS
PINCES EMPORTE-PIECES A LAMINECTOMIE
PINZAS CONTANTES PARA LAMINECTOMIA
PINZE PER LAMINECTOMIA



OLDBERG

18 cm
27.2180

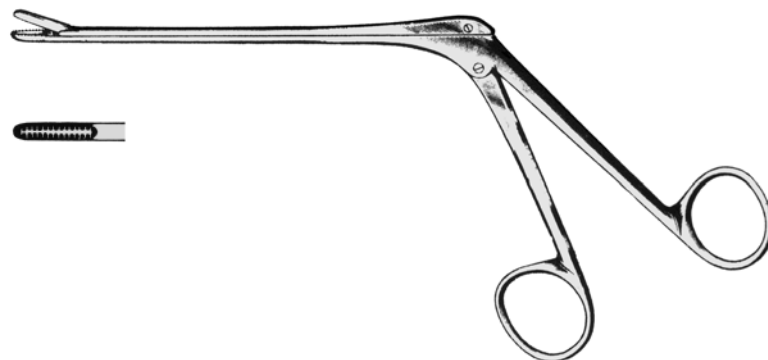

SCHLESINGER

15 cm
27.2186 2 x 10 mm
27.2187 3 x 10 mm
27.2188 4 x 10 mm
27.2189 6 x 10 mm



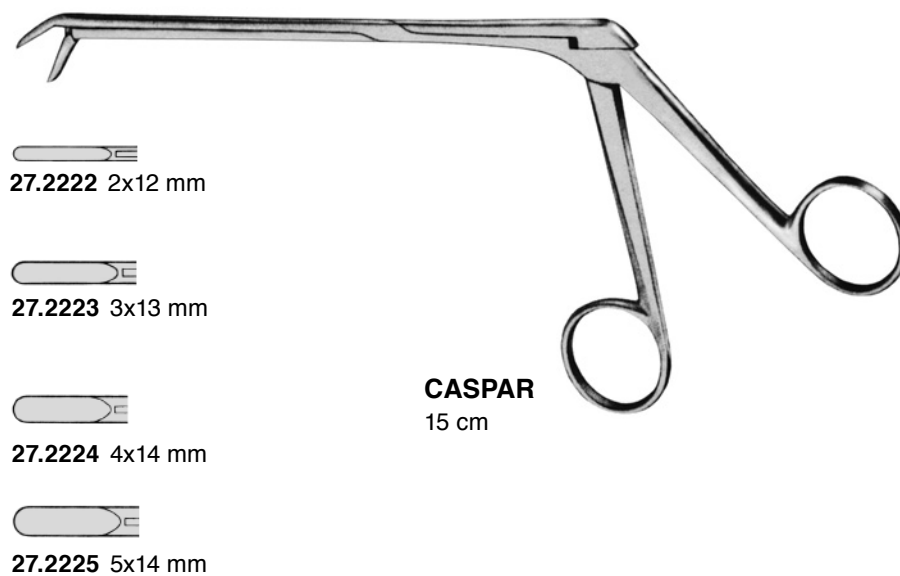
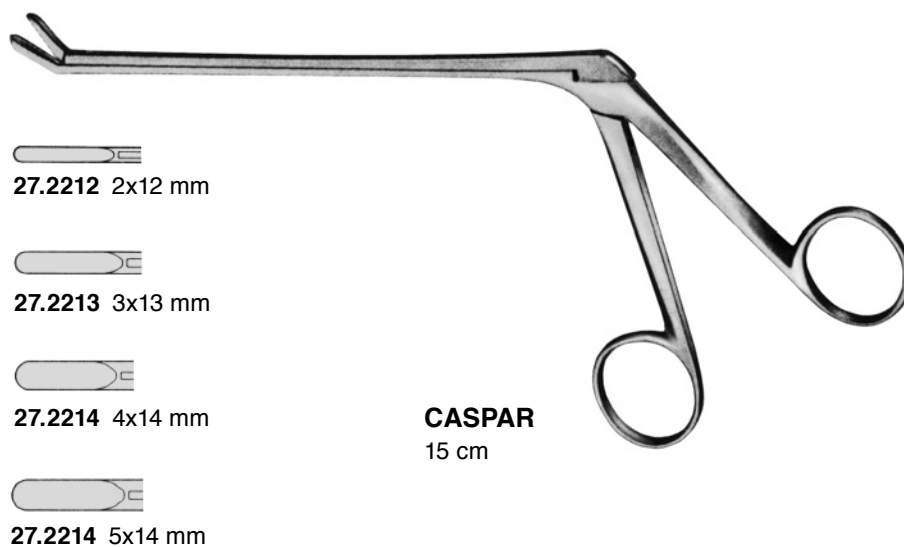
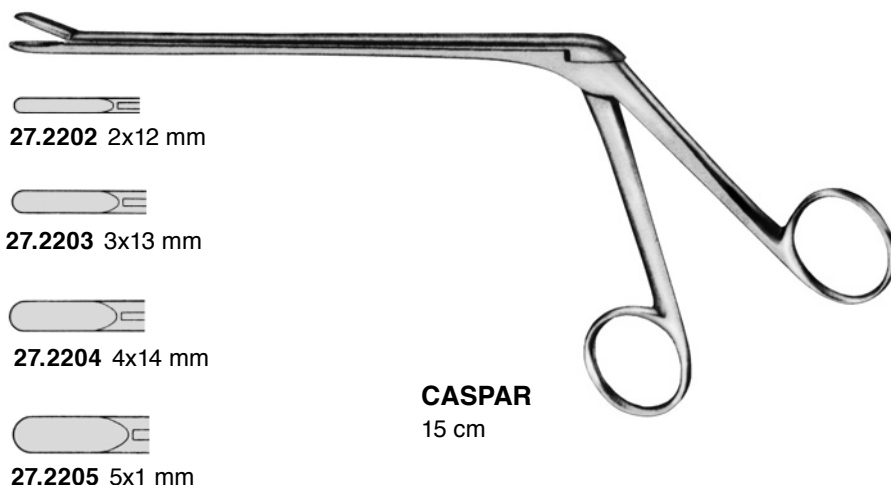

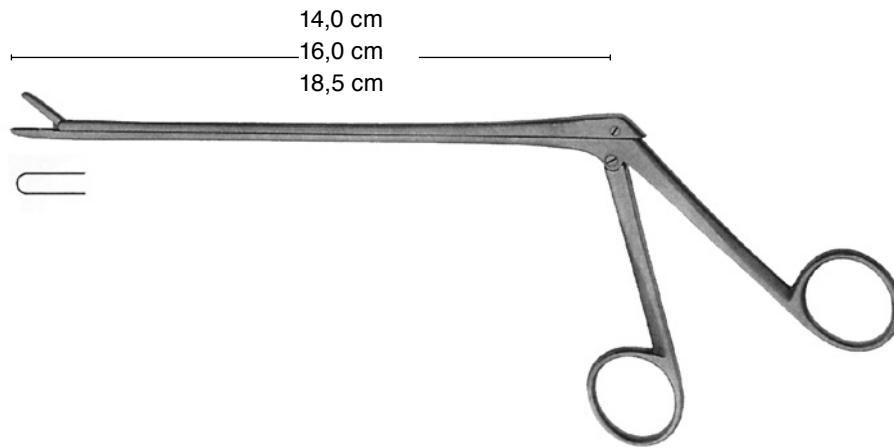
LAMINEKTOMIE-ZANGEN
LAMINECTOMY RONGEURS
PINCES EMPORTE-PIECES A LAMINECTOMIE
PINZAS CONTANTES PARA LAMINECTOMIA
PINZE PER LAMINECTOMIA





CASPAR

Schaftlänge
 Length of shaft
 Longueur de la tige
 Longitud del vástago
 Lunghezza dell'asta

	14,0 cm	16,0 cm	18,5 cm
	27.6502 2x12 mm	27.6532 2x12 mm	27.6562 2x12 mm
	27.6503 3x12 mm	27.6533 3x12 mm	27.6563 3x12 mm
	27.6504 4x14 mm	27.6534 4x14 mm	27.6564 4x14 mm
	27.6505 5x14 mm	27.6535 5x14 mm	27.6565 5x14 mm
	27.6506 2x16 mm	27.6536 2x16 mm	27.6566 2x16 mm

LAMINEKTOMIE-ZANGEN
LAMINECTOMY RONGEURS
PINCES EMPORTE-PIECES A LAMINECTOMIE
PINZAS CONTANTES PARA LAMINECTOMIA
PINZE PER LAMINECTOMIA

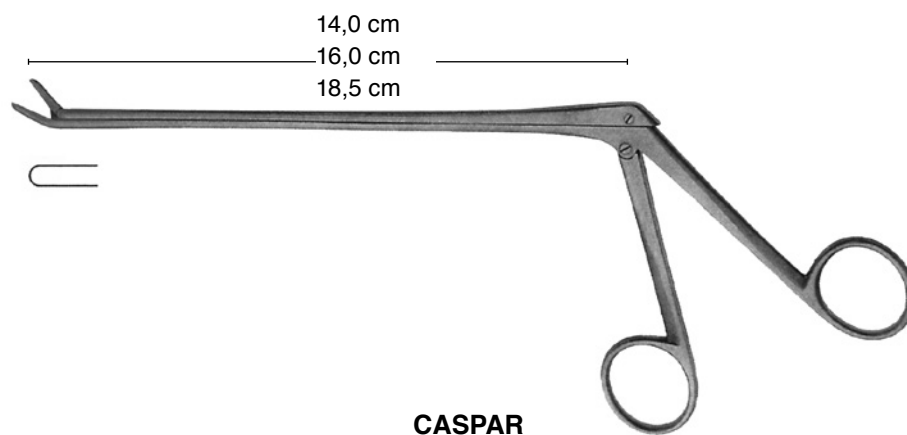

Schaftlänge
 Length of shaft
 Longueur de la tige
 Longitud del vástago
 Lunghzza dell'asta

14,0 cm



27.6512 2x12 mm



27.6513 3x12 mm



27.6514 4x14 mm



27.6515 5x14 mm

16,0 cm



27.6542 2x12 mm



27.6543 3x12 mm



27.6544 4x14 mm



27.6545 5x14 mm

18,5 cm



27.6572 2x12 mm



27.6573 3x12 mm







27.6574 4x14 mm

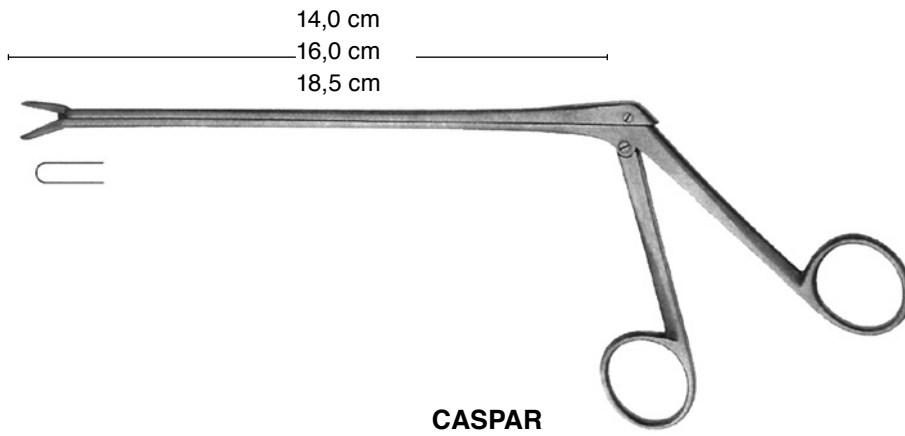

27.6575 5x14 mm

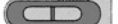

Schaftlänge
 Length of shaft
 Longueur de la tige
 Longitud del vástago
 Lunghezza dell'asta

	14,0 cm	16,0 cm	18,5 cm
	27.6522 2x12 mm	27.6552 2x12 mm	27.6582 2x12 mm
	27.6523 3x12 mm	27.6553 3x12 mm	27.6583 3x12 mm
	27.6524 4x14 mm	27.6554 4x14 mm	27.6584 4x14 mm
	27.6525 5x14 mm	27.6555 5x14 mm	27.6585 5x14 mm

HYPOPHYSENZANGEN UND -PINZETTEN
PITUITARY FORCEPS
PINCES POUR L'HYPOPHYSE
PINZAS PARA HIPOFISIS
PINZE PER IPOFISI

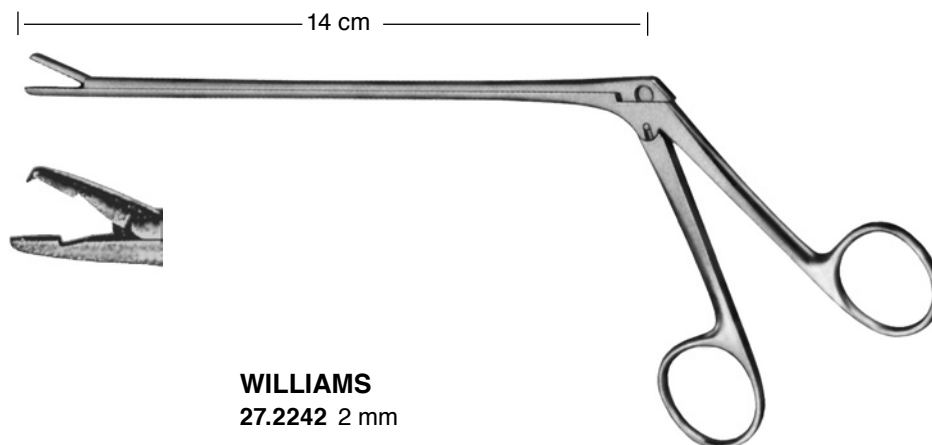
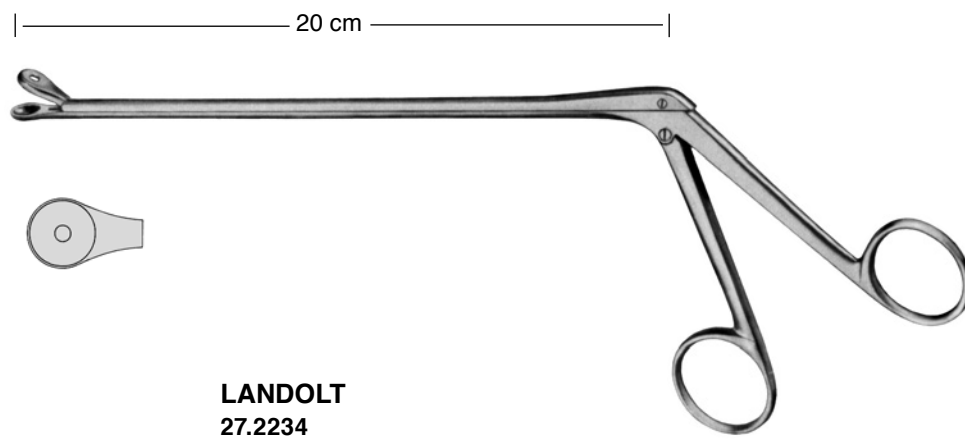
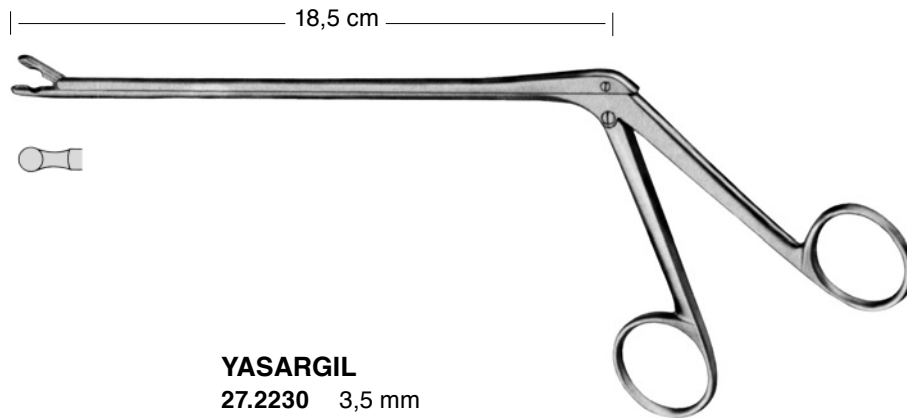

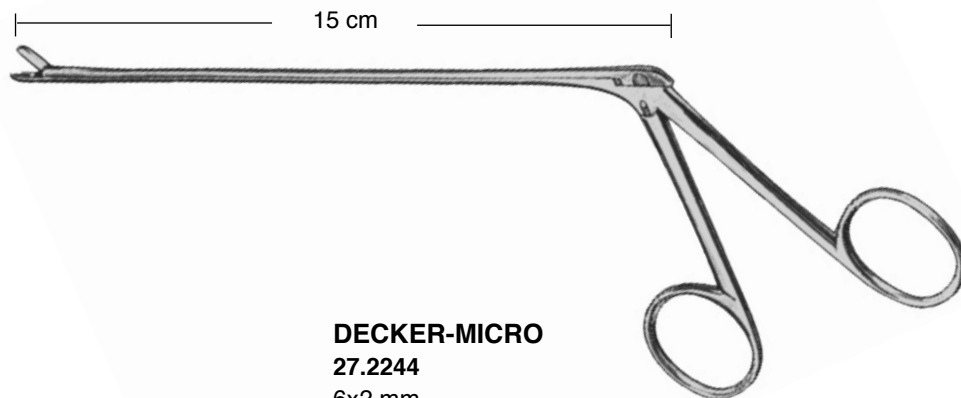

DECKER-MICRO
27.2244
6x2 mm

27.2245
nach links gebogen
curved to left
courbe à gauche
curva a la izquierda
curvo a sinistra

27.2246
nach rechts gebogen
curved to right
courbe à droite
curva a la derecha
curvo a destra

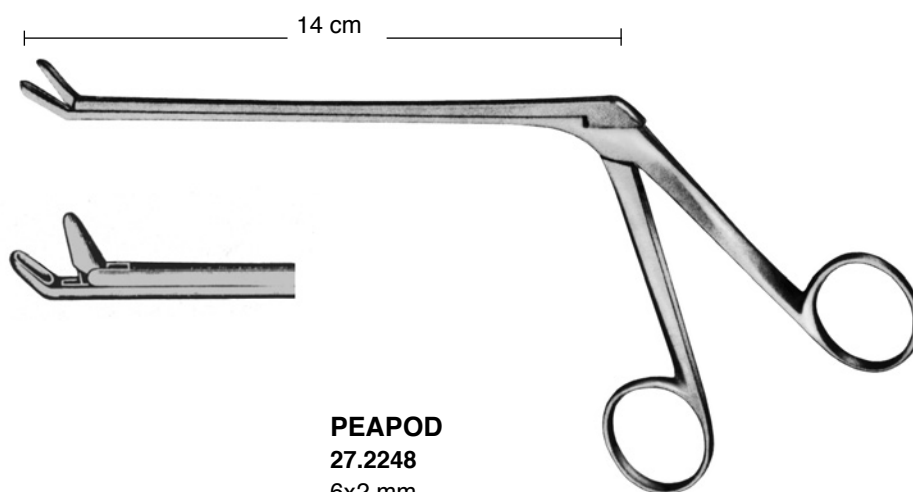

PEAPOD
27.2248
6x2 mm

HYPOPHYSENZANGEN UND -PINZETTEN
PITUITARY FORCEPS
PINCES POUR L'HYPOPHYSE
PINZAS PARA HIPOFISIS
PINZE PER IPOFISI



ADSON
 18,5 cm

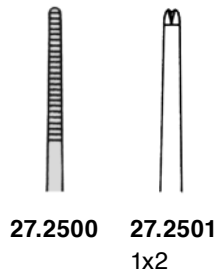

HOEN
 20cm

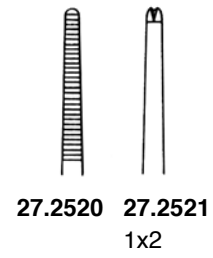

Hypophysenpinzetten
 Hypophyseal forceps
 Pincès à hypophyse
 Pinzas para hipofisis
 Pinze per ipofisi



ADSON
 27.2540 23 cm



ADSON
 27.2541 23 cm



ADSON
 27.2542 23 cm

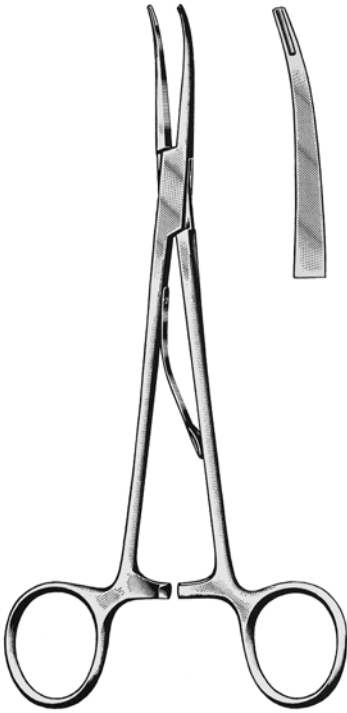

McKENZIE
27.2701 15 cm
27.2703 19 cm

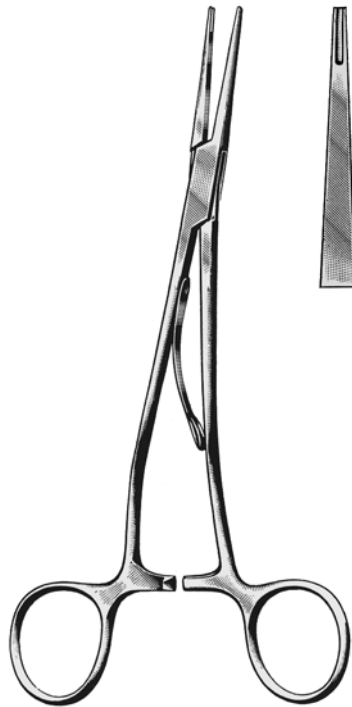

McKENZIE
27.2702 15 cm
27.2704 19 cm



McKENZIE
27.2740
100 Stück, Silber
100 pieces, Silver
100 pieces, argent
100 piezas, plata
100 pezzi, argento



McKENZIE
27.2745



RANEY
27.2770 17 cm



RANEY
27.2780
12 Stück
12 pieces
12 pieces
12 piezas
12 pezzi

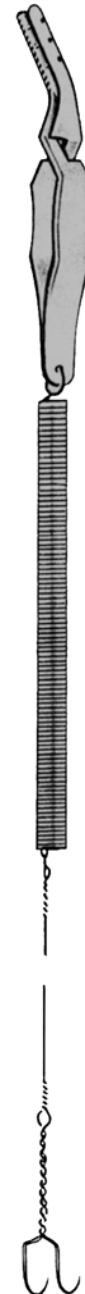

Federhaken
zur Galea-Fixation
Spring hooks
for galea fixation
Crochets à molle
pour fixer la galea
Ganchos con
muelle para la
Gancio a molla per
fissare la galea

YASARGIL
27.2800
31 cm / 7 mm Ø
27.2802
41 cm / 9 mm Ø

